

■ Connectivity...for  
Business-Critical Continuity™

## **Patching Products, RF Connectors and Cable Assemblies**

*Product Catalog*



# CONTENTS

## THE TROMPETER DIFFERENCE

RF Interconnect Products	2
ISO 9001 Registration	3
Warranty Information	3

## TWINAX/TRIAX CONNECTORS

Mil-Std-1553B Data Bus General Specifications Guide	4-5
---	-----

### 70/370 Series

MIL-C-49142 QPL'd Connectors	7
TRB/TRT Miniature Plugs & Jacks	8
TRB/TRT Miniature Bulkhead Jacks	9
Miniature Circuit Board Jacks	10
TRB Series Pad, Paralleling Jacks, & T Adapter	11
Twinax/Triax Terminations & RFI Caps	12
Standard Twinax/Triax Patching	13-14
Standard Twinax/Triax Normal-Thru Patch Jacks	15
Subminiature Twinax/Triax Patching	16
Standard & Subminiature Twinax/Triax Looping Plugs	17
Hermetically Sealed Connectors	18
Mating Twinax Size 8 Contacts	19

### 150/3150 Series

TRS/TTM Subminiature Jacks and Plugs	20
TRS/TTM Subminiature Bulkhead Jacks	21-22
Subminiature Bulkhead Jacks, Adapters, & Push-on	23

### 450 Series

Concentric Twinax Connectors	24-25
------------------------------	-------

### 80/380 Series

TRC/TRN Standard Twinax/Triax Threaded	26
--	----

### 30/330 Series

TWBNC/TWTNC, Two-pin Polarized Connectors	27
---	----

## COAX CONNECTORS

### 20/220 Series

Miniature Coax BNC Plugs & Jacks	29
Miniature Coax BNC Bulkhead Jacks	30
Coax Circuit Board Jacks	31-37

### 250 Series

Mini-BNC Coax Plugs & Jacks	38
-----------------------------	----

### 40/240 Series

TNC Miniature Coax Threaded	39
TNC Bulkhead Jacks, Miniature Coax Threaded	40

### 120 Series

BNC/TNC Miniature Push-on Jacks & Plugs	41
---	----

### 1.6/5.6 DIN Connectors

Miniature Coax DIN Connectors	42
Coaxial Ground Filter Bulkhead Jacks	43

### "N" & "F" Connectors

90 Series Coax "N" Connectors	44-45
130 Series Coax "F" Connectors	45-47
Low VSWR Coax Connectors	48

### 50/350 Series

TPS/TCM Subminiature Coax Threaded Jacks & Plugs	49
--	----

## PATCHING PRODUCTS

High Frequency Video Patching	50-52
Standard Coax Patching	53-55
Mini-WECO Coax Patch Plugs	56-57
Audio Patching	58
50Ω Miniature Coax Patching	59
Panel Specifications	60
Distribution Panels	61
Standard/Miniature Panels	62-63
"D" Mounting Hole Specifications	63

### Custom Cable Assemblies

64-66

### Terminations & RFI Caps

Coax Terminations & RFI Caps	67
Chain Options	67
Stainless Steel Rope for "D" Ring Option	67

### Adapters (Custom and Standard)

Adapter Circuitry Schematics	68
Coax to Coax Adapter Table	69
Coax/Twinax/Triax Adapter Table	70-71

## TOOLS & ACCESSORIES

Cable Strippers	72
Crimp Tools	73
Cable Assembly Testers	74
Tool Kit/Bulk Packaging	75

## APPENDIX

Trompeter Cable Specifications	76-77
Connector Compatibility Table	78
General Material/ Finish Specifications	79
BNC Coax Tool/Wrench Crimp Assembly Illustrations	80
Bend Relief Boots	81
Cable Group Table	82-124

## TECHNICAL PAPERS

Space Qualified Connectors	125
Digital Signal Integrity	126-128
Signal Transmission in High Density/ High Frequency Applications	129-130
Electronic Systems Wiring & Cable	131-136
Custom Products Fax Request Form	137

## INDEX

Part Number Index	138-140
-------------------	---------

## RF INTERCONNECT PRODUCTS

### Introduction

Established in 1960, Trompeter manufactures high-reliability coax, twinax, and triax connectors, cable, and assembly/termination tools. We also offer a broad line of patch panel insertion-controlled interconnect modules and a rapid-response cable assembly service. We are an ISO 9001:2000 registered company, and we serve the Telecommunications, Broadcasting, and Military/Aerospace markets internationally.

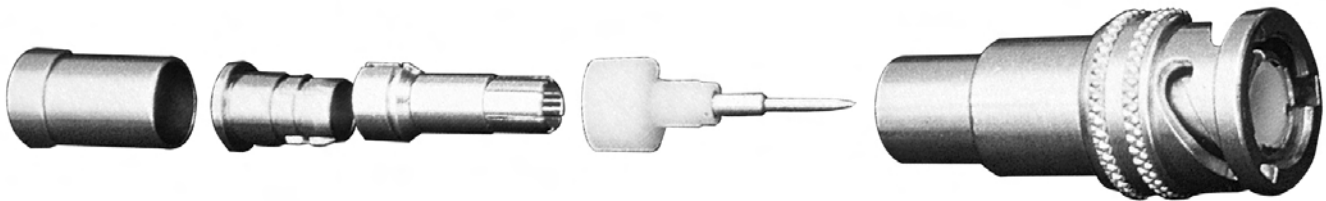

### MIL-STD-1553B Digital Data Bus Applications

Twinax /Triax connectors are used in military applications to protect data signals from extraneous noise through non-signal-carrying shielding. Interfacing connectors must provide contact surfaces isolated from each other and from their outer shields. MIL-STD-1553B addresses twinax applications for computerized/multiplexed digital data distribution systems servicing the many functions of Command, Control, Communications, Computers and Intelligence (C4I) which was originally designed for military aircraft. MIL-STD-1553B applications are found in military surface ships, battle tanks, helicopters, missiles, space vehicles, combat aircraft and in many ground applications such as data networks and perimeter security for airports, armories, and other government installations.

Using a single digital transmission cable instead of the heavy, complex, dedicated cable wiring harnesses of the past delivers great advantages in data throughput, automation, and weight savings – critical to the performance of state-of-the-art avionics. 75 ohm twinax cable was selected to deliver digital information with the required protection from magnetic, electrostatic, and electromagnetic pulse interference. Complete shielding of the twisted pair must be maintained along the transmission path and within all multi-pin connector electrical contacts.

Trompeter provides impedance-matched Twinax/Triax connectors and cable that improve the throughput and interference rejection of digital data transmission systems. Our components meet or exceed MIL-STD-1553B requirements (for airborne and ground checkout) and MIL-STD-1760 “External Stores.”

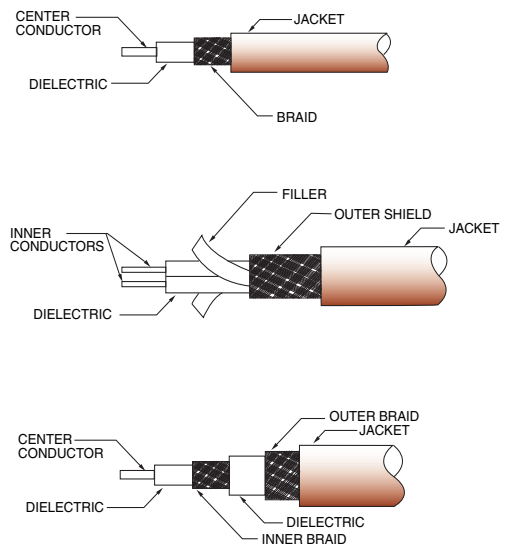

# TROMPETER QUALITY

## Quality Standard and Custom Components

For over 45 years, we at Trompeter have delivered innovations in standard and custom component designs that continue to exceed your performance expectations and mechanical requirements. The growth in our product line from 78 components in 1964 to more than 7,000 end items and 20,000 configurations is the result of our customers' validation of our engineering and manufacturing capabilities.

- Custom modifications that eliminate the need to compromise design integrity for cost savings.
- Field and battle-proven design quality and performance.
- Proven track record of meeting the most demanding performance requirements.

### *Why compromise your design?*

A minor modification might be an affordable solution to your design needs.

### *Why settle for less than Trompeter?*

Superior quality is paramount.

### *Trompeter components meet your most demanding requirements...*

When performance is critical.

When compromise is not an acceptable solution.

When cost savings detract from the integrity of your design.

## ISO 9001 Registration

ISO 9001 gives you the assurance that Trompeter has a solid, well-documented quality system in place. DET Norske Veritas (DNV) has certified that Trompeter engineering and manufacturing complies with established systems and policies. The ISO 9001 Quality System Standard outlines twenty elements of quality that we have addressed in order to meet registration requirements, and our adherence to these standards are validated by an accredited ISO 9001 auditor.

## Three-Year Warranty

All Trompeter products (except the battery-powered cable stripper) carry a three-year warranty against manufacturing defect or performance failure, and meet or exceed the highest industrial and governmental standards, such as Mil-C-39012 and MIL-C-49142. More importantly, Trompeter connectors are designed to meet your design specifications which are often more demanding and less forgiving. We have built our business on responding to your special needs for uncompromising performance in a world of increasing pressure from global competition. If, within three years of shipment, any of our products fail to meet your expectations due to defects in material or workmanship, we will gladly repair or replace it free of charge.

## Custom Product Requests

The products in this catalog are your first resource for solving your special interconnect problems. If you cannot find an adequate solution, then we invite you to consult with us for your special requirements. If you have an application which requires a new product, or a modification to one of our existing products, please fill out a copy of the Custom Products Request Form on page 137 and fax it to us. Please submit one complete form for each product requested. Requests for new/modified products are evaluated weekly, and you will receive a response within 3-5 working days.



## TWINAX/TRIAX CONNECTOR SPECIFICATIONS

Trompeter offers a broad line of connectors manufactured to meet or exceed the Mil-Specs governing twinax connectors. In fact, Mil-C-49142 was created from the Trompeter concentric twinax/triax connector design.

The following information reflects the specification requirements for each family of connectors in both twinax and triax applications. Use this chart to determine the proper connector type to be used in your application, based on the environment and electrical requirements of your design. Trompeter's technical support staff is available to answer any specification questions you may have.



MIL-Spec Triax Series	Trompeter Connector Series	Bayonet Typical Lug Count	Available Threaded	Gender	Equivalent Coax Series
TRB	70	3	Yes	Normal	BNC
TRC	80	2	Yes	Reverse	N
TRS	150	3	Yes	Normal	M-BNC
1553	450	3	Yes	Either	n/a

The following is the latest list from the MIL-STD-1553B supply:

### Trompeter Number

- PL75-47 or PL75C-201
- PL375C-201
- PL75C-201
- PL155AC-201
- PL3155AC-201
- PL155AC-201
- PL155AC-201
- PL3455ACS-201
- PL455ACP-201

### MIL-STD-1553B Data Bus General Specifications Guide

Characteristic Requirements	70 Series TRB/TRT	80 Series TRC/TRN	150 Series TRS/TTM	450 Series TCS
<b>Nominal Impedance</b>	Non-constant	Non-constant	Non-constant	Non-constant
<b>Frequency Range</b>	0-500 MHz	0-500 MHz	0-500 MHz	0-2 MHz
<b>Voltage Rating (max.) @ sea level</b>	400 VRMS	500 VRMS	400 VRMS	900 VRMS
<b>Voltage Rating (max.) @ 70,000 ft.</b>	100 VRMS	125 VRMS	100 VRMS	N/A
<b>Insulation Resistance</b>	5000 MΩ	5000 MΩ	5000 MΩ	5000 MΩ
<b>Dielectric Withstanding Voltage</b> (between center cond. & inter. cond.)	1200 VRMS	1500 VRMS	1200 VRMS	900 VAC
<b>Dielectric Withstanding Voltage</b> (between inter. cond. & outer cond.)	500 VRMS	500 VRMS	500 VRMS	N/A
<b>RF High Potential Withstanding Voltage</b> (between center cond. & inter. cond.)	800 VRMS	1000 VRMS	500 VRMS	900 VAC @ 60 Hz
<b>RF High Potential Withstanding Voltage</b> (between inter. & outer cond.)	200 VRMS @ 5-7.5 MHz	350 VRMS @ 5-7.5 MHz	125 VRMS	N/A

*Specifications continued on page 5...*

*\* Specifications are minimum unless otherwise stated. Trompeter connectors are designed to exceed all minimum specifications.*

# TWINAX/TRIAX CONNECTOR SPECIFICATIONS

## MIL-STD-1553B Data Bus General Specifications Guide (cont'd)

Characteristic Requirements	70 Series TRB/TRT	80 Series TRC/TRN	150 Series TRS/TTM	450 Series TCS
<b>Corona Level</b> (min.)	200 VRMS @ 70,000 ft.	375 VRMS @ 70,000 ft.	125 VRMS @ 70,000 ft.	250 VAC @ 50,000 ft.
<b>Rise Time Degradation</b> (max.)	400 rs	N/A	800 rs	800 rs
<b>Permeability of Nonmagnetic Material</b>	<2.0 mu except hermetic versions			
<b>Hermetic Seal</b> (Where Applicable)	<1 x 10 <sup>-8</sup> cc/sec	N/A	<1 x 10 <sup>-6</sup> cc/sec	N/A
<b>Connector Durability</b>	500 cycles minimum @ 12 cycles per minute max.			
<b>Temperature Range</b>	-65° to +165°C	-65° to +165°C	-65° to +200°C	-65° to 125°C
<b>Force to Engage and Disengage</b> <b>Longitudinal</b> (max.)	4 pounds	5 pounds	4 pounds	3 pounds
<b>Torque</b> (max.)	2.5 inch-pounds	4 inch-pounds	2.5 inch-pounds	2.5 inch-pounds
<b>Center Contact Retention</b> <b>Axial Force</b> (min.)				
<b>Plug</b>	6 pounds	6 pounds	4 pounds	6 pounds
<b>Jack</b>	6 pounds	6 pounds	2 pounds	6 pounds
<b>Coupling Proof Torque</b> (Threaded types only)	15 inch-pounds	15 inch-pounds	10 inch-pounds	N/A
<b>Coupling Mechanism Retention Force</b> (min.)	100 pounds	100 pounds	70 pounds	100 pounds
<b>Cable Retention Force</b> (min.)	40 pounds .200-.325 inch cable OD	65 pounds .242-.419 inch cable OD	40 pounds .120-.215 inch cable OD	40 pounds .120-.180 inch cable OD
<b>Salt Spray</b> (corrosion)	48 hrs minimum exposure (Standard nickel plating) 500 hrs minimum available (Call factory for plating types). Standard for 450 Series.			
<b>Moisture Resistance</b> (10 cycles)	Total 240 hour minimum exposure			
<b>Thermal Shock</b> (5 cycles) (No physical damage/Pass DWV)	Total 5 hours 50 minutes min -65°C to +85°C			-65°C to +125°C
<b>Specified Shock</b> (sawtooth waveform, within peak - 50g's, duration -11ms)	No discontinuity allowed. Velocity-change of shock pulse 10% of ideal value			
<b>Vibration, High-frequency</b> (36 cycles) (15g peak, 10-2000 Hz-10Hz in 20 minutes)	Total 12 hour minimum. No physical damage or loosening of parts. No discontinuity allowed.			

\* Specifications are minimum unless otherwise stated. Trompeter connectors are designed to exceed all minimum specifications.

## TWINAX/TRIAX CONNECTORS



### 70 Series

Miniature 2, 3, 4 lug, and Push-on (TRB)

**Built to Last Premium Quality**  
**Superior Mechanical Performance**  
**Rugged Physical Properties**  
**Extreme Reliability**

Signals require protection from extraneous noise through non-signal carrying shielding. These interfacing connectors must provide contact surfaces isolated from each other, as well as from the outer shield. Trompeter twinaxial/triaxial connectors are designed with two (2) concentric contacts that are isolated from each other and the shielding connection.

#### Features

- All metallic parts are machined/formed to extremely close tolerances.
- All bodies are made of top quality brass with bright nickel-plated, non-tarnish finish.
- Fully enclosed, heat-treated, beryllium-copper outer conductor spring (not half hard slotted brass) a patented feature!
- Heat-treated, beryllium-copper center socket contact with 50 millionths inch gold plating.

### 370 Series

Miniature Threaded (TRT)

(70 Series shown below)

These concentric twinax/triax connectors are ideal for applications where weight is not a primary concern. They are commonly used in digital data bus, video pair, MIL-STD-1553B (airborne/ground, primary/redundant), base-band circuit and any application for “noise-free guarded” circuits.

#### Features

- Same size as BNC/TNC connectors. Large body versions are available to accommodate larger cables.
- Field serviceable, wrench crimp versions for cables with up to .475" outer diameters.
- Tool crimp versions for quick termination of cables with up to .250" outer diameters.
- 3-lug, 4-lug, and threaded versions provide different levels of mechanical stability and keying.
- Does not require mechanical alignment for mating.
- QPL'd to MIL-C-49142 (see list on page 8).
- Meets MIL-C-49142, 48-hour salt spray requirement.
- Special plating available to satisfy MIL-STD-1344, 500-hour salt spray requirement.
- Push-on versions for test cable applications.
- Fewer pieces to assemble.
- Hermetically sealed versions are available (page 18).



# 70/370 SERIES CONNECTORS QPL'D TO MIL-C-49142

## MIL-C-49142 Qualified Products List

Trompeter has always been a leader in twinax connector design and development. This time we've designed a new connector style to meet the requirements of MIL-C-49142, Category G.

What is Category G? It is the section of the MIL-Spec that requires tool crimping of the TRB (70) series connectors. We are also qualified to category A which is for wrench crimp TRB connectors.

The following is the latest list from Defense Electronic Supply Center (DESC) of qualified Trompeter Electronics' parts. Keep this list handy and make as many copies as needed. QPL'd parts must be ordered by the *MIL-Number*. Many of Trompeter's 70 Series concentric twinax connectors are QPL'd to MIL-C-49142. QPL'd versions are silver plated and can be ordered using the *Government Designation part numbers listed*. Corresponding standard nickel plated connectors can be ordered using the standard part numbers.

MIL-NUMBER	TROMPETER NUMBER
M49142/03-0001	PL75-7
M49142/03-0002	PL75-7
M49142/03-0005	305-0042-1
M49142/03-0007	PL75-9
M49142/03-0008	PL75-47
M49142/03-0009	PL75-60
M49142/03-0011	305-0811-1
M49142/03-0016	PL75MC213
M49142/03-0017	PL75MC-201
M49142/03-0101	PL75Y-7
M49142/03-0102	PL75Y-7
M49142/03-0105	305-0042Y-1
M49142/03-0107	PL75Y-9
M49142/03-0108	PL75Y-47
M49142/03-0109	PL75Y-60
M49142/03-0111	305-0811Y-1
M49142/03-0116	PL75MCY-213
M49142/03-0117	PL75MCY-201
M49142/03-0201	PL75S-7
M49142/03-0202	PL75S-7
M49142/03-0205	305-0042S-1
M49142/03-0207	PL75S-9
M49142/03-0208	PL75S-47
M49142/03-0209	PL75S-60
M49142/03-0211	305-0811S-1
M49142/03-0216	PL75MCS-213
M49142/03-0217	PL75MCS-201
M49142/04-0004	BJ76
M49142/04-0104	BJ76Y
M49142/04-0204	BJ76S
M49142/05-0001	BJ79-7
M49142/05-0002	BJ79-7
M49142/05-0006	305-0042-7
M49142/05-0007	BJ79-9
M49142/05-0008	BJ79-47
M49142/05-0009	BJ79-60
M49142/05-0011	305-0811-3
M49142/05-0016	BJ79MC-213
M49142/05-0017	BJ79MC-201
M49142/05-0101	BJ79Y-7
M49142/05-0102	BJ79Y-7
M49142/05-0106	305-0042Y-7
M49142/05-0107	BJ79Y-9
M49142/05-0108	BJ79Y-47
M49142/05-0109	BJ79Y-60
M49142/05-0111	305-0811Y-3
M49142/05-0116	BJ79MCY-213
M49142/05-0117	BJ79MCY-201
M49142/05-0201	BJ79S-7
M49142/05-0202	BJ79S-7
M49142/05-0206	305-0042S-7
M49142/05-0207	BJ79S-9
M49142/05-0208	BJ79S-47
M49142/05-0209	BJ79S-60
M49142/05-0211	305-0811S-3
M49142/05-0216	BJ79MCS-213
M49142/05-0217	BJ79MCS-201

MIL-NUMBER	TROMPETER NUMBER
M49142/06-0001	CJ70-7
M49142/06-0002	CJ70-7
M49142/06-0006	305-0042-4
M49142/06-0007	CJ70-47
M49142/06-0008	CJ70-9
M49142/06-0009	CJ70-60
M49142/06-0011	305-0811-2
M49142/06-0016	CJ70MC-213
M49142/06-0017	CJ70MC-201
M49142/06-0101	CJ70Y-7
M49142/06-0102	CJ70Y-7
M49142/06-0106	305-0042Y-4
M49142/06-0107	CJ70Y-47
M49142/06-0108	CJ70Y-9
M49142/06-0109	CJ70Y-60
M49142/06-0111	305-0811Y-2
M49142/06-0116	CJ70MCY-213
M49142/06-0117	CJ70MCY-201
M49142/06-0201	CJ70S-7
M49142/06-0202	CJ70S-7
M49142/06-0206	305-0042S-4
M49142/06-0207	CJ70S-47
M49142/06-0208	CJ70S-9
M49142/06-0209	CJ70S-60
M49142/06-0211	305-0811S-2
M49142/06-0216	CJ70MCS-213
M49142/06-0217	CJ70MCS-201
M49142/08-0001	PL375-7
M49142/08-0002	PL375-7
M49142/08-0005	305-0042-9
M49142/08-0006	PL375-47
M49142/08-0008	PL375-60
M49142/08-0010	305-0811-5
M49142/08-0011	305-0486-1
M49142/08-0016	PL375MC-213
M49142/08-0017	PL375MC-201
M49142/09-0001	BJ379-7
M49142/09-0002	BJ379-7
M49142/09-0006	BJ379-47
M49142/09-0007	305-0042-11
M49142/09-0009	BJ379-60
M49142/09-0011	305-0811-7
M49142/09-0012	305-0486-3
M49142/09-0016	BJ379MC-213
M49142/09-0017	BJ379MC-201
M49142/10-0001	BJ376
M49142/11-0001	CJ370-7
M49142/11-0002	CJ370-7
M49142/11-0006	CJ370-47
M49142/11-0007	305-0042-12
M49142/11-0009	CJ370-60
M49142/11-0011	305-0811-6
M49142/11-0012	305-0486-2
M49142/11-0016	CJ370MC-213
M49142/11-0017	CJ370MC-201

## MINIATURE PLUGS & JACKS 70/370 SERIES, TRB/TRT

PL75MC-202 Shown

**CABLE PLUG  
TOOL CRIMP**

3-lug	PL75MC- <sup>△</sup>
2-lug	PL74MC- <sup>△</sup>
4-lug	PL75MCFL- <sup>△</sup>
Threaded	PL375MC- <sup>△</sup>

*For polarizations, call factory*

PL74C-202 Shown

**CABLE PLUG  
TOOL CRIMP**

2-lug	PL74C- <sup>△</sup>
3-lug	PL75C- <sup>△</sup>
4-lug	PL75CFL- <sup>△</sup>
Threaded	PL375C- <sup>△</sup>

*\* Length depends on Cable Group*

PL74-9 Shown

**CABLE PLUG  
WRENCH CRIMP**

2-lug	PL74- <sup>△</sup>
3-lug	PL75- <sup>△</sup>
4-lug	PL75FL- <sup>△</sup>
Threaded	PL375- <sup>△</sup>

PL73C-202 Shown

**CABLE PLUG  
TOOL CRIMP, PUSH-ON**

PL73C-<sup>△</sup>

PL73-9 Shown

**CABLE PLUG  
WRENCH CRIMP, PUSH-ON**

PL73-<sup>△</sup>

*Order Large Body version for cables with jacket dia. greater than .323".*

CJ70-9 Shown

**CABLE JACK  
WRENCH CRIMP**

3-lug	CJ70- <sup>△</sup>
2-lug	CJ70TL- <sup>△</sup>
4-lug	CJ70FL- <sup>△</sup>
Threaded	CJ370- <sup>△</sup>

PLR74C-201 Shown

**RIGHT ANGLE CABLE PLUG  
TOOL CRIMP**

2-lug	PLR74C- <sup>△</sup>
3-lug	PLR75C- <sup>△</sup>
4-lug	PLR75CFL- <sup>△</sup>
Threaded	PLR375C- <sup>△</sup>

*For cable groups 201-223 only. Contact the factory for other cables.*

CJ70C-202 Shown

**CABLE JACK  
TOOL CRIMP**

3-lug	CJ70C- <sup>△</sup>
2-lug	CJ70CTL- <sup>△</sup>
4-lug	CJ70CFL- <sup>△</sup>
Threaded	CJ370C- <sup>△</sup>

ADRMF70 Shown

**RIGHT ANGLE TRB ADAPTER  
TRB MALE TO FEMALE**

3-lug	ADRMF70
2-lug	ADRMF70TL
Threaded	ADRMF370
4-lug	ADRMF70FL

AD78 Shown

**TRB COUPLING  
ADAPTER  
(BARREL CONNECTOR)**

3-lug	AD78
2-lug	AD78TL
4-lug	AD78FL
Threaded	AD378

<sup>△</sup>Refers to the cable group table on pages 82-124.



# MINIATURE BULKHEAD JACKS 70/370 SERIES, TRB/TRT

BJ377 Shown

**BULKHEAD JACK**  
FRONT MOUNT, SOLDER POT

3-lug  
Ground tab  
2-lug  
4-lug  
Threaded

**BJ770**  
**BJ770GL**  
**BJ77TL**  
**BJ77FL**  
**BJ377**

(Hermetically sealed version available, pg.18) Mounting Hole: D4.125

BJ79C Shown

**BULKHEAD CABLE JACK**  
TOOL CRIMP

3-lug  
2-lug  
4-lug  
Threaded

**BJ79C-△**  
**BJ79CTL-△**  
**BJ79CFL-△**  
**BJ379C-△**

For polarizations, contact the factory. Mounting Hole: D3.109

BJ378 Shown

**FEED-THRU BULKHEAD JACK** Threaded

3-lug  
2-lug  
4-lug

**BJ78**  
**BJ78TL**  
**BJ78FL**  
**BJ378**

(Hermetically sealed version available, pg.18) Mounting Hole: D3.187

BJ379-7 Shown

**BULKHEAD CABLE JACK**  
WRENCH CRIMP

3-lug  
2-lug  
4-lug  
Threaded

**BJ79-△**  
**BJ79TL-△**  
**BJ79FL-△**  
**BJ379-△**

Mounting Hole: D3.160

BJ76 Shown

**BULKHEAD JACK**  
REAR MOUNT, SOLDER POT

3-lug  
2-lug  
4-lug  
Threaded

**BJ76**  
**BJ76TL**  
**BJ76FL**  
**BJ376\***

Mounting Holes: D3.240 w/o solder lug/D3.208 w/ solder lug  
(\* Hermetically sealed version avail. pg.13)

BJ75 Shown

**INSULATED BULKHEAD JACK**  
REAR MOUNT, SOLDER POT

3-lug  
2-lug  
4-lug  
Threaded

**BJ75**  
**BJ75TL**  
**BJ75FL**  
**BJ375**

Mounting Hole: D2.140

BJ74-9 Shown

**INSULATED BULKHEAD CABLE JACK**  
WRENCH CRIMP

3-lug  
2-lug  
4-lug  
Threaded

**BJ74-△**  
**BJ74TL-△**  
**BJ74FL-△**  
**BJ374-△**

Mounting Hole: D2.140

BJ74C-202 Shown

**INSULATED BULKHEAD CABLE JACK**  
TOOL CRIMP

3-lug  
2-lug  
4-lug  
Threaded

**BJ74C-△**  
**BJ74CTL-△**  
**BJ74CFL-△**  
**BJ374C-△**

Mounting Hole: D2.140

BJ73 Shown

**INSULATED FEED-THRU JACK**

3-lug  
2-lug  
4-lug  
Threaded

**BJ73**  
**BJ73TL**  
**BJ73FL**  
**BJ373**

Mounting Hole: D2.140

BJ72 Shown

**INSULATED BULKHEAD JACK**  
FRONT MOUNT

3-lug  
2-lug  
4-lug  
Threaded

**BJ72**  
**BJ72TL**  
**BJ72FL**  
**BJ372**

Mounting Hole: D2.140

△ See cable group table on pages 82-124. "D" mounting holes see page 63. For polarizations, contact the factory.

## MINIATURE CIRCUIT BOARD JACKS 70/370 SERIES

CBJ70 Shown

**TWINAX/TRIAX TRB CONCENTRIC CIRCUIT BOARD JACK**

3-lug  
2-lug  
4-lug  
(TRT) Threaded

**CBJ70  
CBJ70TL  
CBJ70FL  
CBJ370**

CBBJ79 Shown

**TWINAX/TRIAX TRB NON-INSULATED CONCENTRIC FEMALE 3-LUG BULKHEAD MOUNT**

3-lug  
2-lug  
4-lug  
Threaded

**CBBJ79  
CBBJ79TL  
CBBJ79FL  
CBBJ379**

Mounting Hole: D3.109

MODEL NO.	LTR CODE	A DIM	B DIM	C DIM	D DIM
CBJR70	-	.24	.050	.090	.0625
CBJR70A	A	.34	.058	.090	.070

**TWINAX/TRIAX TRB RIGHT ANGLE CONCENTRIC CIRCUIT BOARD JACK**

3-lug

**CBJR70  
CBJR70A**

**TWINAX/TRIAX TRB INSULATED CONCENTRIC FEMALE 3-LUG BULKHEAD MOUNT**

3-lug

**CBBJ74**

Mounting Hole: D2.109

MODEL NO.	LTR CODE	A DIM	B DIM	C DIM	D DIM	E DIM
CBBJR79	-	.24	.565	.050	.090	.0625
CBBJR79A	A	.34	.665	.058	.090	.070

**RIGHT ANGLE CIRCUIT BOARD BULKHEAD JACK**

Standard Version

3-lug  
2-lug  
4-lug  
Threaded

**CBBJR79  
CBBJR79TL  
CBBJR79FL  
CBBJR379**

Add "A" for tall versions  
example: **CBBJR79A**

See diagram above

\* 305-0789

Mounting Hole: D3.125

MODEL NO.	LTR CODE	A DIM	B DIM	C DIM	D DIM
CBBJR74	-	.345	.778	.050	.0625
CBBJR74A	A	.445	.878	.058	.070

MAX PANEL THICKNESS .140

**RIGHT ANGLE INSULATED CIRCUIT BOARD BULKHEAD JACK**

Insulated Version

3-lug  
2-lug  
4-lug  
Threaded

**CBBJR74  
CBBJR74TL  
CBBJR74FL  
CBBJR374**

Add "A" for tall versions example: **CBBJR74A**

Mounting Hole: D2.140

"D" mounting holes see page 63.

# TRB SERIES PAD / PARALLELING / T ADAPTER

## TRB SERIES PAD TRB 3-LUG PLUG AND JACK

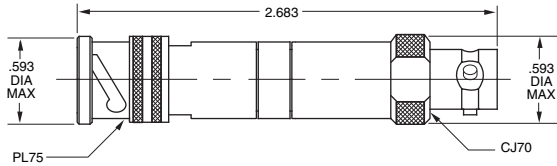

BN73 Shown

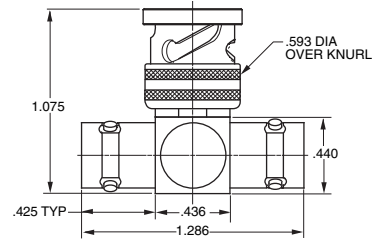

### TRB "T" ADAPTER

3-lug

**BN73**

2-lug

**BN73TL**

4-lug

**BN73FL**

### TRT "T" ADAPTER

Threaded

**BN373**

### PART NUMBER

### CIRCUITRY SCHEMATIC

**TNG2-R**

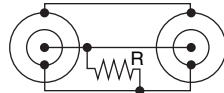

**TNG2A-R1-R2**

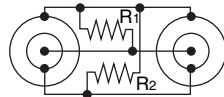

**TNG3-R**

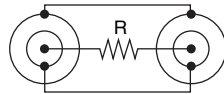

**TNG3A-R1-R2**

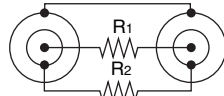

**TNG4-R1-R2-R3**

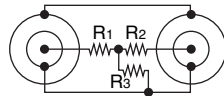

**TNG4A-R1-R2-R3-R4-R5-R6**

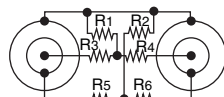

**R-Resistance** (1/2 W 1%)

Substitute resistive value for each "R<sub>N</sub>" unless all values are identical.

## FIXED PARALLELING JACKS

TN2A Shown

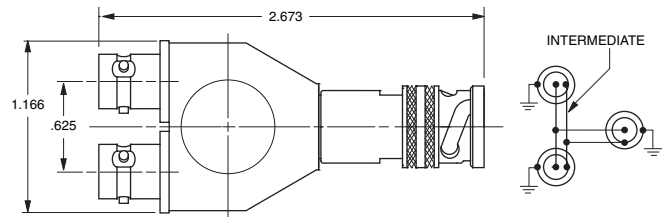

TN2 Shown

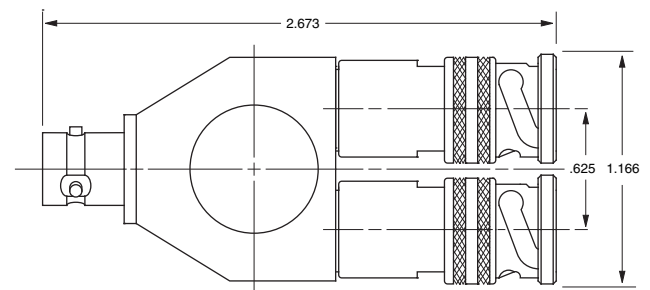

### FIXED PARALLELING JACK

Two Plugs, One Jack

3-lug

**TN2**

2-lug

**TN2TL**

4-lug

**TN2FL**

Threaded

**TN2T**

Two Jacks, One Plug

3-lug

**TN2A**

2-lug

**TN2TLA**

4-lug

**TN2FLA**

Threaded

**TN2TA**

\* Other options available including Random Paralleling.  
Contact the factory for more information.

For Adapters, see pages 68-71. For Terminations, see page 67. For Impedance Matching Adapters, see page 68.

## TWINAX/TRIAX RFI CAPS & TERMINATIONS

### Twinax/Triax Terminators and RFI (Dust Caps)

Trompeter provides Terminations and RFI caps versions of many of our twinax/triax connectors. Resistors are normally 1/8 watt for subminiature connectors and 1/2 watt for miniature and standard size connectors with 1% tolerances for all.



Parts to be capped	Description	Terminator	RFI (Dust Cap)
BJ30/CJ30 Series	TWBNC Jack	TNGT1-(3)-R	RFI25-(3)
BJ70/CJ70 Series	TRB, Jack	TNG1-(3)-R	RFI75-(3)
BJ70FL/CJ70FL	TRB, Jack	TNGFL1-(3)-R	RFI75FL-(3)
BJ70TL/CJ70TL	TRB, Jack	TNGTL1-(3)-R	RFI75TL-(3)
BJ80/CJ80	TRC, Jack	TNGL1-(3)-R	RFI85-(3)
BJ150/CJ150	TRS, Jack	TNGM1-(3)-R	RFI155-(3)
BJ150FL/CJ150FL	TRS, Jack	TNGMFL1-(3)-R	RFI155FL-(3)
BJ375/CJ375	TRT, Jack	TNT1-(3)-R	RFI375-(3)
BJ375/CJ375	TRT, Jack	TNTS1-(3)-R (Safety Holes)	RFI375-(3)
BJ380/CJ380	TRN, Jack	TNTL1-(3)-R	RFI385-(3)
BJ803/CJ803	TRC, 3-lug Jack	TNG3L1-(3)	RFI853-(3)
BJ3150/CJ3150	TTM, Jack	TNTM1-(3)-R	RFI3155-(3)
J72	Twinax Patch Jack	TPT-(3)-R	RFI70-(3)
J72L	Twinax Patch Jack	TPTL-(3)-R	RFI70-(3)
J152	Twinax Submin. Patch Jack	TPTWM-(3)-R	RFI150-(3)
PL30	TWBNC, Plug	TNGBJT1-(3)-R	RFI21-(3)
PL74	TRB, Plug	TNGBJTL1-(3)-R	RFI77TL-(3)
PL75	TRB, Plug	TNGBJ1-(3)-R	RFI77-(3)
PL75FL	TRB, Plug	TNGBJFL1-(3)-R	RFI77FL-(3)
PL80	TRC, Plug	TNGLF1-(3)-R	RFI80-(3)
PL803	TRC, Plug	TNGLF3L1-(3)-R	RFI80(3)
PL380	TRN	TNTLF1-(3)-R	RFI80(3)
PL150	Submin. Patch Plug	TJTWM-(3)-R	-
PL155	TRS, Plug	TNGBJM1-(3)-R (Bulkhead Mount)	RFI157-(3)
PL155	TRS, Plug	TNGMF1-(3)-R	RFI157-(3)
PL155FL	TRS, Plug	TNGBJMFL1-(3) (Bulkhead Mount)	RFI157FL-(3)
PL155FL	TRS, Plug	TNGMFFL1-(3)-R	RFI157FL-(3)
PL3155	TTM, Plug	TNTBJM1-(3)-R (Bulkhead Mount)	RFI3157-(3)
PL3155	TTM, Plug	TNTMF1-(3)-R	RFI3157-(3)
PL350	TCM, Plug		RFI357-(3)
PL375	TRT, Plug	TNTBJ1-(3)-R (Bulkhead Mount)	RFI377-(3)
PL375	TRT, Plug	TNTF1-(3)-R	RFI377-(3)
PL380	TRN, Plug	TNTLF1-(3)-R	RFI380-(3)
PL803	TRC, 3-lug, Plug	TNGLF3L1-(3)-R	RFI803-(3)
For 450/3450 Series:	Concentric Twinax	See pages 24-25	See pages 24-25

Notes: (3) = Chain options, see page 67.  
"R" = Resistance

For Chain Options and Ordering Instructions, see page 67.

# STANDARD TWINAX/TRIAX PATCHING & CABLE ASSEMBLIES

**PATCH JACK** **J70**

**PATCH PLUG** **PL71-7**

**PATCH JACK**  
TRB 3-LUG **J72**

**TERMINATION**  
RFI CAP **TPT-1-R**  
RFI 70-1

For patch jack, no chain  
For other chain options see page 67.

**PATCH JACK**  
SHIELDED **J72D**

Without hood **J72S**

With hood

**PATCH CORD**  
PATCH PLUG TO PATCH PLUG

Twinax	<b>PTW-L-Z</b>
Triax	<b>PTR-L-Z</b>

**CABLE ASSEMBLY**  
TRB 3-LUG PLUG TO PATCH PLUG

Twinax	<b>PTWX-L-Z</b>
Triax	<b>PTRX-L-Z</b>

**CABLE ASSEMBLY**  
TRB 3-LUG PLUGS

Twinax	<b>PTWY-L-Z</b>
Triax	<b>PTRY-L-Z</b>

Bend relief available, call factory.

**PATCH JACK**  
SINGLE ENTRY WITH 20 DB ISOLATED MONITORING JACK  
ENTRY

TRB 3-LUG	<b>PART #</b>
TRT THREADED	<b>J72SM - 1</b>
CABLE (SHOWN)	<b>J72SM - 2</b>
	<b>J72SM - 3</b>

**PARALLEL PATCH CORD**

Twinax	<b>PTWS-L-Z</b>
Triax	<b>PTRS-L-R</b>

△ Refers to Cable Group Table, see pages 82-124. Panels are on pages 60-63.



## STANDARD TWINAX/TRIAX PATCHING

PL71L-9 Shown

### TWINAX PATCH PLUG

PL71L- $\triangle$

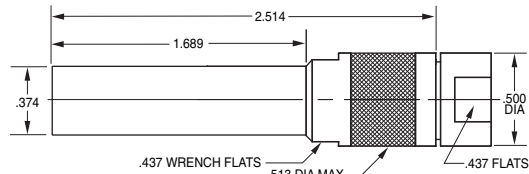

DASH NO.	CONNECTOR TYPE P1 & P2	P3	A DIM	B DIM
-1	BJ20	BJ77	1.166	1.988
-2	PL21	BJ77	1.185	2.177
-3	PL21	BJ77	1.185	2.256
-4	BJ20	BJ377	1.166	1.988
-5	BJ20	PL3155	1.166	2.385
-6	BJ20	PL375	1.166	2.666
-7	UPL21	BJ77	1.186	2.256

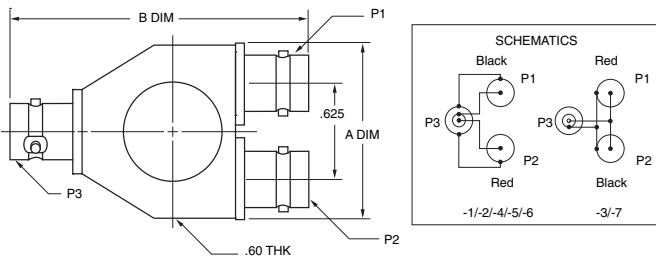

**FIXED PARALLELING JACKS**  
 2 BNC JACKS TO 1 TRB JACK  
 2 BNC PLUGS TO 1 TRB JACK  
 2 BNC PLUGS TO 1 TRB JACK

305-0138-(see chart)



**TWINAX PATCH CORD**  
**TRIAx**

**Twinax** PTWL-L-Z  
**Triax** PTRL-L-Z

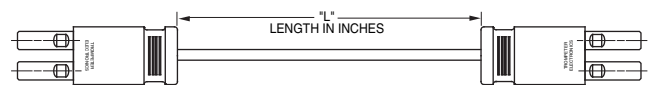

**TWINAX DUAL PATCH CORD**

**DPLTWLS-L-Z**

LPTWL-78 Shown

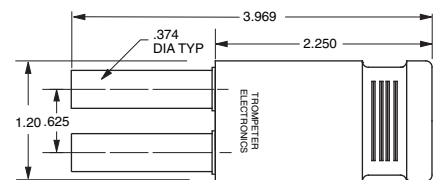

**TWINAX LOOPING PLUG**  
**TRIAx**

**LPTWL-Z**  
**LPTRL-Z**

**TWINAX PATCH JACK J72L**  
**TRB 3-LUG**

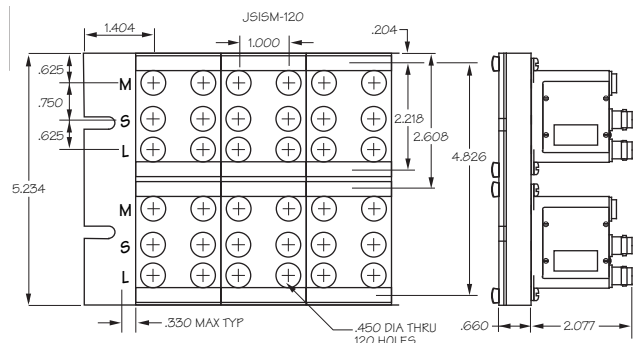
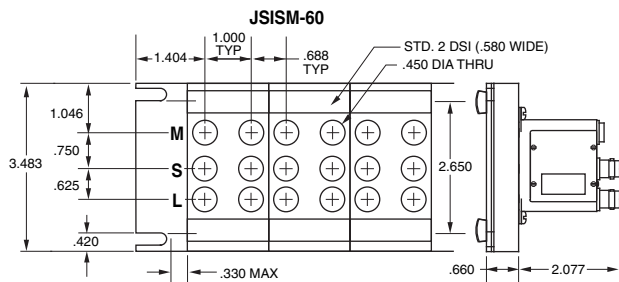
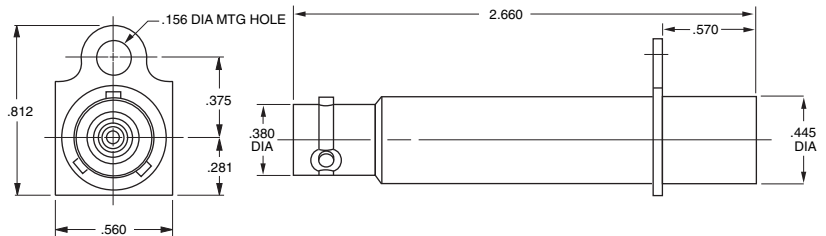

### FRONT-LOADING MODULAR PANELS

FOR USE WITH J74MST-R PATCH JACKS (PG. 57)

PANEL DIMENSIONS	MODULES/ PANELS	JACKS/ MODULE	JACKS/ PANEL
19" X 3.483	10	2	20
19" X 2.34"	10	4	40

**PART NUMBER**  
**155-0830-1 (JSISM-60)**  
**JSISM-120**

R-Resistance (1/2W, 1%), Z-Denotes Cable Impedance.

$\triangle$  Refers to Cable Group Table, see pages 82-124. Standard and Sub-miniature Panels, see pages 60-63.

# STANDARD TWINAX/TRIAX NORMAL-THRU PATCH JACKS

## J74 Series



Trompeter's superior J74 Series of twinax/triax patch jacks provide a normal-thru signal path without the use of looping plugs or patch cords. Same body size as our J24 Series coax dual patch jacks. *It offers a self-wiping, self-normalizing switch with gold plated beryllium copper contacts, which provides positive electrical contact with 30,000 minimum mating cycles.* All metallic parts are machined, formed, or die-casted to extremely close tolerances which provide better intermateability improving EMI/RFI suppression and reduced signal loss. The TRB/TRT patch jack bodies are made of top-quality brass with a bright nickel-plated, non-tarnish finish, which resists tarnishing and the associated reduction of conductivity. Dielectrics are made of machined PTFE for superior dielectric properties and heat resistance. When you want performance and long-life, these patch jacks are what you need.

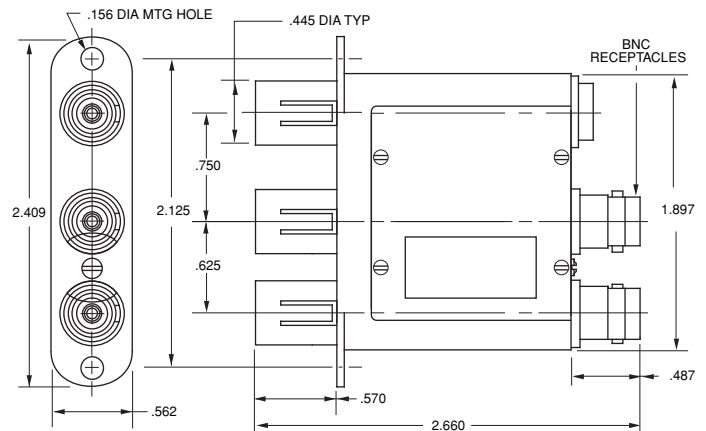

**J74MST-R SCHEMATIC**  
Monitor-Terminated

Plugging into the source side provides a resistive load to the monitored side. Separate 20 dB isolator jack and TRB input jacks for monitoring of the normal-thru signal.

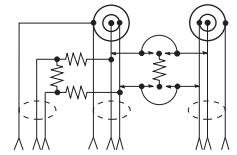

### MONITOR-TERMINATED PATCH JACK PATENT DESIGN

(Use With Front Loading Modular Panels, see page 14.)

### J74MST-R

### NORMAL-THRU PATCH JACK SELF-TERMINATING PATENT DESIGN

### J74T-R

Provides a resistive load to the unused side of the jack. Insertion of a patch plug into the source side automatically terminates the load side. Plugging into the load side automatically terminates the source side.

### DUAL PATCH JACK NORMALLY-TERMINATED PATENT DESIGN

### J74-2T-R

Provides a resistive load.

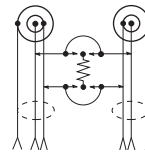
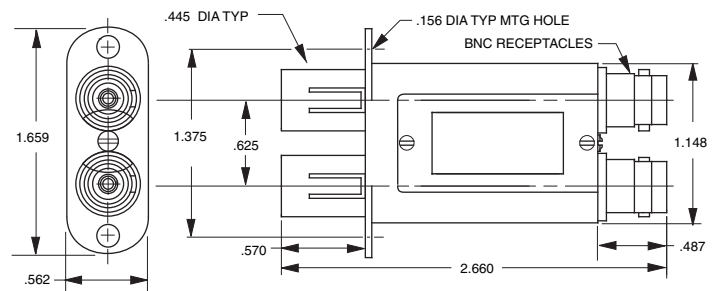

**J74T-R**  
Self-Terminating

Provides a resistive load to the unused side of the jack. Insertion of a patch plug into the source side automatically terminates the load side. Plugging into the load side automatically terminates the source side.

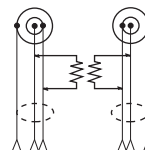

**J74-2T-R**  
Normally-Terminated

Provides a resistive load.

R-Resistance (1/2W, 1%). For standard panels see pages 60-63.

## SUBMINIATURE TWINAX/TRIAX PATCHING

<p>PL150-29 Shown</p> <p><b>SUBMINIATURE PATCH PLUG</b> <span style="float: right;"><b>PL150-</b> </span></p>	<p><b>SUBMINIATURE TWINAX/TRIAX PATCH JACK</b> <i>Smallest twinax/triax patch jack in the world!</i> <span style="float: right;"><b>J158</b></span></p>
<p><b>SUBMINIATURE PATCH JACK</b> Cable Entry Mount on JSIX panels (pages 60-63) <span style="float: right;"><b>J150-</b> </span></p>	<p><b>PATCH CORD</b> SUBMINIATURE PATCH PLUG TO SUBMINIATURE PATCH PLUG Triax 50Ω, 75Ω Twinax 78Ω, 124Ω <span style="float: right;"><b>PTRM-L-Z</b> <b>PTWM-L-Z</b></span></p>
<p><b>SUBMINIATURE PATCH JACK</b> (Shown) TRS 3-lug TRS 4-lug TCM Threaded <span style="float: right;"><b>J152</b> <b>J152FL</b> <b>J3152</b></span></p>	<p><b>CABLE ASSEMBLY</b> SUBMINIATURE PATCH PLUG TO TRS 3-LUG PLUG, 4-lug/threaded versions available Triax 50Ω, 75Ω Twinax 78Ω, 124Ω <span style="float: right;"><b>PTRMX-L-Z</b> <b>PTWMX-L-Z</b></span></p>
<p><b>RFI CAP</b> FOR SUBMINIATURE PATCH JACK, NO CHAIN For other chain options see page 67. <span style="float: right;"><b>RFI 150-1</b></span></p>	<p><b>CABLE ASSEMBLY</b> TRS* 3-LUG PLUG TO TRS* 3-LUG PLUG *4-lug/threaded versions available Triax 50Ω, 75Ω Twinax 78Ω, 124Ω <span style="float: right;"><b>PTRMY-L-Z</b> <b>PTWMY-L-Z</b></span></p>
<p><b>TERMINATION</b> FOR TRS* 3-LUG JACK, NO CHAIN For other chain options see page 67. *4-lug/threaded versions available <span style="float: right;"><b>TNGM1-1-R</b></span></p>	<p><b>CABLE ASSEMBLY</b> METAL JUNCTION, RANDOM PARALLELING TWINAX 78Ω, 124Ω, TRIAX 50Ω &amp; 75Ω TRS* 3-LUG PLUGS *4-lug/threaded versions available <span style="float: right;"><b>TNM3-Z</b></span></p>

Refers to Cable Group Table, see pages 82-124. For JSIX subminiature insulated panels see pages 60-63. Other Terminations and RFI Caps, see page 67.

# TWINAX/TRIAX STANDARD & SUBMINIATURE LOOPING PLUGS

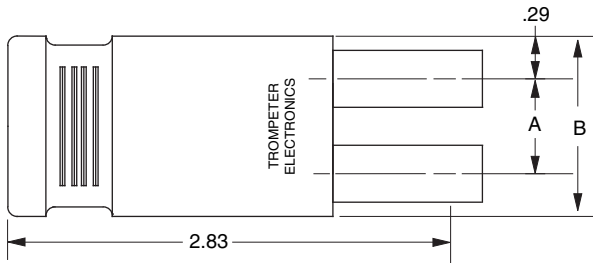

## Standard Twinax/Triax Looping Plugs

<b>Handle:</b> A=.625" B=1.20"	<b>Impedance</b>	<b>Twinax</b>
PLAIN	78Ω	LPTW-78
TEST POINT MONITOR	78Ω	LPTW2TP-78
TRB MONITOR	78Ω	LPTWA-78
PLAIN	124Ω	LPTW-124
TEST POINT MONITOR	124Ω	LPTW2TP-124
TRB MONITOR	124Ω	LPTWA-124

<b>Handle:</b> A=1.00" B=1.57"	<b>Impedance</b>	<b>Twinax</b>
PLAIN	78Ω	LPLTW-78
TEST POINT MONITOR	78Ω	LPLTW2TP-78
TRB MONITOR	78Ω	LPLTWA-78
PLAIN	124Ω	LPLTW-124
TEST POINT MONITOR	124Ω	LPLTW2TP-124
TRB MONITOR	124Ω	LPLTWA-124

<b>Handle:</b> A=.625" B=1.20"	<b>Impedance</b>	<b>Triax</b>
PLAIN	50Ω	LPTR-50
TRB MONITOR	50Ω	LPTRA-50
PLAIN	75Ω	LPTR-75
TRB MONITOR	75Ω	LPTRA-75

<b>Handle:</b> A=1.00" B=1.57"	<b>Impedance</b>	<b>Triax</b>
PLAIN	50Ω	LPLTR-50
TRB MONITOR	50Ω	LPLTRA-50
PLAIN	75Ω	LPLTR-75
TRB MONITOR	75Ω	LPLTRA-75

## Looping Plug Handle Examples

TRS/TRB Monitor

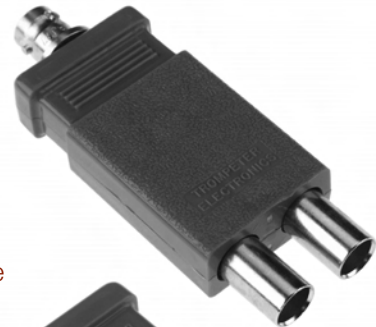

Plain Handle



Test Point Monitor

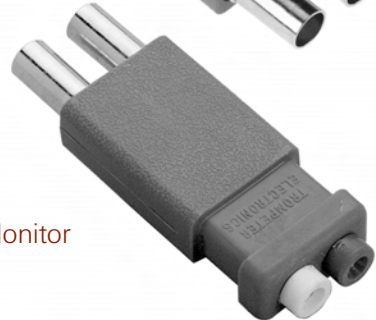

## Subminiature Looping Plugs

<b>Handle</b>	<b>Impedance</b>	<b>Twinax</b>
BLUE	78Ω	LPTWM-78
BLUE TRS JACKS	78Ω	LPTWMA-78
BLUE TEST POINT	78Ω	LPTWM2TP-78

BLUE	124Ω	LPTWM-124
BLUE TRS JACKS	124Ω	LPTWMA-124
BLUE TEST POINT	124Ω	LPTWM2TP-124

<b>Handle</b>	<b>Impedance</b>	<b>Triax</b>
YELLOW	50Ω	LPTRM-50
YELLOW	75Ω	LPTRM-75

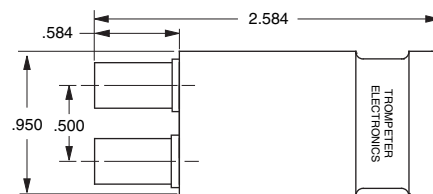

LPTWM-Z SHOWN  
Z = IMPEDANCE

## HERMETICALLY SEALED CONNECTORS

### Concentric Twinax/Triax

Hermetic seals prevent leakage through the bulkhead from inside of the connector. Trompeter's miniature size hermetically sealed connectors include the feed-through BJ78HS, the front mounted BJ77HS, the rear mounted BJ79HS and the newly designed threaded BJ379HS. In the subminiature size we offer the front mounted BJ157HS and BJ157FLHS (four lug version). The BJ3150HS and BJ3150SHS offer a threaded rear mount version with a safety wire option. These connectors are designed for bulkhead mounting in vacuum chambers, or where toxic and other gases are present. These connectors have leakage rates of  $1 \times 10^{-8}$  atm cc/second. The 150 Series have leakage rates of  $1 \times 10^{-6}$  atm cc/second.

#### Features

- Standard TRB/MIL-C-49142
- Glass to Metal Seals
- Sustains Extreme Temperature Ranges
- Standard Brass Body
- Gold Plated Contacts

#### Benefits

- The Most Mechanical and Environmentally Reliable Method
- Wide Range of Application Usage
- More Cost Effective than Stainless Steel
- Reliable Connections



They all meet MIL-C-49142 specifications. Standard non-hermetic connector types such as the BJ78 could leak between the contacts and dielectrics. Hermetically sealed connectors can be used in commercial, military, and industrial applications where toxic gas maybe present. Hermetic connectors are highly beneficial in reactors, gas/petro plants, oil drilling sites, liquid test and measurement, and space applications. They are reliable under the most severe atmospheric conditions.

**HERMETICALLY SEALED BULKHEAD JACK FRONT MOUNT BJ77HS**  
Mounting Hole: D4.125

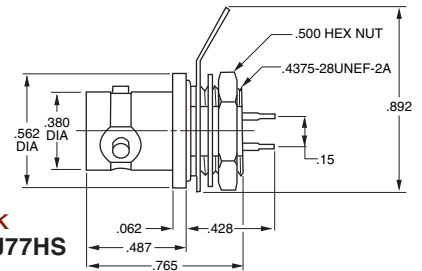

**HERMETICALLY SEALED BULKHEAD JACK 3-lug BJ157HS 4-lug BJ157FLHS**  
Mounting Hole: D6.187

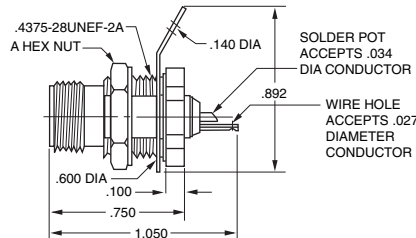
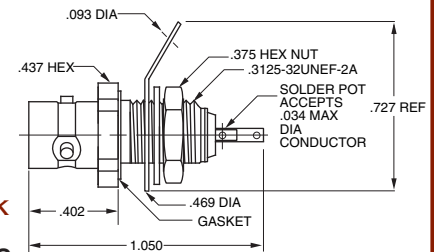

**HERMETICALLY SEALED SUBMINIATURE TWINAX/TRIAX REAR MOUNT BJ3150HS A = .500 SOLDER POT BULKHEAD BJ3150SHS A = .562**  
Mounting Hole: D4.200

BJ78HS Shown

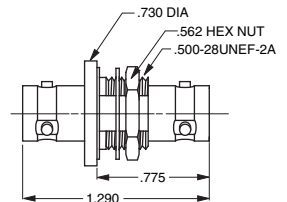

**HERMETICALLY SEALED MINIATURE TWINAX/TRIAX FEED-THRU BULKHEAD MOUNT BJ78HS BJ378HS (Threaded Version Not Shown)**  
Mounting Hole: D3.187  
**INSULATED VERSION BJ73HS (Not Shown)**  
Mounting Hole: D2.187

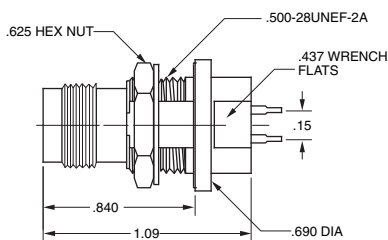

**HERMETICALLY SEALED MINIATURE TWINAX/TRIAX TRT/THEADED BJ376HS**  
Mounting Hole: D3.160

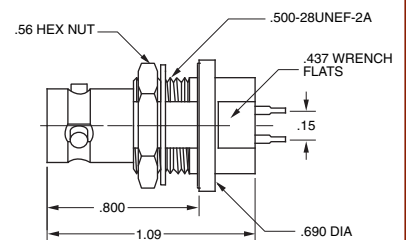

**HERMETICALLY SEALED MINIATURE TWINAX/TRIAX REAR MOUNT, BULKHEAD MOUNT BJ79HS**  
Mounting Hole: D3.160

Note: Only a select few of our hermetically sealed connectors are shown here. Contact the factory for more information.

"D" mounting holes see page 63.



# TWINAX/TRIAX 150 SERIES INTRO

## SIZE 8 MATING CONTACTS

### 150 Series

Miniature 2,3, 4-lug, & Push-on (TRS)

### 3150 Series

Miniature Threaded (TTM)

150/3150 Series are concentric twinax/triax connectors for high density and weight reduction applications. They are commonly used in digital data bus, video pair, MIL-STD-1553B (primary/redundant), baseband circuit and in any application for “noise-free guarded” circuits. TRS/TTM push-on connectors are designed for blind mate rack and panel applications. The male plug mates with any TRS/TTM jack and are ideally suited for test cable applications.



### Features

- Same size as TPS/TCM connectors.
- Solderable Wrench Crimp versions for cables with up to .215" outer diameter.
- Tool Crimp versions for quick termination of cables with up to .250" outer diameter.
- 3-lug, 4-lug, and threaded versions provide different levels of mechanical stability and keying.
- Does not require mechanical alignment for mating.
- Meets MIL-C-49142, 48-hour salt spray requirement.
- Special plating available to satisfy MIL-STD-1344 500-hour salt spray requirement.
- Push-on versions for test cable applications.
- Fewer pieces to assemble.
- Hermetically sealed versions available (see page 18).

## Mating Twinax Size 8 Contacts

for Digital Data Bus Multi-pin Connectors

This pair of **scoop-proof** concentric contacts fits the Size 8 cavity of MIL-C-38999 series 1, 3, & 4 and MIL-STD-1760 “External Stores” type connectors.

### Features

- Fits MIL-C-17/176-00002 and other twinax/triax cables
- Heat treated **beryllium copper** spring members
- Gold plated, Full Crimp contacts

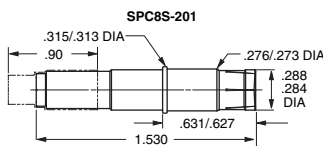

TROMPETER PART NO.  
SOCKET **SPC8S-201**

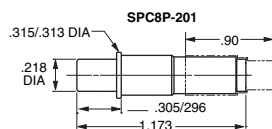

TROMPETER PART NO.  
PIN **SPC8P-201**

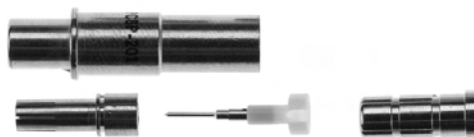

## SUBMINIATURE JACKS & PLUGS 150/3150 SERIES TRS/TTM



### Sub-miniature Jacks & Plugs

Sub-miniature concentric twinax/triax connectors increase packing density up to 246%. They are designed for high density applications where digital, video pair or baseband noise-free guarded circuits are required. The 3-lug, 4-lug, and threaded versions improve mechanical stability and provide “error-free” redundant data bus capabilities. The wrench crimp version accommodates cables with other jacket diameters up to .215" and the tool crimp versions up to .250".

<p>PL155-29 Shown</p> <p><b>CABLE PLUG WRENCH CRIMP</b></p> <p>3-lug 4-lug Threaded</p> <p><b>PL155-</b> <b>PL155FL-</b> <b>PL3155-</b></p>	<p>BJ159-29 Shown</p> <p><b>BULKHEAD JACK REAR MOUNT, WRENCH CRIMP</b></p> <p>3-lug 4-lug Threaded</p> <p><b>BJ159-</b> <b>BJ159FL-</b> <b>BJ3159-</b></p> <p>Mounting Hole: D4.125</p>
<p>PL155AC-207 Shown</p> <p><b>CABLE PLUG TOOL CRIMP</b></p> <p>3-lug 4-lug Threaded</p> <p><b>PL155AC-</b> <b>PL155ACFL-</b> <b>PL3155AC-</b></p>	<p>BJ159AC Shown</p> <p><b>BULKHEAD JACK REAR MOUNT, TOOL CRIMP</b></p> <p>3-lug 4-lug Threaded</p> <p><b>BJ159AC-</b> <b>BJ159ACFL-</b> <b>BJ3159AC-</b></p> <p>Mounting Hole: D4.125</p>
<p>PLR3155AC-201 Shown</p> <p><b>RIGHT ANGLE CABLE PLUG TOOL CRIMP</b></p> <p>3-lug 4-lug Threaded</p> <p><b>PLR155AC-</b> <b>PLR155ACFL-</b> <b>PLR3155AC-</b></p>	<p>CJ150-29 Shown</p> <p><b>CABLE JACK WRENCH CRIMP</b></p> <p>3-lug 4-lug Threaded</p> <p><b>CJ150-</b> <b>CJ150FL-</b> <b>CJ3150-</b></p>
<p>PLR3155AC-201 Shown</p> <p><b>CABLE JACK TOOL CRIMP</b></p> <p>3-lug 4-lug Threaded</p> <p><b>CJ150AC-</b> <b>CJ150ACFL-</b> <b>CJ3150AC-</b></p>	<p>CJ150AC-207 Shown</p> <p><b>CABLE JACK TOOL CRIMP</b></p> <p>3-lug 4-lug Threaded</p> <p><b>CJ150AC-</b> <b>CJ150ACFL-</b> <b>CJ3150AC-</b></p>

Refers to Cable Group Table see pages 82-124. "D" mounting holes see page 63.

# SUBMINIATURE BULKHEAD JACKS 150/3150 SERIES TRS/TTM

<p>BJ157 Shown</p> <p><b>BULKHEAD JACK</b> FRONT MOUNT, SOLDER POT</p> <p>3-lug <b>BJ157</b> 4-lug <b>BJ157FL</b> Thru <b>BJ3157</b></p> <p>(Hermetically sealed version available, pg.18) Mounting Hole: D6.187</p>	<p>BJ158 Shown</p> <p><b>FEED-THROUGH JACK</b></p> <p>3-lug <b>BJ158</b> 4-lug <b>BJ158FL</b> Thru <b>BJ3158</b></p> <p>Mounting Hole: D5.190/D4.190 (Thru)</p>															
<p><b>BULKHEAD JACKS</b> FLANGE MOUNT, SOLDER POT</p> <p>3-lug <b>BJ157F-2</b> 4-lug <b>BJ157FFL-2</b> Thru <b>BJ3157F-2</b></p> <p><b>HOLE CONFIGURATION:</b></p> <table border="1"> <thead> <tr> <th>A Dim = .425</th> <th># of holes/ Type-Dimension</th> <th></th> </tr> </thead> <tbody> <tr> <td></td> <td>2/Clear- .103" diameter</td> <td>- 2C(S)</td> </tr> <tr> <td></td> <td>2/Thru-.099-56UNF-2B</td> <td>- 2T(S)</td> </tr> <tr> <td>B Dim = .687</td> <td>4/Clear- .103" diameter</td> <td>- 4C(S)</td> </tr> <tr> <td></td> <td>4/Thru-.099-56UNF-2B</td> <td>- 4T(S)</td> </tr> </tbody> </table> <p>(S) = Comes with Stainless Steel Phillips #3-56 Pan Head Screws Maximum Panel Thickness .187</p>	A Dim = .425	# of holes/ Type-Dimension			2/Clear- .103" diameter	- 2C(S)		2/Thru-.099-56UNF-2B	- 2T(S)	B Dim = .687	4/Clear- .103" diameter	- 4C(S)		4/Thru-.099-56UNF-2B	- 4T(S)	<p>BJ155 Shown</p> <p><b>INSULATED BULKHEAD JACK</b> REAR MOUNT, SOLDER POT</p> <p>3-lug <b>BJ155</b> 4-lug <b>BJ155FL</b> Thru <b>BJ3155</b></p> <p>Mounting Hole: D9.148</p>
A Dim = .425	# of holes/ Type-Dimension															
	2/Clear- .103" diameter	- 2C(S)														
	2/Thru-.099-56UNF-2B	- 2T(S)														
B Dim = .687	4/Clear- .103" diameter	- 4C(S)														
	4/Thru-.099-56UNF-2B	- 4T(S)														
<p>BJ152 Shown</p> <p><b>INSULATED BULKHEAD JACK</b> FRONT MOUNT, SOLDER POT</p> <p>3-lug <b>BJ152</b> 4-lug <b>BJ152FL</b> Thru <b>BJ3152</b></p> <p>Mounting Hole: D9.208</p>	<p>BJ154-29 Shown</p> <p><b>INSULATED BULKHEAD JACK</b> REAR MOUNT, WRENCH CRIMP</p> <p>3-lug <b>BJ154-29</b> 4-lug <b>BJ154FL-29</b> Thru <b>BJ3154-29</b></p> <p>Mounting Hole: D9.116</p>															
<p>BJ154AC-207 Shown</p> <p><b>INSULATED BULKHEAD JACK</b> REAR MOUNT, TOOL CRIMP</p> <p>3-lug <b>BJ154AC-207</b> 4-lug <b>BJ154ACFL-207</b> Thru <b>BJ3154AC-207</b></p> <p>Mounting Hole: D9.116</p>	<p>BJ150 Shown</p> <p><b>BULKHEAD JACK</b> REAR MOUNT, SOLDER POT</p> <p>3-lug <b>BJ150</b> 4-lug <b>BJ150FL</b> Thru <b>BJ3150</b></p> <p>Mounting Hole: D4.250</p>															
<p>BJ153 Shown</p> <p><b>INSULATED FEED-THROUGH JACK</b></p> <p>3-lug <b>BJ153</b> 4-lug <b>BJ153FL</b> Thru <b>BJ3153</b></p> <p>Mounting Hole: D9.116</p>																

△ Refers to the cable group table see pages 82-124. △ Replace with item from related table (same page). "D" mounting holes see page 63.

## SUBMINIATURE 150/3150 SERIES

**BULKHEAD MOUNT JACK WITH PC TAILS**  
**305-1222**  
 Mounting Hole: D4.125

**BULKHEAD PUSH-ON PLUG FRONT MOUNT, SOLDER POT**  
**PL151**  
 Mounting Hole: C1.088

**CIRCUIT BOARD JACK**  
**CBJ157**  
 3-lug  
 4-lug  
 Threaded  
**CBJ157FL**  
**CBJ3157**  
 Max Board Thickness .125

**BULKHEAD PUSH-ON JACK FRONT MOUNT, SOLDER POT**  
**BJ151**  
 Mounting Hole: C1.088

**RIGHT ANGLE CIRCUIT BOARD JACK**  
**CBJR157**  
 3-lug  
 4-lug  
 Threaded  
**CBJR157FL**  
**CBJR3157**

**PUSH-ON CABLE PLUG WRENCH CRIMP**  
**PL153-1**

**'T' ADAPTER**  
**BN153**  
 3-lug  
 4-lug  
 Threaded  
**BN153FL**  
**BN3153**

**TWINAX/TRIAX TRS SUBMINIATURE RIGHT ANGLE BULKHEAD REAR MOUNT 3-LUG**  
**CBBJR159**  
 Max Panel Thickness: .125 D-Hole: D4

**TRS/TTM COUPLING ADAPTER (BARREL CONNECTOR)**  
**AD158**  
 3-lug  
 4-lug  
 Threaded  
**AD158FL**  
**AD3158**

**PUSH-ON CABLE PLUG TOOL CRIMP**  
**PL153AC-1**

△ Refers to Cable Group Table see pages 82-124. "D" mounting holes see page 63.

# TWINAX/TRIAX SERIES INTRODUCTIONS

## 450 Series

Subminiature Twinax 3-lug & 4-lug

## 3450 Series

Subminiature Twinax Threaded

Concentric connectors designed for MIL-STD-1553B airborne digital databus weight reduction applications.

### Features

- 3-lug, 4-lug & threaded versions.
- Field installation full crimp design. No soldering required.
- Fully inspectable assembly process (no blind or questionable solder connections)
- Total of ten (10) polarized & keyed combinations.
- Three different keyings for 3-lug versions.
- Two interchangeable pin & socket arrangements.
- Fewer pieces to assemble.
- Meets MIL-C-49142, 48-hour salt spray requirement.
- Standard plating to satisfy MIL-STD-1344, 500-hour salt-spray requirement.
- Weatherproof designs utilize sealing gaskets and heat shrink tubing.
- Fits MIL-C-17/176-00002 & other twinax/triax cables.
- Compatible with Raychem designs but utilizing military.



## 80 Series

Standard 2-lug & 3-lug (TRC)

## 380 Series

Standard Threaded (TRN)

Used in digital data bus, video pair, MIL-STD-1553B (primary/redundant data bus), MIL-STD-1397 (shipboard data bus), baseband circuit and any application for noise-free guarded circuits.

### Features

- Standard “C” sized concentric connectors.
- Used with larger twinax/triax cables with outer diameters of .250"-.615".
- Does not require mechanical alignment for mating.



## 30 Series

Miniature 2-Pin Polarized, 2-lug (TWBNC)

## 330 Series

Miniature 2-Pin Polarized, Threaded (TWTNC)

Used in digital data bus, video pair, MIL-STD 1553B (airborne/ground primary/redundant), baseband circuit and any application for “noise-free guarded” circuits. They are not recommended for new designs. MIL-STD-1553B permits designer discretion for use of concentric designs in lieu of the two-pin connector.

### Features

- Same size as BNC/TNC connectors
- Fully enclosed beryllium copper spring fingers
- Stepped Dielectric





## CONCENTRIC TWINAX 450 SERIES

### Concentric Twinax 450 Series

3-lug & 4-lug Keyings

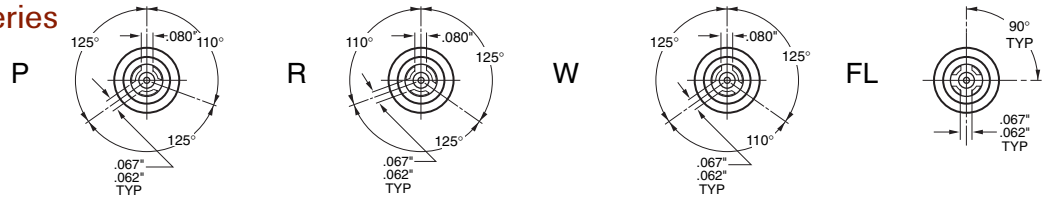

The 450 Series was designed for airborne digital data bus applications utilizing the MIL-STD-1553B data bus. The 450 Series will fit most twinax cables. Connectors are available in five different coupling configurations which include 3-lug versions

with three (3) separate keyings, a 4-lug, and a threaded version with safety wire holes.

Diagrams shown above are for plugs. Refer to page 25 for photo of intermediate contacts.

BULKHEAD JACK REAR MOUNT, SOLDER POT		COUPLING TYPE	KEY CODE	INTERMEDIATE CONTACT PIN	SOCKET
<p>Mounting Holes: DD8.130 DD8.125 (Threaded)</p>	3-lug	P	BJ450PP	BJ450PS	
	3-lug	R	BJ450RP	BJ450RS	
	3-lug	W	BJ450WP	BJ450WS	
	4-lug	FL	BJ450FLP	BJ450FLS	
	Threaded	-	BJ3450P	BJ3450S	
BULKHEAD JACK FRONT MOUNT, SOLDER POT		COUPLING TYPE	KEY CODE	INTERMEDIATE CONTACT PIN	SOCKET
<p>Mounting Holes: DD8.250 DD8.125 (Threaded)</p> <p>BJ457FLP-1 SHOWN</p>	3-lug	P	BJ457PP	BJ457PS	
	3-lug	R	BJ457RP	BJ457RS	
	3-lug	W	BJ457WP	BJ457WS	
	4-lug	FL	BJ457FLP	BJ457FLS	
	Threaded	-	BJ3457P	BJ3457S	
RIGHT ANGLE CABLE PLUG ALL CRIMP		COUPLING TYPE	KEY CODE	INTERMEDIATE CONTACT PIN	SOCKET
<p>PLR455ACPP-201</p>	3-lug	P	PLR455ACPP- $\triangle$	PLR455ACPS- $\triangle$	
	3-lug	R	PLR455ACRP- $\triangle$	PLR455ACRS- $\triangle$	
	3-lug	W	PLR455ACWP- $\triangle$	PLR455ACWS- $\triangle$	
	4-lug	FL	PLR455ACFLP- $\triangle$	PLR455ACFLS- $\triangle$	
	Threaded	-	PLR3455ACP- $\triangle$	PLR3455ACS- $\triangle$	
RFI JACK CAPS & BULKHEAD JACK TERMINATIONS FOR USE WITH 450 SERIES PLUGS REAR MOUNT		COUPLING TYPE	RFI CAPS	TERMINATIONS INTERMEDIATE CONTACT PIN	SOCKET
3-lug	RFI457- $\triangle$	TBJ451P- $\triangle$ -R	TBJ451S- $\triangle$ -R		
3-lug	RFI457- $\triangle$	TBJ451P- $\triangle$ -R	TBJ451S- $\triangle$ -R		
3-lug	RFI457- $\triangle$	TBJ451P- $\triangle$ -R	TBJ451S- $\triangle$ -R		
4-lug	RFI457FL- $\triangle$	TBJ451FLP- $\triangle$ -R	TBJ451FLS- $\triangle$ -R		
Threaded	RFI3457- $\triangle$	TBJ3451P- $\triangle$ -R	TBJ3451S- $\triangle$ -R		

$\triangle$  Refers to Cable Group Table see pages 82-124.  $\triangle$  For Chain options, see page 67. "D" mounting holes see page 63.

# CONCENTRIC TWINAX 450 SERIES

## 450 Series

Intermediate Contact Assemblies

PIN/SOCKET

PS450AC- 













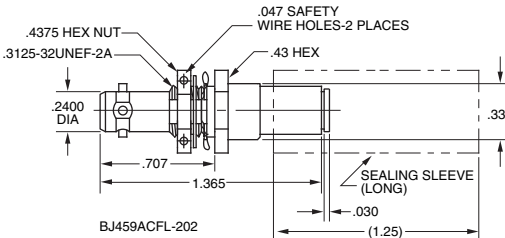















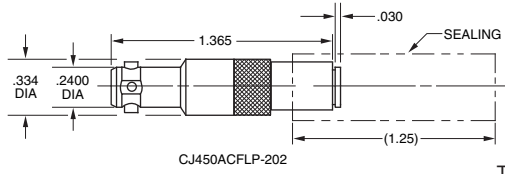















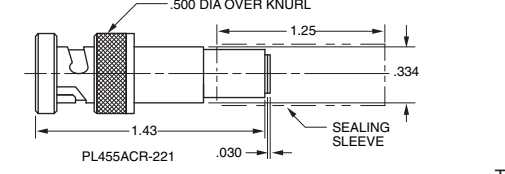



















SOCKET/PIN

SP450AC- 



The 450 Series includes cable jacks and plugs with interchangeable contact assemblies. The contact and body assemblies may be ordered separately (see the facing page). Cable connectors accept cables with a maximum outer diameter of .180" and conductors to .025".

Contact the factory for exact specifications. For Trompeter connectors which meet outgassing requirements, contact our technical support staff for more information. Compatible with Raychem DK-621 Series. *Refer to page 24 for Keyings.*

BULKHEAD CABLE JACK REAR MOUNT, ALL CRIMP		COUPLING TYPE	KEY CODE	BODY ASSEMBLY ONLY	ASSEMBLY INTERMEDIATE CONTACT						
					PIN	SOCKET					
	3-lug	P	BJ459ACP-		BJ459ACPP-		BJ459ACPS-				
	3-lug	R	BJ459ACR-		BJ459ACRP-		BJ459ACRS-				
	3-lug	W	BJ459ACW-		BJ459ACWP-		BJ459ACWS-				
	4-lug	FL	BJ459ACFL-		BJ459ACFLP-		BJ459ACFLS-				
	Threaded	-	BJ3459AC-		BJ3459ACP-		BJ3459ACS-				
CABLE JACK ALL CRIMP		COUPLING TYPE	KEY CODE	BODY ASSEMBLY ONLY	ASSEMBLY INTERMEDIATE CONTACT						
					PIN	SOCKET					
	3-lug	P	CJ450ACP-		CJ450ACPP-		CJ450ACPS-				
	3-lug	R	CJ450ACR-		CJ450ACRP-		CJ450ACRS-				
	3-lug	W	CJ450ACW-		CJ450ACWP-		CJ450ACWS-				
	4-lug	FL	CJ450ACFL-		CJ450ACFLP-		CJ450ACFLS-				
	Threaded	-	CJ3450AC-		CJ3450ACP-		CJ3450ACS-				
CABLE PLUG ALL CRIMP		COUPLING TYPE	KEY CODE	BODY ASSEMBLY ONLY	ASSEMBLY INTERMEDIATE CONTACT						
					PIN	SOCKET					
	3-lug	P	PL455ACP-		PL455ACPP-		PL455ACPS-				
	3-lug	R	PL455ACR-		PL455ACRP-		PL455ACRS-				
	3-lug	W	PL455ACW-		PL455ACWP-		PL455ACWS-				
	4-lug	FL	PL455ACFL-		PL455ACFLP-		PL455ACFLS-				
	Threaded	-	PL3455AC-		PL3455ACP-		PL3455ACS-				
RFI PLUG CAPS & TERMINATIONS PLUGS FOR USE WITH 450 SERIES JACKS		COUPLING TYPE		RFI CAPS		TERMINATIONS INTERMEDIATE CONTACT					
						PIN TO MATE WITH SOCKETS					
						SOCKETS TO MATE WITH PINS					
	3-lug			RFI455-		TNG451P-		-R	TNG451S-		-R
	3-lug			RFI455-		TNG451P-		-R	TNG451S-		-R
	3-lug			RFI455-		TNG451P-		-R	TNG451S-		-R
	4-lug			RFI455FL-		TNG451FLP-		-R	TNG451FLS-		-R
	Threaded			RFI3455-		TNG3451P-		-R	TNG3451S-		-R

 Refers to Cable Group Table see pages 82-124.  Chain options see page 67. "D" mounting holes see page 63.

## STANDARD TWINAX/TRIAX THREADED 80/380 SERIES, TRC/TRN

PL80-9 Shown

**CABLE PLUG**

2-lug  
3-lug  
Threaded

**PL80-<sup>△</sup>**  
**PL803-<sup>△</sup>**  
**PL380-<sup>△</sup>**

*Larger bodies available to accommodate cable sizes, contact the factory.*

CJ80-7 Shown

**CABLE JACK**  
**WRENCH CRIMP**

2-lug  
3-lug  
Threaded

**CJ80-<sup>△</sup>**  
**CJ803-<sup>△</sup>**  
**CJ380-<sup>△</sup>**

Top Drawing: BJ89F-10 Shown

**BULKHEAD CABLE JACKS**  
**WRENCH CRIMP, FLANGE MOUNT**

2-lug  
3-lug  
Threaded

**BJ89F-<sup>△</sup>**  
**BJ893F-<sup>△</sup>**  
**BJ389F-<sup>△</sup>**

**WRENCH CRIMP, D HOLE MOUNT**

2-lug  
3-lug  
Threaded

**BJ89-<sup>△</sup>**  
**BJ893-<sup>△</sup>**  
**BJ389-<sup>△</sup>**

Mounting Holes: DD6.250 / D11.250 - Cable Groups: -14A, -16, -61, -62

Bottom Drawing: BJ89-10 Shown

BJ80 Shown

**BULKHEAD JACK**  
**SOLDER POT**

2-lug  
3-lug  
Threaded

**BJ80**  
**BJ803**  
**BJ380**

Mounting Hole: D1.156

CBBJ82 SHOWN

**CIRCUIT BOARD**  
**BULKHEAD JACK**

2-lug  
3-lug  
Threaded

**CBBJ82**  
**CBBJ823**  
**CBBJ382**

Maximum Panel Thickness: .190 Mounting Hole: C6.250

BJ83 Shown

**INSULATED**  
**FEED-THRU JACK**

2-lug  
3-lug  
Threaded

**BJ83**  
**BJ833**  
**BJ383**

Mounting Hole: D1.350

BN83-1 Shown

**TRC "T" ADAPTER**

2-lug  
3-lug  
Threaded

**BN83-1**  
**BN833-1**  
**BN383-1**

*For other chain options see page 67.*

BJ88 Shown

**FEED-THRU JACK**

2-lug  
3-lug  
Threaded

**BJ88**  
**BJ883**  
**BJ388**

Mounting Hole: D1.343

<sup>△</sup> Refers to Cable Group Table see pages 82-124. "D" mounting holes see page 63.

# TWO-PIN POLARIZED 30/330 SERIES TWBNC/TWTNC

Mil-C-3655 Interface

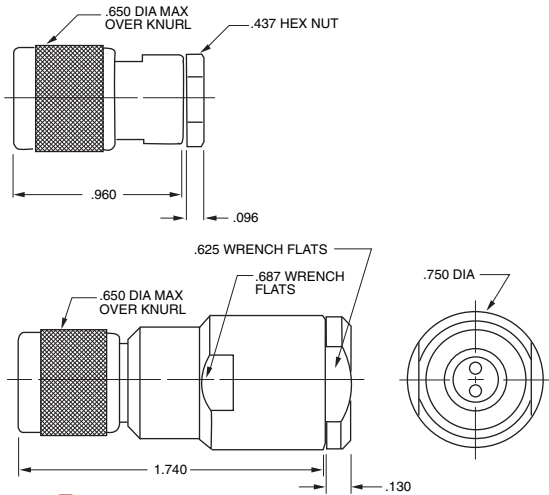

**CABLE PLUG**  
TWTNC POSITIVE ALIGNING  
TWO-PIN POLARIZED

**PLPA330**

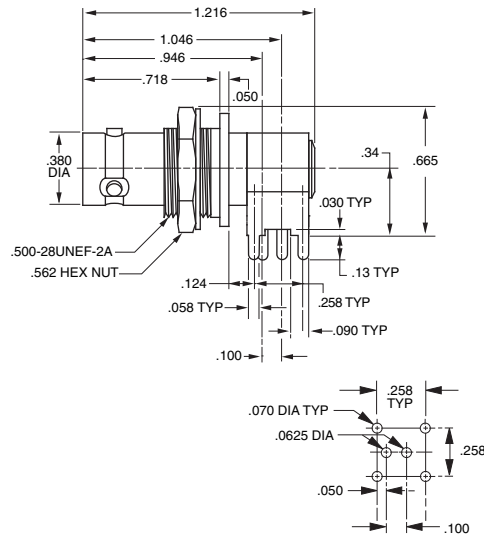

**CIRCUIT BOARD BULKHEAD JACK**  
RIGHT ANGLE-TWO-PIN  
POLARIZED TWINAX (TWBNC)  
Mounting Hole: D3.125

**CBBJR39A**

PL30 Shown

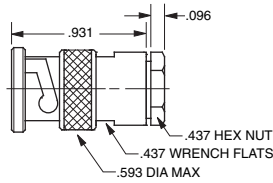

**CABLE PLUG**  
WRENCH CRIMP, TWO-PIN POLARIZED

2-lug  
Threaded

**PL30-**  
**PL330-**

BJ30 Shown

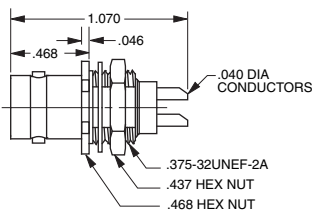

**BULKHEAD JACK**  
FRONT MOUNT, SOLDER POT  
TWO-PIN POLARIZED

2-lug  
Threaded

**BJ30**  
**BJ330**

Mounting Hole: D5.130

BJ31 Shown

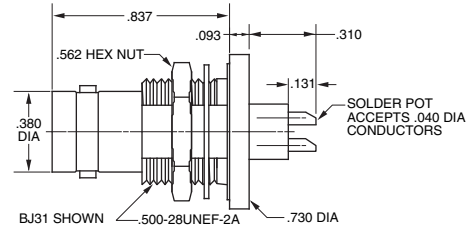

**BULKHEAD JACK**  
REAR MOUNT, SOLDER POT  
TWO-PIN POLARIZED

2-lug  
Threaded

**BJ31**  
**BJ331**

Mounting Hole: D3.280

BJ38 Shown

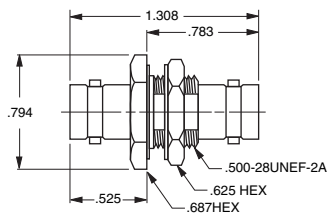

**FEED-THROUGH JACK**  
TWO-PIN POLARIZED

2-lug  
Threaded

**BJ38**  
**BJ338**

Mounting Hole: D3.160

BJ39 Shown

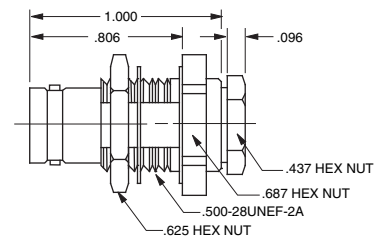

**BULKHEAD CABLE JACK**  
REAR MOUNT, WRENCH CRIMP  
TWO-PIN POLARIZED

2-lug  
Threaded

**BJ39-**  
**BJ339-**

Mounting Hole: D3.218

△ Refers to Cable Group Table, see pages 82-124. "D" mounting holes are on page 63. Note: Only 30/330 Series have two-pin polarizations.

## BNC Coax Connector Introduction

### Trompeter's BNC Coax Tool Crimp Connector

19 reasons why our BNC connectors outperform the competition every time!

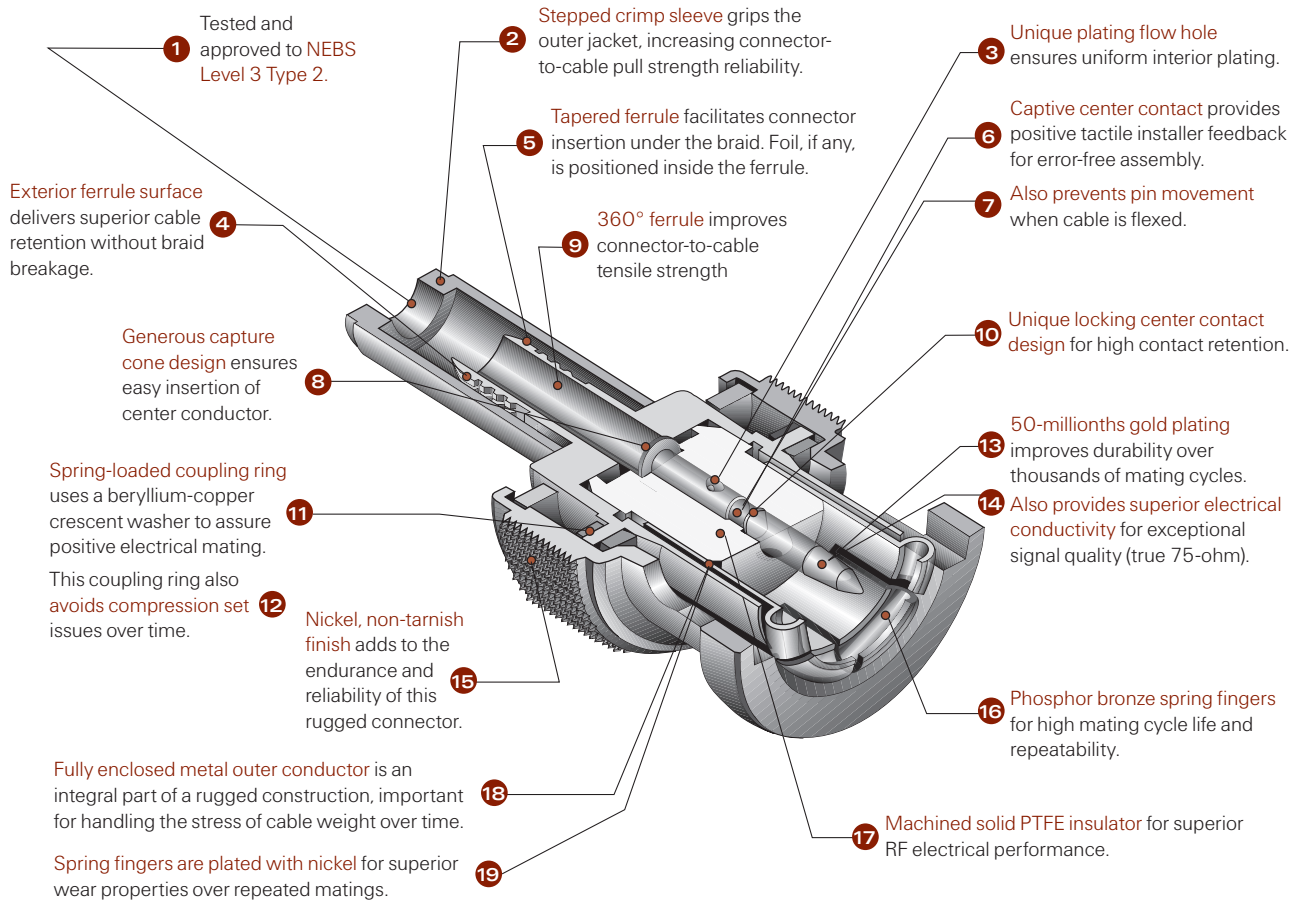

### BNC Coax Wrench Crimp Connector

#### Wrench Crimp Features

- 3-piece construction
- Captive center contact pin in cone assembly
- Spring-loaded coupling ring using a beryllium-copper crescent washer
- Freely rotating captured insert inside the clamp-nut assembly
- Stepped captured insert inside the clamp-nut assembly
- 360° metal-to-metal, sandwich braid capture of the outer-braid-to-cone assembly. (No insulation between the clamping surfaces)
- Machined barb on the end of the cone assembly

#### Wrench Crimp Benefits

- Faster, easier assembly
- Prevents pistoning of the center contact when cable is flexed. Does not rely on cable for positioning.
- Pre-loading the ring assures positive full mating. Reduces intermittences and rocking of mated connector. Assures mating in rugged applications.
- Permits braid and jacket clamping without rotary movement. Prevents breaking the center conductor. Prevents twisting/tearing the braid. Increases connector-to-cable tensile pull-strength.
- Grips the cable's outer jacket (25% of cable strength). Increases connector-to-cable tensile pull-strength.
- Provides a true metal-to-metal continuous shield which minimizes EMI/RFI, PTFE; jacket cold-flow problems. Increases connector-to-cable tensile pull-strength.
- Grabs the inside of the cable braid for easier assembly. Enhances the strength of the braid and jacket clamp.



*Hermetically Sealed Coax Connectors available, contact the factory.*

# MINIATURE COAX 20/220 SERIES BNC PLUGS & JACKS

UPL220 Shown

**CABLE PLUG** 50Ω **PL220-**

**TOOL CRIMP** 75Ω **UPL220-**

PL20-1 Shown

**CABLE PLUG** 50Ω **PL20-**

**WRENCH CRIMP** 75Ω **UPL20-**

PL21-1 Shown

**BULKHEAD PLUG** 50Ω **PL21**

**FRONT MOUNT, SOLDER POT** 75Ω **UPL21**

**W/ SOLDER LUG** 50Ω **PL21SL**

75Ω **UPL21SL**

Mounting Hole: C2.085

**CABLE PLUG** 75Ω **UPLR220-**

**90° RIGHT ANGLE, FULL CRIMP**

**CABLE PLUG** 75Ω **UPLFF220-**

**45° ANGLE, FULL CRIMP**

**CABLE JACK** 50Ω **CJ20-**

**WRENCH CRIMP** 75Ω **UCJ20-**

CJ220-001 Shown

**CABLE JACK** 50Ω **CJ220-**

**TOOL CRIMP** 75Ω **UCJ220-**

**BULKHEAD CABLE JACK** 50Ω **BJ220-**

**REAR MOUNT, TOOL CRIMP** 75Ω **UBJ220-**

Mounting Hole: D3.100

**BNC ADAPTER** 75Ω BNC **UADRMF220**

BN23 Shown

**BNC "T" ADAPTER** 50Ω **BN23**

75Ω **UBN23**

**BNC COUPLING ADAPTER** 50Ω **AD28**

(Barrel connector) 75Ω **UAD28**

**BNC COUPLING ADAPTER** 50Ω **AD228**

(Barrel connector) 75Ω **UAD228**

Ø .433 MAX

Refers to Cable Group Table, see pages 82-124. "D" mounting holes are on page 63.



## MINIATURE COAX 20/220 SERIES BNC BULKHEAD JACKS

<p>BJ26-1 Shown</p> <p><b>INSULATED BULKHEAD CABLE JACK</b> WRENCH CRIMP, REAR MOUNT</p> <p>50Ω <b>BJ26-</b>  75Ω <b>UBJ26-</b> </p> <p>Mounting Hole: D2.187 GF-Ground filter version page 38</p>	<p><b>NON-INSULATED BULKHEAD JACK</b> FEED-THROUGH</p> <p>50Ω <b>BJ224</b> 75Ω <b>UBJ224</b></p> <p>Mounting Hole: DD3.156</p>
<p>BJ27 Shown</p> <p><b>INSULATED BULKHEAD JACK</b></p> <p>FRONT MOUNT, SOLDER POT</p> <p>50Ω <b>BJ27</b> 75Ω <b>UBJ27</b></p> <p>Mounting Hole: D3.147</p>	<p><b>INSULATED BULKHEAD JACK</b> RECESSED INSULATED ADAPTER (RIA) FEED-THROUGH</p> <p>75Ω <b>UBJ224-RIA</b></p>
<p>BJ29-1 Shown</p> <p><b>BULKHEAD CABLE JACK</b> REAR MOUNT, WRENCH CRIMP</p> <p>50Ω <b>BJ29-</b>  75Ω <b>UBJ29-</b> </p> <p>Mounting Holes: D3.218 (D2.218-Cable Groups 6, 6E, 51, 52)</p>	<p><b>BULKHEAD JACK</b> FRONT MOUNT, SOLDER POT</p> <p>50Ω <b>BJ20</b> 75Ω <b>UBJ20</b></p> <p>W/ SOLDER LUG</p> <p>50Ω <b>BJ20SL</b> 75Ω <b>UBJ20SL</b></p> <p>Mounting Hole: D5.125</p>
<p>BJ23 Shown</p> <p><b>BULKHEAD JACK</b> NON-INSULATED</p> <p>50Ω <b>BJ23</b> 75Ω <b>UBJ23</b></p> <p>Mounting Hole: D3.147</p> <p><b>INSULATED BULKHEAD CABLE JACK</b> REAR MOUNT, SOLDER POT</p> <p>50Ω <b>BJ21</b> 75Ω <b>UBJ21</b></p> <p>Mounting Hole: D3.147</p>	<p><b>INSULATED BULKHEAD JACK</b> FEED-THROUGH</p> <p>50Ω <b>BJ228</b> 75Ω <b>UBJ228</b></p> <p>Mounting Hole: DD3.156</p>
<p><b>BULKHEAD JACK</b> FEED-THROUGH NON-INSULATED</p> <p>50Ω <b>BJ24</b> 75Ω <b>UBJ24</b></p> <p>Mounting Hole: DD3.100, (Hermetically sealed version available, call factory).</p>	<p>BJ28 Shown</p> <p><b>INSULATED BULKHEAD JACK</b> FEED-THROUGH</p> <p>50Ω <b>BJ28</b> 75Ω <b>UBJ28</b></p> <p>Mounting Hole: D3.156 (Hermetically sealed version available, call factory). GF-Ground Filter version available page 43.</p>

Refers to Cable Group Table, see pages 82-124. "D" mounting holes are on page 63.

# COAX 20/220 SERIES CIRCUIT BOARD JACKS

## Edge Mount Circuit Board Jacks

Trompeter manufactures a wide selection of circuit board jacks.

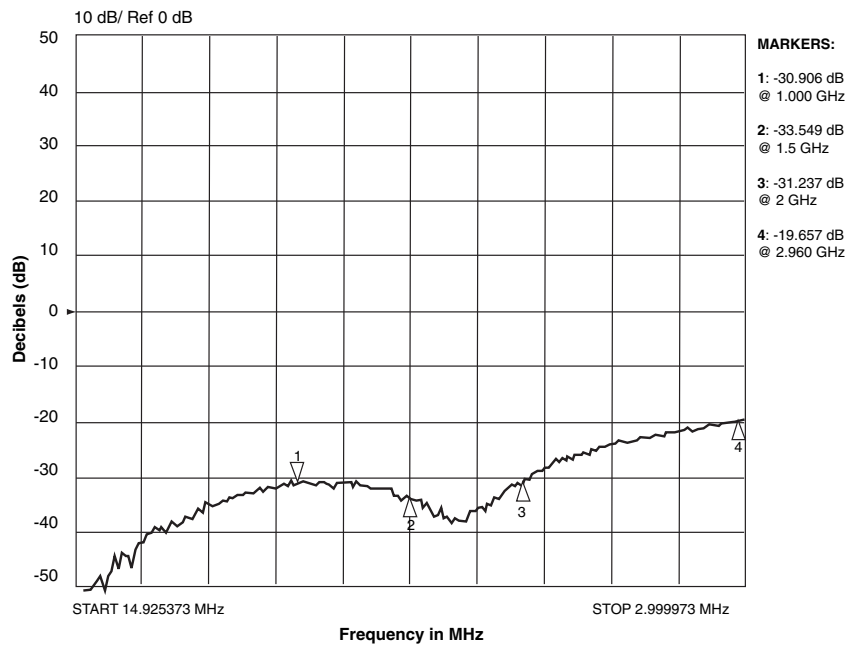

### CIRCUIT BOARD EDGE MOUNT COAX "BNC" STYLE RECEPTACLE 75Ω

Part Number	Board Thickness
UCBJE20-1	.060 - .064
UCBJE20-2	.028 - .033

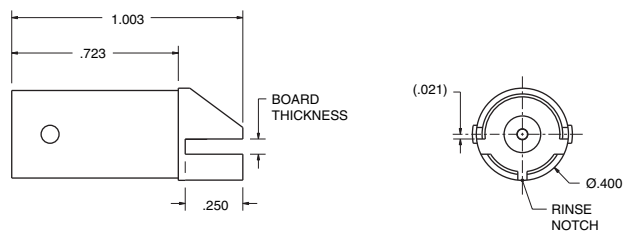

### CIRCUIT BOARD BULKHEAD EDGE MOUNT COAX "BNC" STYLE RECEPTACLE 75Ω

Max Panel Thickness: .179

Part Number	Board Thickness
UCBBJE20-1	.060 - .064
UCBBJE20-2	.028 - .033
UCBBJE20-3	.084
UCBBJE20-4	.120

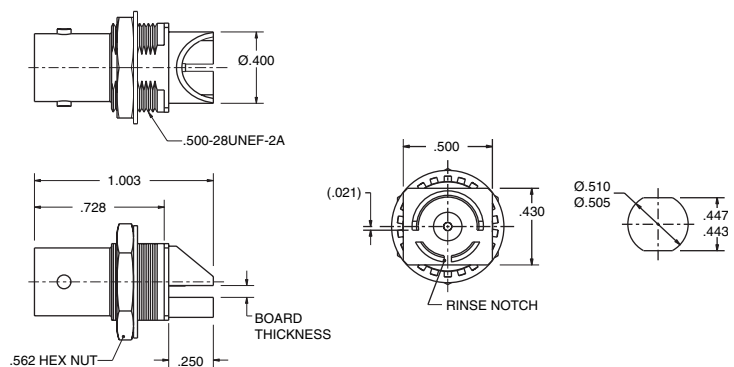

## CoAX 20/220 SERIES Circuit Board Jacks

### Separable Circuit Board Jacks

Trompeter manufactures a wide selection of circuit board jacks.

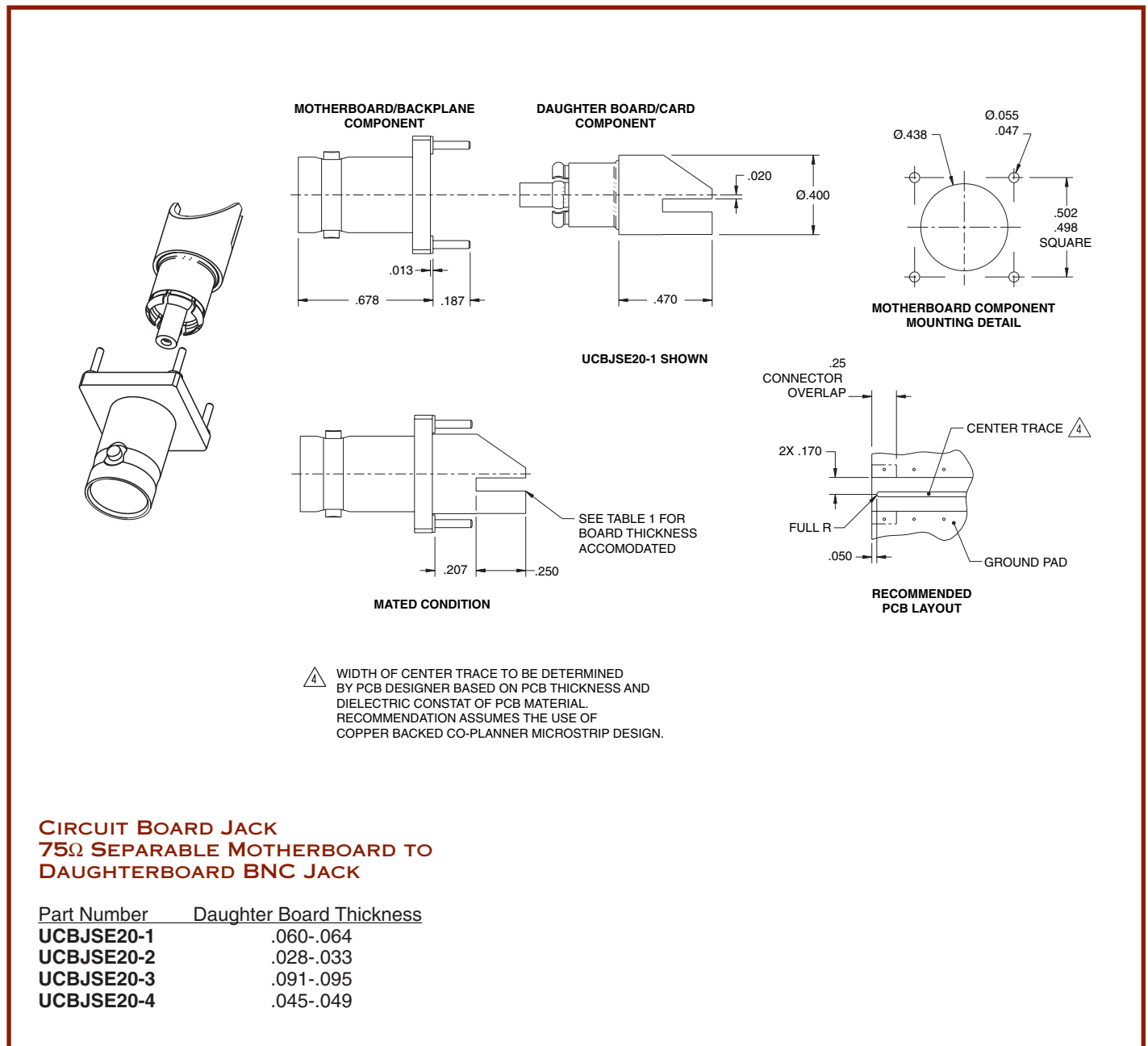

# COAX 20/220 SERIES CIRCUIT BOARD JACKS

## Circuit Board Jacks...

Trompeter manufactures a wide selection of circuit board jacks, Shown below are the most commonly requested designs. For custom designs, contact the factory or fill out the *Custom Products Request Form* on page 137 and fax it to us.

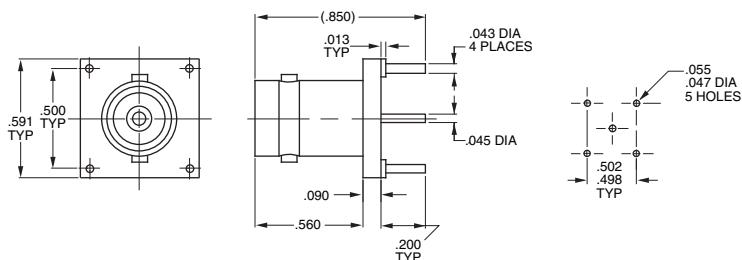

**CIRCUIT BOARD JACK**  
STRAIGHT, 4-LEG

75Ω

**UCBJ20F**

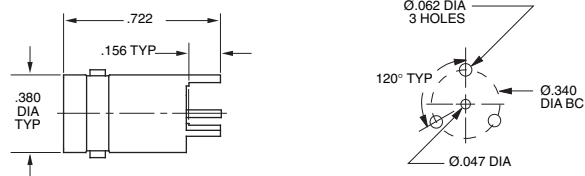

**CIRCUIT BOARD JACK**  
STRAIGHT, 3-LEG

50Ω

**CBJ20**

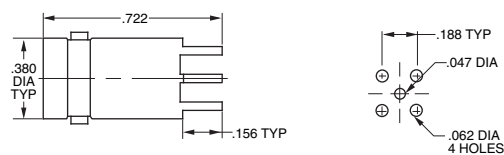

**CIRCUIT BOARD JACK**  
STRAIGHT, 4-LEG

50Ω

**CBJ22**

## CoAX 20/220 SERIES Circuit Board Jacks

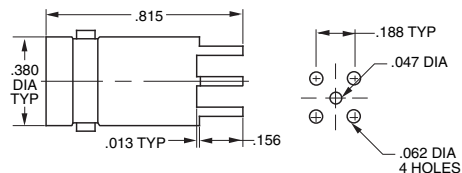

**CIRCUIT BOARD JACK**  
STRAIGHT, 4-LEG

75Ω

**UCBJ224**

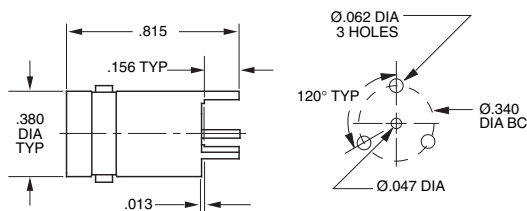

**CIRCUIT BOARD JACK**  
STRAIGHT, 3-LEG

75Ω

**UCBJ223**

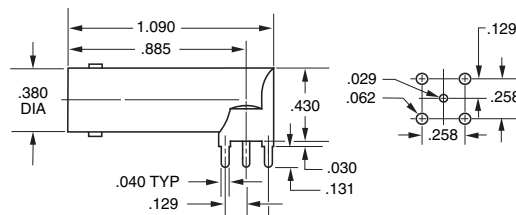

**RIGHT ANGLE COAX BNC**  
CIRCUIT BOARD JACK

75Ω

**UCBJR220**

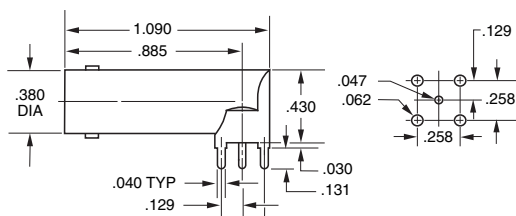

**RIGHT ANGLE COAX BNC**  
CIRCUIT BOARD JACK

50Ω

**CBJR220**

MODEL NO.	LTR CODE	OHM	A DIM	B DIM	C DIM	D DIM	E DIM
CBJR20	-	50	.046	.24	.090	.050	.0625
UCBJR20	-	75	.029	.24	.090	.050	.0625

MODEL NO.	LTR CODE	OHM	A DIM	B DIM	C DIM	D DIM	E DIM
CBJR20A	A	50	.046	.34	.090	.058	.070
UCBJR20A	A	75	.029	.34	.090	.058	.070

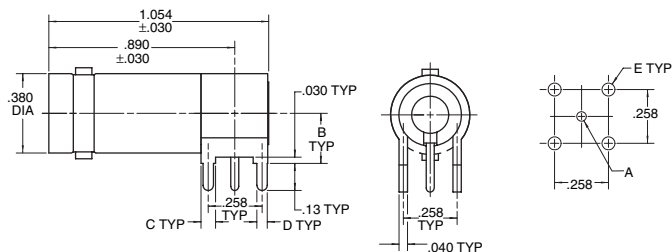

**CIRCUIT BOARD JACK**  
RIGHT ANGLE, TALL VERSION

50Ω

**CBJR20A**

75Ω

**UCBJR20A**

# COAX 20/220 SERIES CIRCUIT BOARD JACKS

## NON-INSULATED CIRCUIT BOARD BULKHEAD JACK

STRAIGHT, 4-LEG  
Mounting Hole: D3.109

75Ω

UCBBJ29

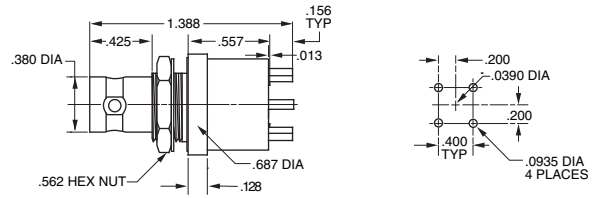

## INSULATED CIRCUIT BOARD BULKHEAD JACK COAXIAL BNC GROUND FILTER INSULATED 4-POST

STRAIGHT  
Mounting Hole: .093

50Ω  
75Ω

CBBJ26GF  
UCBBJ26GF

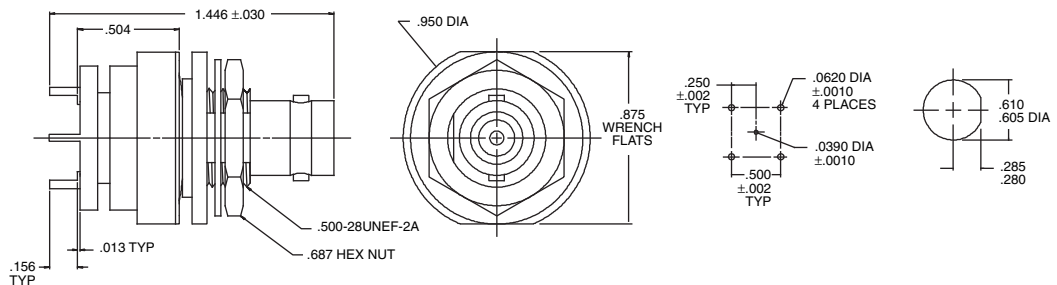

## INSULATED CIRCUIT BOARD BULKHEAD JACK

STRAIGHT  
Mounting Hole: D3.156

50Ω

CBBJ26

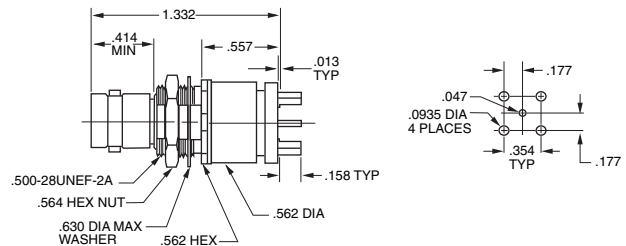

## CIRCUIT BOARD BULKHEAD JACK

STRAIGHT  
Mounting Hole: D3.060

75Ω

UCBBJ23

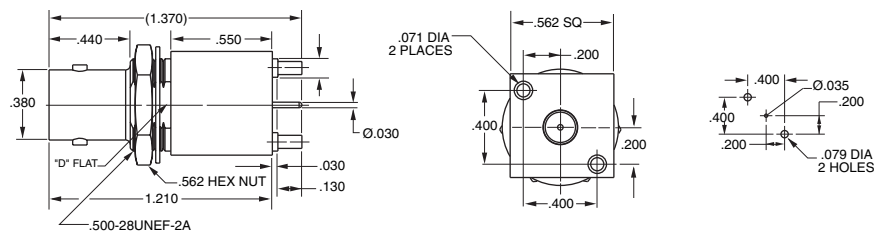



## CoAX 20/220 SERIES Circuit Board Jacks

MODEL NO.	LTR CODE	OHM	Ø
CBBJR229	-	50	.046
UCBBJR229	-	75	.029

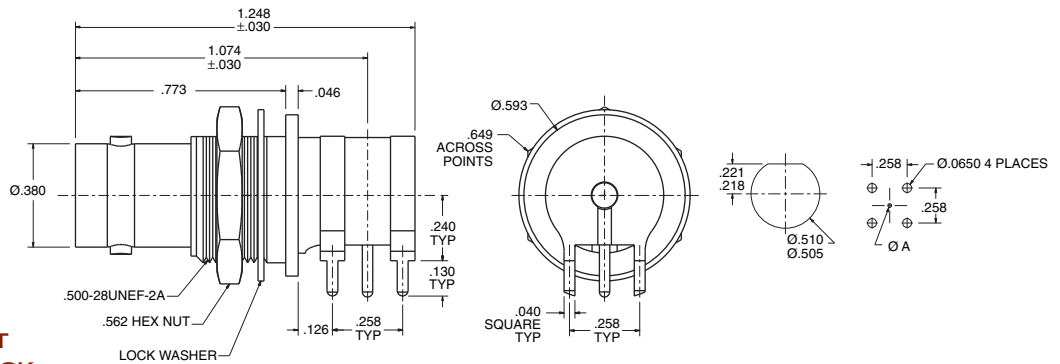

### RIGHT ANGLE CIRCUIT BOARD BULKHEAD JACK

ONE PIECE BODY

50Ω

**CBBJR229**

75Ω

**UCBBJR229**

Maximum Panel Thickness: .179 D-Hole: D3

MODEL NO.	LTR CODE	OHM	A DIM	B DIM	C DIM	D DIM	E DIM
CBBJR29	-	50	.046	.24	.090	.050	.0625
UCBBJR29	-	75	.029	.24	.090	.050	.0625
CBBJR29A	A	50	.046	.34	.090	.058	.070
UCBBJR29A	A	75	.029	.34	.090	.058	.070

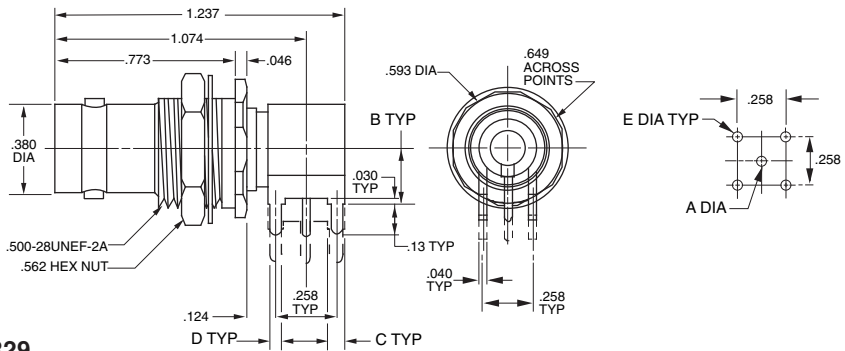

### RIGHT ANGLE CIRCUIT BOARD BULKHEAD JACK

NON-INSULATED

50Ω

**CBBJR29**

NON-INSULATED

75Ω

**UCBBJR29**

\* Add "A" for tall versions

Example: **CBBJR29A**

Mounting Holes: D3.156 (Insulated), D3.179 (Non-Insulated)

MODEL NO.	LTR CODE	OHM	A DIM	B DIM	C DIM	D DIM	E DIM
CBBJR26	-	50	.046	.24	.090	.050	.0625
UCBBJR26	-	75	.029	.24	.090	.050	.0625
CBBJR26A	A	50	.046	.34	.090	.058	.070
UCBBJR26A	A	75	.029	.34	.090	.058	.070

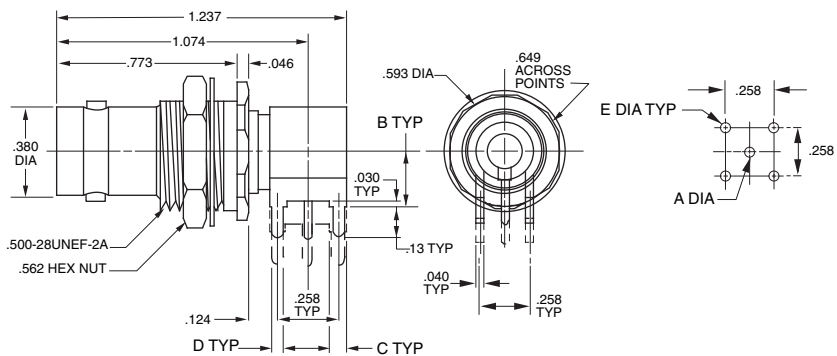

### RIGHT ANGLE CIRCUIT BOARD BULKHEAD JACK

INSULATED

50Ω

**CBBJR26**

INSULATED

75Ω

**UCBBJR26**

\* Add "A" for tall versions

Example: **CBBJR26A**

Mounting Holes: D3.156 (Insulated), D3.179 (Non-Insulated)

# MINI-WECO Coax Circuit Board Jacks

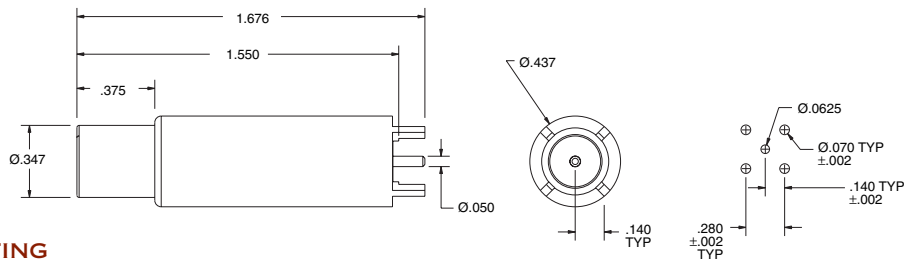

**CIRCUIT BOARD MOUNTING**  
**MINI-WECO COAXIAL PATCH JACK**  
**75Ω (.296 SIZE) CBJ12**

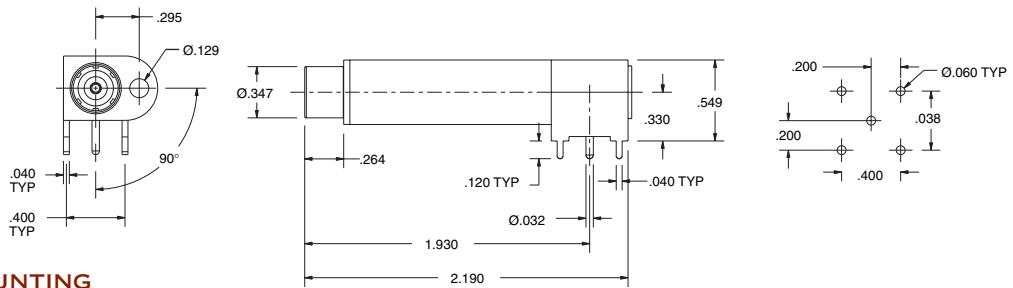

**CIRCUIT BOARD MOUNTING**  
**MINI-WECO COAXIAL PATCH JACK**  
**RIGHT ANGLE**  
**75Ω (.296 SIZE) 105-1880**

MODEL NO.	LTR CODE	B DIM
CBBJR12	-	.24
CBBJR12A	A	.34

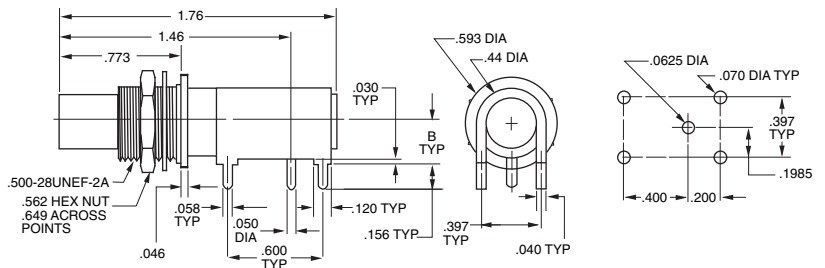

**CIRCUIT BOARD BULKHEAD MOUNTING**  
**MINI-WECO PATCH JACK**  
**75Ω RIGHT ANGLE LONG LEG VERSION**  
**CBBJR12 B = .24**  
**CBBJR12A B = .34**  
 Mounting Hole: D3.250

MODEL NO.	LTR CODE	B DIM
CBJR12	-	.24
CBJR12A	A	.34

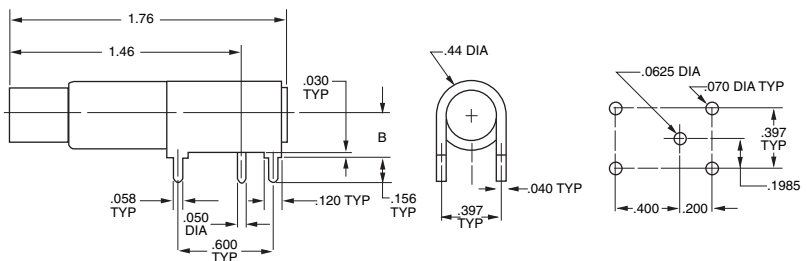

**CIRCUIT BOARD MOUNTING**  
**MINI-WECO PATCH JACK**  
**75Ω RIGHT ANGLE LONG LEG VERSION**  
**CBJR12 B = .24**  
**CBJR12A B = .34**

## MINIATURE COAX 250 SERIES, MINI-BNC PLUGS & JACKS

The mini-BNC 250 RF connector series from Trompeter was designed specifically for DS3 telco coaxial central office applications to allow higher interconnect density while preserving the positive characteristics of the Trompeter full size BNC. In fact, the 250 series provides for higher density of interconnects in a given area.

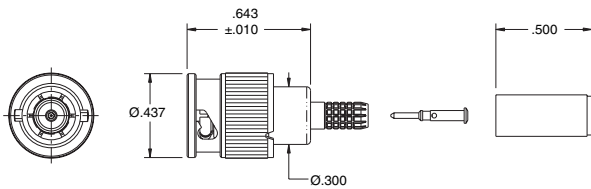

**MINIATURE BNC (M-BNC) COAXIAL PLUG**  
STRAIGHT 75Ω **UPL250-**

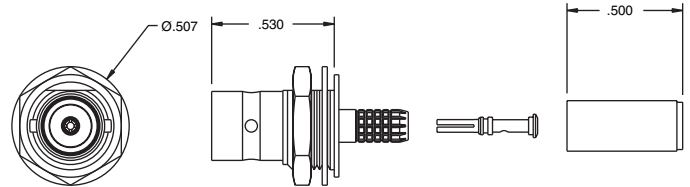

**MINIATURE BNC (M-BNC) COAXIAL BULKHEAD JACK**  
STRAIGHT 75Ω **UBJ250-**

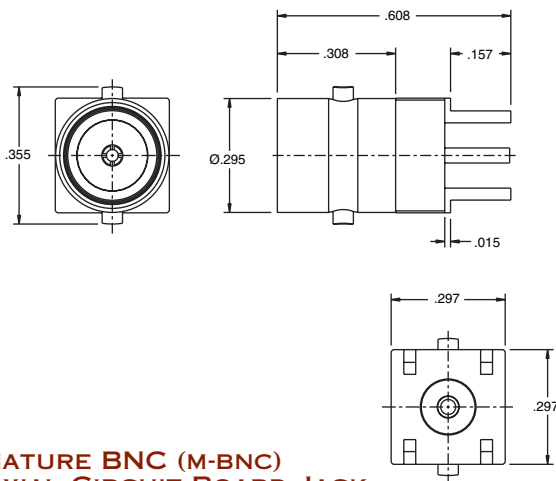

**MINIATURE BNC (M-BNC) COAXIAL CIRCUIT BOARD JACK**  
STRAIGHT 75Ω **UCBJ250-N**  
75Ω **UCBJ250-G**

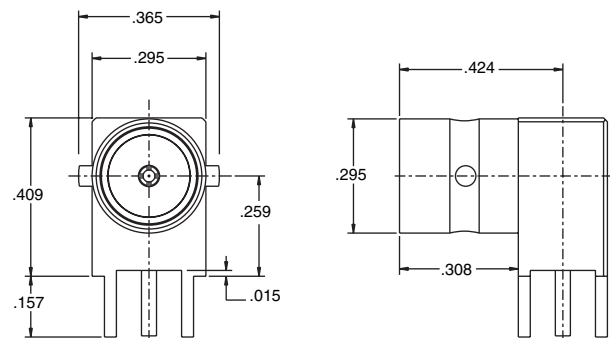

**MINIATURE BNC (M-BNC) COAXIAL CIRCUIT BOARD JACK**  
RIGHT ANGLE 75Ω **UCBJR250-N**  
75Ω **UCBJR250-G**

Part Number	Description	Plating	Bulkhead Mount	PCB OA Thickness
<b>UPL250-</b>	Straight plug M-BNC series	ni	n/a	
<b>UPLR250-</b>	Right angle plug M-BNC series	ni	n/a	
<b>UBJ250-</b>	Bulkhead cable jack	ni	yes	
<b>UCBJ250-G</b>	Straight PCB-mounted jack	au	no	
<b>UCBJ250-N</b>	Straight PCB-mounted jack	ni	no	
<b>UCBBJ250-G</b>	Straight PCB-mounted jack	au	yes	
<b>UCBBJ250-N</b>	Straight PCB-mounted jack	ni	yes	
<b>UCBJR250-G</b>	Right angle PCB-mounted jack	au	no	
<b>UCBJR250-N</b>	Right angle PCB-mounted jack	ni	no	
<b>UCBBJR250-G</b>	Right angle PCB-mounted jack	au	yes	
<b>UCBBJR250-N</b>	Right angle PCB-mounted jack	ni	yes	
<b>UCBJE250-1</b>	PCB-edge mounted SMT jack	au	no	0.032
<b>UCBJE250-2</b>	PCB-edge mounted SMT jack	au	no	0.064
<b>UCBBJE250-1</b>	PCB-edge mounted SMT jack	au	yes	0.032
<b>UCBBJE250-2</b>	PCB-edge mounted SMT jack	au	yes	0.064
<b>UAD258</b>	M-BNC jack to M-BNC jack adapter, Barrel adapter	ni	yes	



Refers to Cable Group Table, see pages 82-124. "D" mounting holes are on page 63.

# MINIATURE COAX THREADED 40/240 SERIES, TNC

PL40-1 Shown

**CABLE PLUG** 50Ω **PL40-**   
**WRENCH CRIMP** 75Ω **UPL40-**

CJ40-1 Shown

**CABLE JACK** 50Ω **CJ40-**   
**WRENCH CRIMP** 75Ω **UCJ40-**

**CABLE PLUG** 50Ω **PL240-**   
**TOOL CRIMP** 75Ω **UPL240-**

**CABLE JACK** 50Ω **CJ240-**   
**TOOL CRIMP** 75Ω **UCJ240-**

**BULKHEAD PLUG** 50Ω **PL41**   
**FRONT MOUNT, SOLDER POT** 75Ω **UPL41**

**W/ SOLDER LUG** 50Ω **PL41SL**   
 75Ω **UPL41SL**

Mounting Hole: C2.093

**TNC COUPLING ADAPTER** 50Ω **AD48**   
**(BARREL CONNECTOR)** 75Ω **UAD48**

BJ48 Shown

**INSULATED BULKHEAD JACK** 50Ω **BJ48**   
**FEED-THROUGH** 75Ω **UBJ48**

Mounting Hole: D3.156  
 GF-Ground filter version page 43

MODEL NO.	LTR CODE	OHM	A DIM	B DIM	C DIM	D DIM	E DIM
CBJR40	-	50	.046	.24	.070	.050	.0625
UCBJR40	-	75	.029	.24	.070	.050	.0625
CBJR40A	A	50	.046	.34	.090	.058	.070
UCBJR40A	A	75	.029	.34	.090	.058	.070

**RIGHT ANGLE CIRCUIT BOARD MOUNTING TNC RECEPTACLE** 50Ω **CBJR40**   
 75Ω **UCBJR40**

Add "A" for tall versions (see chart)

Refers to Cable Group Table, see pages 82-124. "D" mounting holes are on page 63.

## MINIATURE COAX THREADED 40/240 SERIES, TNC BULKHEAD JACKS

BJ41 Shown

**INSULATED BULKHEAD JACK**  
REAR MOUNT, SOLDER POT

50Ω **BJ41**  
75Ω **UBJ41**  
Mounting Hole: D3.147

BJ40 Shown

**BULKHEAD JACK**  
SOLDER POT

50Ω **BJ40**  
75Ω **UBJ40**  
W/ SOLDER LUG  
50Ω **BJ40SL**  
75Ω **UBJ40SL**  
Mounting Hole: D5.125

BJ46-1 Shown

**INSULATED BULKHEAD JACK**  
REAR MOUNT, WRENCH CRIMP

50Ω **BJ46-1**  
75Ω **UBJ46-1**  
Mounting Hole: D2.187  
GF-Ground filter version page 43

BJ47 Shown

**INSULATED BULKHEAD JACK**  
FRONT MOUNT, SOLDER POT

50Ω **BJ47**  
75Ω **UBJ47**  
Mounting Hole: D3.147

BJ246-001 Shown

**INSULATED BULKHEAD JACK**  
REAR MOUNT, TOOL CRIMP

50Ω **BJ246-001**  
75Ω **UBJ246-001**  
Mounting Hole: D2.187  
GF-Ground filter version pg 43

BJ49-1 Shown

**BULKHEAD CABLE JACK**  
WRENCH CRIMP

50Ω **BJ49-1**  
75Ω **UBJ49-1**  
Mounting Hole: D3.218 / D2.218 (Cable Groups 6, 6E, 51, 52)

MODEL NO.	LTR CODE	OHM	A DIM	B DIM	C DIM	D DIM	E DIM
CBBJR46	-	50	.046	.24	.090	.050	.0625
UCBBJR46	-	75	.029	.24	.090	.050	.0625
CBBJR46A	A	50	.046	.34	.090	.058	.070
UCBBJR46A	A	75	.029	.34	.090	.058	.070

CBBJR46 Shown

**INSULATED CIRCUIT BOARD JACK**  
RIGHT ANGLE

50Ω **CBBJR46**  
75Ω **UCBBJR46**  
50Ω **CBBJR46A**  
75Ω **UCBBJR46A**  
Mounting Hole: D3.156  
"A" refers to tall versions

BJ249 Shown

**BULKHEAD CABLE JACK**  
TOOL CRIMP

50Ω **BJ249**  
Mounting Hole: D3.218  
D2.218 (Cable Groups 6, 6E, 51, 52)

MODEL NO.	LTR CODE	OHM	A DIM	B DIM	C DIM	D DIM	E DIM
CBBJR49	-	50	.046	.24	.090	.050	.0625
UCBBJR49	-	75	.029	.24	.090	.050	.0625
CBBJR49A	A	50	.046	.34	.090	.058	.070
UCBBJR49A	A	75	.029	.34	.090	.058	.070

CBBJR49 Shown

**CIRCUIT BOARD JACK**  
BULKHEAD MOUNT  
RIGHT ANGLE

50Ω **CBBJR49**  
75Ω **UCBBJR49**  
Add "A" for tall versions  
Mounting Hole: D3.230

△ Refers to Cable Group Table, see pages 82-124. "D" mounting holes are on page 63.

# PUSH-ON COAX 120 SERIES

These BNC/TNC push-on jacks and plugs are designed for (U)PL123 blind mate rack and panel applications. The male plugs mate (U)PL122 with any BNC/TNC jack and are ideally suited for test/cable applications.

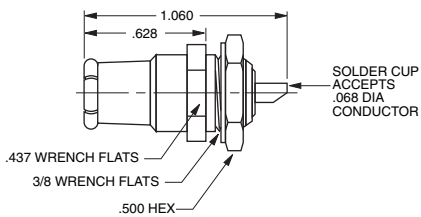
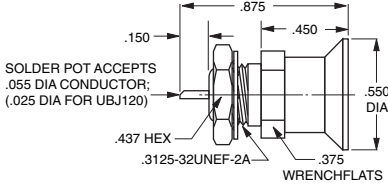
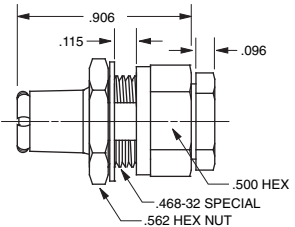
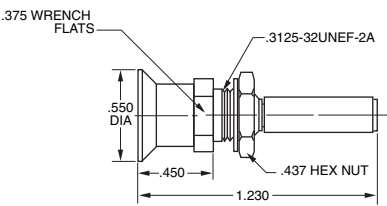
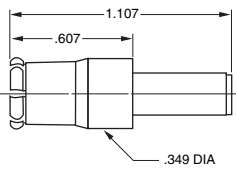
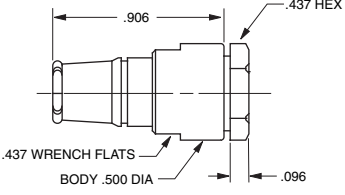
<p>PL121 Shown</p>  <p><b>PANEL PLUG</b> 50Ω <b>PL121</b>  <b>FRONT MOUNT, SOLDER POT</b> 75Ω <b>UPL121</b></p> <p><b>W/ SOLDER LUG</b> 50Ω <b>PL121SL</b>  75Ω <b>UPL121SL</b></p> <p>Mounting Hole: C2.093</p>	 <p><b>BULKHEAD JACK</b> 50Ω <b>BJ120</b>  <b>FRONT MOUNT, SOLDER LUG</b> 75Ω <b>UBJ120</b></p> <p><b>W/ SOLDER LUG</b> 50Ω <b>BJ120SL</b>  75Ω <b>UBJ120SL</b></p> <p>Mounting Hole: C1.120</p>
<p>PL122 Shown</p>  <p><b>PANEL PLUG</b> 50Ω <b>PL122-<sup>△</sup></b>  <b>REAR MOUNT, CABLE ENTRY</b> 75Ω <b>UPL122-<sup>△</sup></b></p> <p>Mounting Hole: DD5.187</p>	 <p><b>BULKHEAD CABLE JACK</b> 50Ω <b>BJ120C-<sup>△</sup></b>  <b>FRONT MOUNT, TOOL CRIMP</b> 75Ω <b>UBJ120C-<sup>△</sup></b></p> <p>Limited Cable Groups  Mounting Hole: C1.120</p>
<p>PL223-001 Shown</p>  <p><b>CABLE PLUG</b> 50Ω <b>PL223-<sup>△</sup></b>  <b>TOOL CRIMP</b> 75Ω <b>UPL223-<sup>△</sup></b></p>	<p>PL123-2 Shown</p>  <p><b>CABLE PLUG</b> 50Ω <b>PL123-<sup>△</sup></b>  <b>WRENCH CRIMP</b> 75Ω <b>UPL123-<sup>△</sup></b></p>

<sup>△</sup> Refers to Cable Group Table, see pages 82-124. "D" mounting holes are on page 63.



## 110 SERIES 1.6/5.6 DIN CONNECTORS

Trompeter's 110 series connectors are 30% smaller than the standard BNC currently used for the Coax Central Office termination. With this space savings, 72 interconnects can be placed in the same 1 rack unit panels as 52 BNCs. The 110 series of connectors is available in the following: cable

plug, cable jack, a U-Link for connecting two jacks, a right angle circuit board jack, and BNC to DIN adapters.

Trompeter's 110 series works with all the cables currently in use in the central office environment and like all Trompeter connectors, can be made to accommodate any coax cable changes.

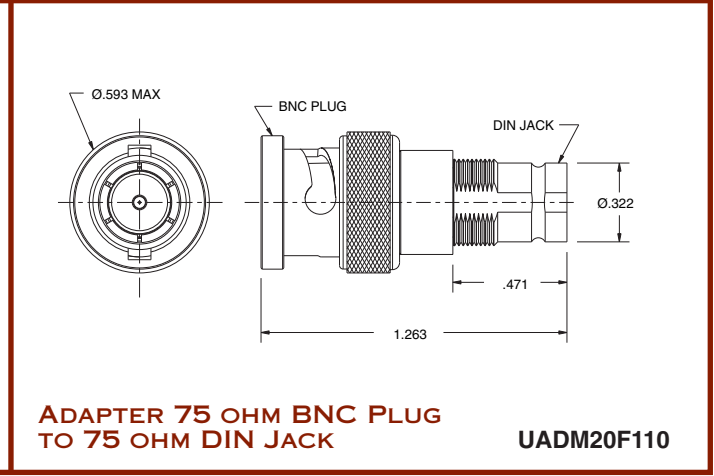
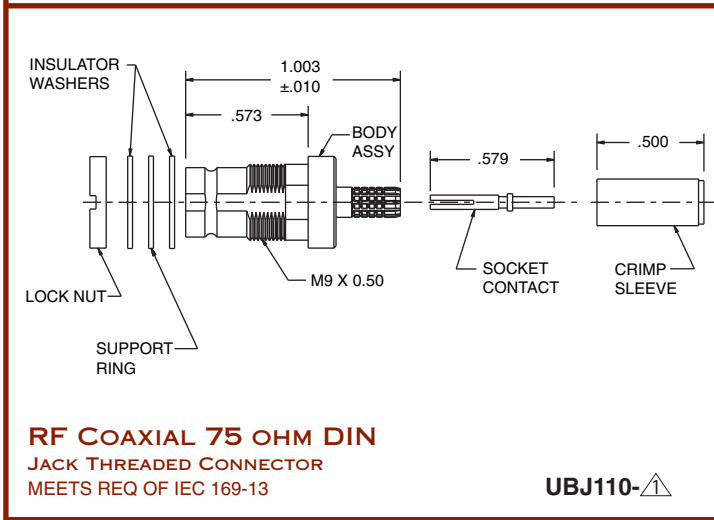
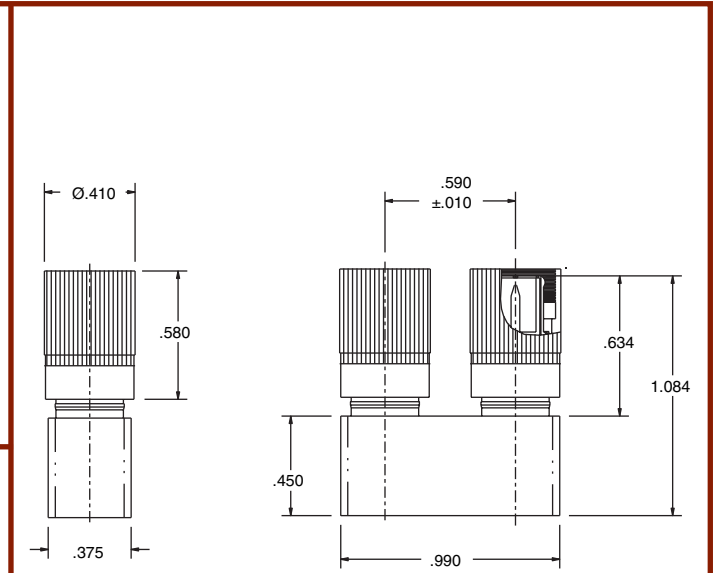
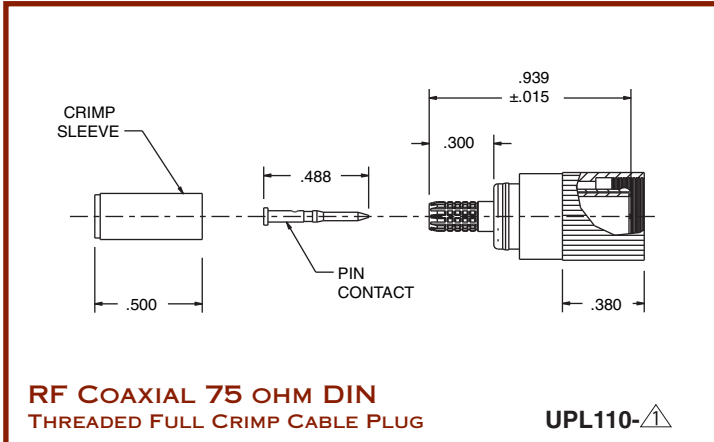

△ Refers to Cable Group Table, see pages 82-124.

# COAXIAL GROUND FILTER BULKHEAD JACKS

## Coaxial Ground Filter Bulkhead Jacks

Designated in catalog pages by "GF".

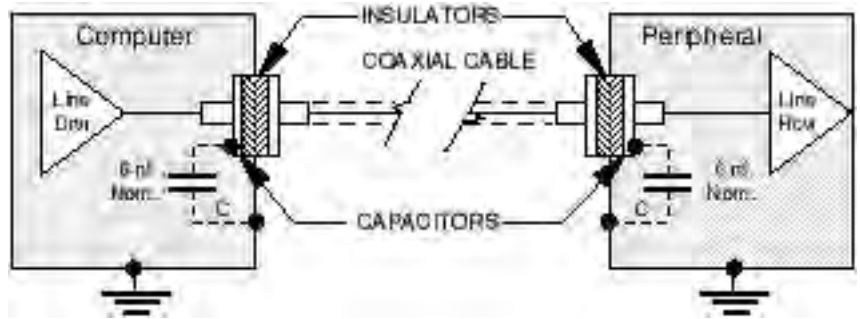
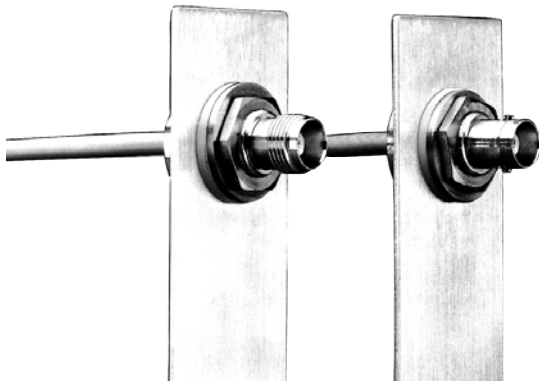

### Ground Filter Specifications

RF Insertion Loss: ..... 0.1 dB max. to 1 GHz  
 Dissipation Factor: ..... 5% max. @ 1 KHz & 25°C  
 Voltage Rating: ..... 200 VDC @ sea level & 25°C  
 Capacitance: ..... 4nF min., 10nF max. @ 1 KHz & 25°C  
 Insulation Resistance: ..... 1 Gohm min. @ 200 VDC & 25°C  
 Dielectric Withstanding  
 Voltage: ..... 500 VDC @ sea level & 25°C for 1 minute  
 Filter RF Attenuation: ..... 1MHz- 1dB, 3MHz- 2dB  
 10MHz- 8dB, 30MHz- 16dB, 100/300/1000MHz- 30dB

These connectors reduce radiated electrical noise to meet the EMI/RFI requirements of F.C.C. Regulation on RFI Interference-Part 15, Subpart J, as a result of Docket 20780, which limits allowable computer and peripheral equipment emissions to a range of 20 to 1000 MHz. Radiated interference from HF components and electrical pulse harmonics are avoided by using a built-in capacitor which acts as a high pass filter to attenuate spurious HF signals while bypassing ground loop, directing contact current flow harmlessly to ground.

Connector Type	Mounting Hole	Ohm	Part Number
<b>BNC, Wrench Crimp</b>	D8.094	50Ω/75Ω	(U)BJ26GF- <sup>△</sup>
<b>BNC, Tool Crimp</b>	D8.094	50Ω	BJ226GF- <sup>△</sup>
<b>BNC, Feed-through</b>	D8.094	50Ω/75Ω	(U)BJ28GF
<b>BNC, Circuit board</b>	D8.093	50Ω/75Ω	(U)CBBJ26GF
<b>TNC, Wrench Crimp</b>	D8.094	50Ω/75Ω	(U)BJ46GF- <sup>△</sup>
<b>TNC, Tool Crimp</b>	D8.094	50Ω	BJ246GF- <sup>△</sup>
<b>TNC, Feed-through</b>	D8.094	50Ω/75Ω	(U)BJ48GF
<b>TNC, Circuit board</b>	D8.093	50Ω/75Ω	(U)CBBJ46GF

Designate 75Ω version by prefix "U".

### BNC Attenuator

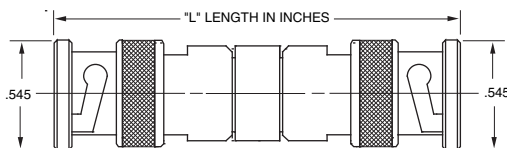

Replace Ω with impedance and dB with dB required.  
 Example: TNA-75-20-BNC

CONNECTOR TYPE	L	PART NUMBER
50Ω plug & jack	3.24"	TNA-Ω-dB-BNC
75Ω plug & jack	3.24"	UTNA-Ω-dB-BNC
50Ω plugs	3.17"	TNA-Ω-dB-BNC/M
75Ω plugs	3.17"	UTNA-Ω-dB-BNC/M
50Ω jacks	3.30"	TNA-Ω-dB-BNC/F
75Ω jacks	3.30"	UTNA-Ω-dB-BNC/F

Video frequency 10 MHz max. attenuation 20 dB max.

### BNC Pads

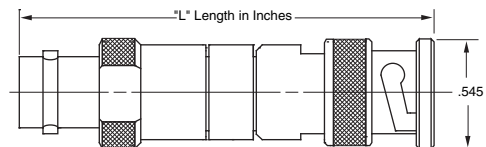





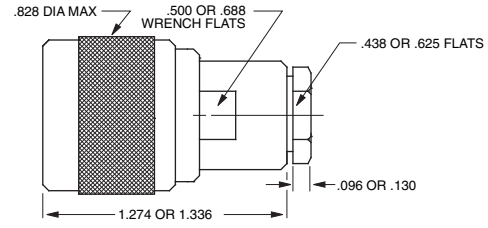

SCHEMATIC	IMPEDANCE	L	PART NUMBER
	50Ω 75Ω	2.16"	TNA2-R UTNA2-R
	50Ω 75Ω	2.16"	TNA3-R UTNA3-R
	50Ω 75Ω	3.23"	TNA4-R UTNA4-R

<sup>△</sup> Refers to Cable Group Table, see pages 82-124. "D" mounting holes are on page 63.

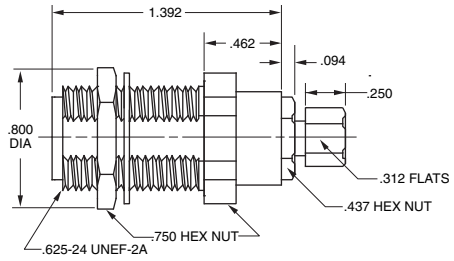
## Coax "N" CONNECTORS, 90 SERIES

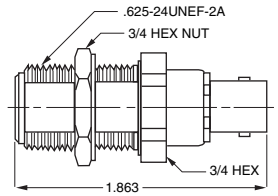
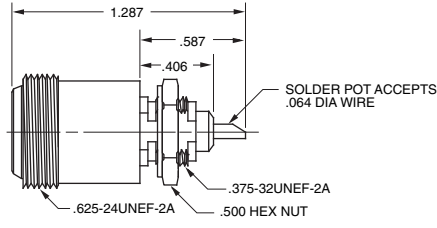
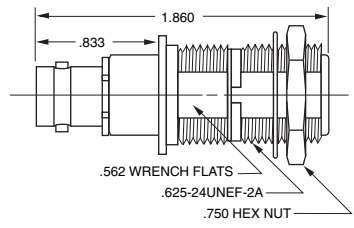
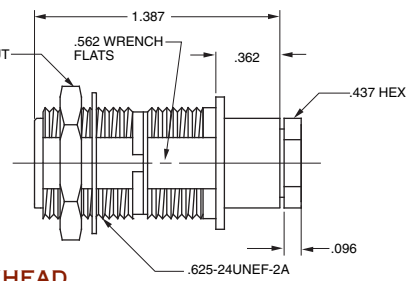
Trompeter's 90 Series incorporates many of the features of our BNC lines including 3-piece wrench crimp configuration, gold plated captive center contacts, beryllium copper female contacts, and PTFE dielectrics. The 90 Series will also accommodate nonflammable plenum coax cables.

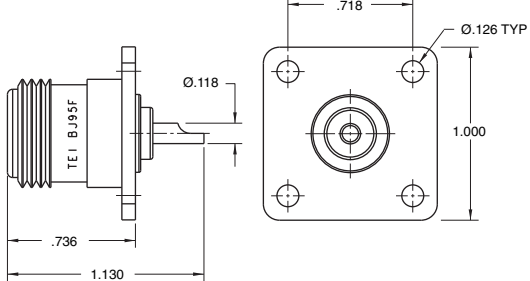
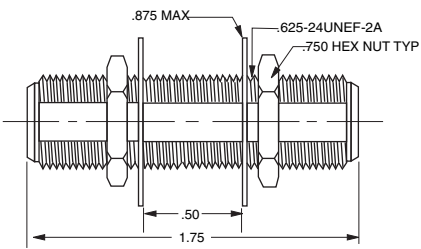
<p>PL95-1 and -6 Shown</p>  <p><b>CABLE PLUG WRENCH CRIMP</b> 50Ω 75Ω</p> <p><b>PL95-</b>  <b>UPL95-</b> </p> <p>Large body versions are available, contact the factory. Size depends on cable group.</p>	<p>BJ95-141 Shown</p>  <p><b>BULKHEAD CABLE JACK WRENCH CRIMP</b> 50Ω 75Ω</p> <p><b>BJ95-</b>  <b>UBJ95-</b> </p> <p>Mounting Holes: DD4.310 (Standard body) DD1.310 (Cable Groups -6A/6B/6E, -48, -50)</p>
 <p><b>ADAPTER N TO BNC</b> 50Ω 75Ω</p> <p><b>AD95</b> <b>UAD95</b></p> <p>Mounting Hole: DD4.310</p>	 <p><b>BULKHEAD JACK SOLDER POT</b> 50Ω 75Ω</p> <p><b>J95</b> <b>UJ95</b></p> <p>Mounting Hole: D5.310</p>
 <p><b>INSULATED ADAPTER N TO BNC</b> 50Ω 75Ω</p> <p><b>ADI95</b> <b>UADI95</b></p> <p>Mounting Hole: DD4.203</p>	<p>BJ96-1 Shown</p>  <p><b>INSULATED BULKHEAD CABLE JACK WRENCH CRIMP</b> 50Ω 75Ω</p> <p><b>BJ96-</b>  <b>UBJ96-</b> </p> <p>Mounting Hole: DD4.203</p>
 <p><b>FLANGE MOUNT BULKHEAD JACK N, SOLDER POT</b> 50Ω 75Ω</p> <p><b>BJ95F</b> <b>UJ95F</b> (Not Shown)</p>	<p>BJ98-2 Shown</p>  <p><b>FEED-THRU JACK</b> 50Ω 75Ω</p> <p><b>BJ98-2</b> <b>UBJ98-2</b></p> <p>Mounting Hole: DD4.50 Options available for panels up to 2.25" thick. Call Factory.</p>

 Refers to Cable Group Table, see pages 82-124. "D" mounting holes are on page 63.

# COAX "N" CONNECTORS, 90 SERIES

# COAX "F" CONNECTORS, 130 SERIES

Trompeter's "N" Connector Series is utilized for interconnection on antenna towers, lightning protection boxes, power distribution and ancillary systems. Trompeter offers a complete line of remarkable new 50Ω "N" connectors for current industry standard flexible and corrugated cables.

Technical drawing of an N-type bulkhead jack. Dimensions include: 0.765, .755, .662, .658, .750-32UNEF-2A, 1.286, 1.00 HEX, .625-24UNEF-2A, .818, .468, Ø1.000, and .437 HEX. Components labeled include: SOLDER POT ACCEPTS Ø.095 WIRE and GASKET.

**"N" TYPE BULKHEAD JACK** 50Ω **BJ92**  
**Panel Thk: .250 MAX**

Technical drawing of an F adapter. Dimensions include: .437 HEX, .371, .662, .375-32-2A TYP, .312 WRENCH FLATS, and 1.290.

**F ADAPTER** **AD131**

Technical drawing of a right angle circuit board jack. Dimensions include: 1.867, 1.555, .930, .187, .866 DIA, .800 DIA, .072 TYP, .553 TYP, .350, .450 TYP, .575, .750 HEX NUT, .634, .553, .104 DIA 4 PLACES, and .081 DIA.

**RIGHT ANGLE CIRCUIT BOARD JACK**  
**TYPE "N" COAXIAL BULKHEAD**  
**MOUNT RECEPTACLE** 50Ω **CBBJR99**  
**DD4.310**

**BETWEEN SERIES COAXIAL FEMALE**  
**BNC TO MALE "F" ADAPTER** 75Ω **AD1300**

Technical drawing of a BNC to F adapter. Dimensions include: 1.06 ±.03, 0.50, and .437 HEX.

**F JACK**  
**AD1300**  
**75 OHM COAXIAL FEMALE BNC**  
**TO MALE "F" ADAPTER**  
**BNC PLUG**

**AD1300**  
**BNC TO "F" ADAPTER**

△ Refers to Cable Group Table, see pages 82-124. "D" mounting holes are on page 63.

## COAX "F" CONNECTORS, 130 SERIES

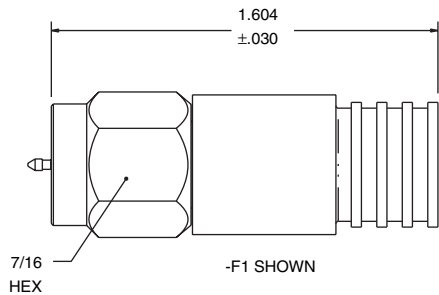

PART NO	A DIM	CABLES ACCOMMODATED
PL130C-F1	.360	COMMSCOPE 6 SERIES QUAD (P/N 5740) (P/N F6SSVV)
PL130C-F2	.324	BELDEN 6 SERIES (P/N 82120) (P/N 9114)
PL130C-F3	.360	COMMSCOPE 59 SERIES (P/N S 59 HEC)

**75 OHM MALE TYPE "F"  
COAXIAL CABLE PLUG**  
(Patent #5860833)

**PL130C-**(see dash number from chart on right)

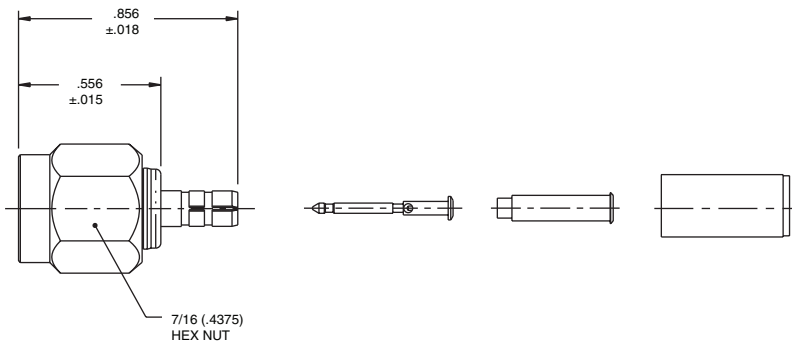

**75 OHM "F" TYPE  
TOOL CRIMP PLUG**

**PL130SC-**(see dash number from chart on right)

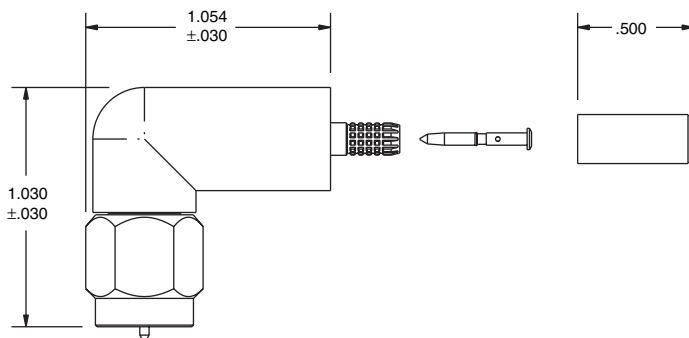

**75 OHM RIGHT ANGLE  
"F" STYLE FULL CRIMP CABLE PLUG**  
**PLR130SC-**(see dash number from chart on right)

DASH NO	CABLES ACCOMMODATED	A HEX
-001	RG-178, -196	.178
-002	HEWLETT PACKARD 8120 - 1107	.197
-003	RG-174, 316	.178
-004	RG-179, 187	.178
-005	NORTHERN ELECTRIC DBL - SHLD RG-187	.197
-006	GC875GPI, GRUMMAN DBL - SHLD RG-188	.197
-007	275-3991, MICRODOT	.178
-008	RG-195, -180 421-111, ESSEX	.178
-009	8218, BELDEN YR23023 BELDEN 21-597, ESSEX	.178
-011	RG-58, RG-141, RG-303, TCC-50-2	.213
-013	RG-59	.255
-013A	TCC-75-2	.255
-013B	RG-62	.255
-014	8212, BELDEN	.255
-015	730A, LUCENT	.290
-015A	RG-71	.290
-016	724, LUCENT 8281, BELDEN	.324
-017	RG-6	.344
-018	9268, BELDEN	.255
-019	8279, BELDEN	.255
-020	9248, BELDEN	.290
-021	88240, BELDEN	.213
-022	88241, 88269, BELDEN	.255
-023	89108, BELDEN	.255
-024	89120, BELDEN	.290
-025	734A, LUCENT	.255
-026	735A, LUCENT	.178
-027	KS19224L2, LUCENT	.178

# COAX "F" CONNECTORS, 130 SERIES

PART NO	BOARD THICKNESS
CBPLE130-1	.060 - .064
CBPLE130-2	.028 - .033
CBPLE130-3	.090 - .094

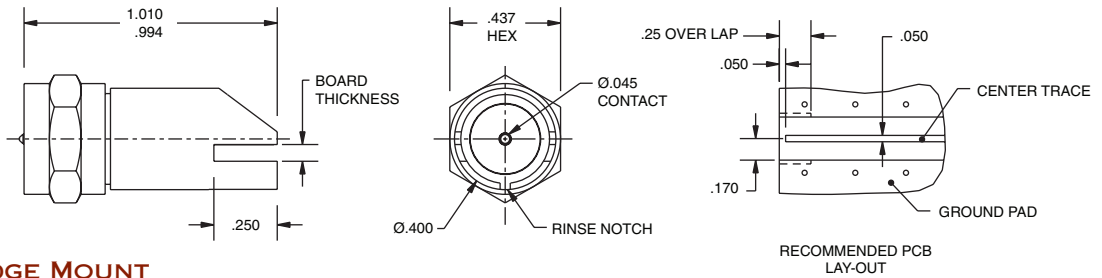

**CIRCUIT BOARD EDGE MOUNT  
"F" STYLE MALE PLUG      CBPLE130-1,-2, or -3**

PART NO	BOARD THICKNESS
CBJE130-1	.060 - .064
CBJE130-2	.028 - .033
CBJE130-3	.090 - .094

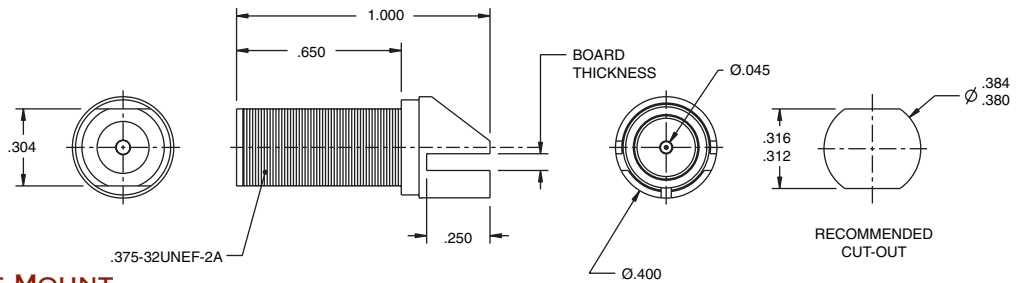

**CIRCUIT BOARD EDGE MOUNT  
"F" STYLE FEMALE JACK      CBJE130-1, -2, or -3**

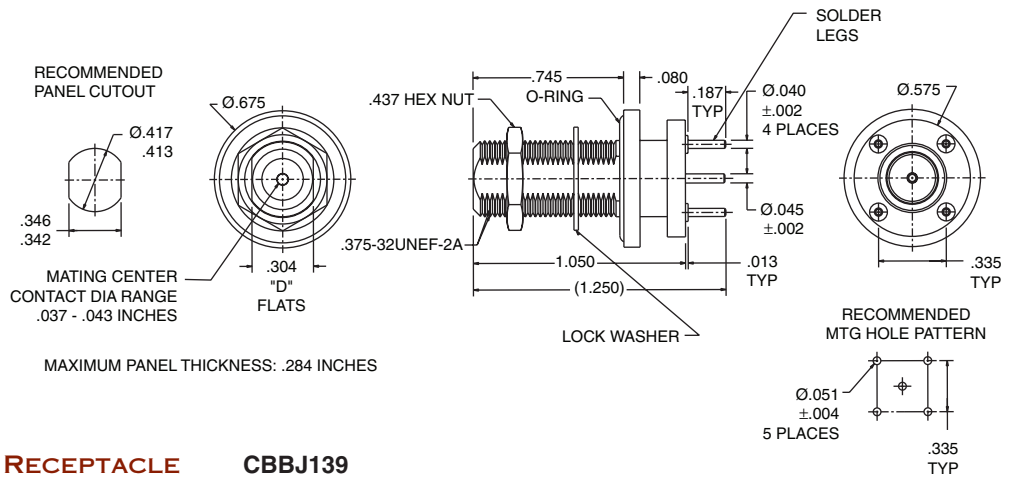

**"F" SERIES, BULKHEAD,  
CIRCUIT BOARD MOUNT RECEPTACLE      CBBJ139**

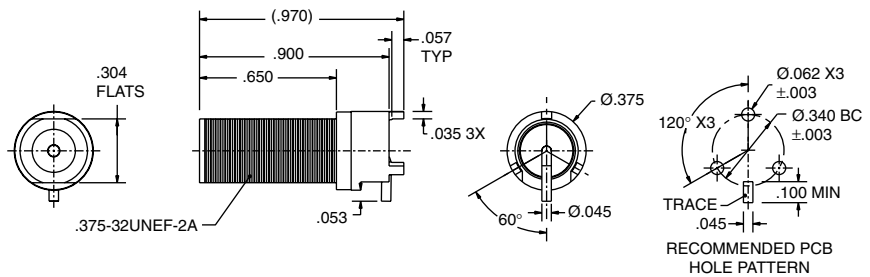

**"F" SERIES 3-POST CIRCUIT  
BOARD MOUNT RECEPTACLE  
WITH SPECIAL RIGHT ANGLE  
CONTACT      105-2137**



## Low VSWR Connectors

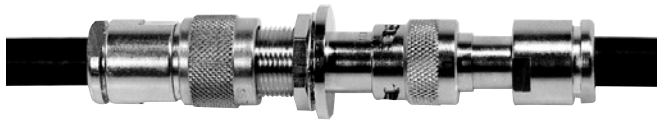

"N" Plug    Patch Jack    Patch Plug

Trompeter's 50Ω low VSWR (1.11:1) patching system has been developed for use at frequencies up to 3GHz and at power levels up to 500 watts. J94 jack accepts a "N" male plug in back and the PL93 or PL94 in the front of the panels shown, or a custom panel of your own design. Patch plugs incorporate a push-fit design that snap into position in the jack and are available with, or without a bayonet locking feature. Normal jack spacing is 3" center-to-center. For a minimum bend radius when patching adjacent jacks, use Trompeter standard patch cords made with RG8 cable with a minimum length of 14". Otherwise the minimum length is 18". Panels loaded at no additional cost.

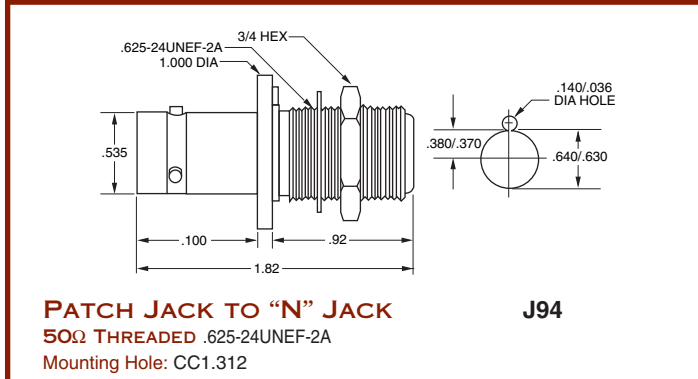
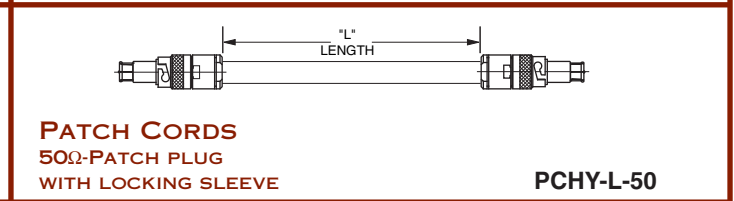
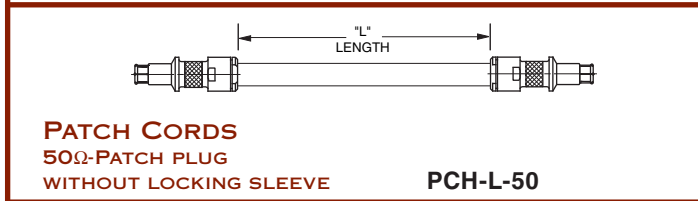
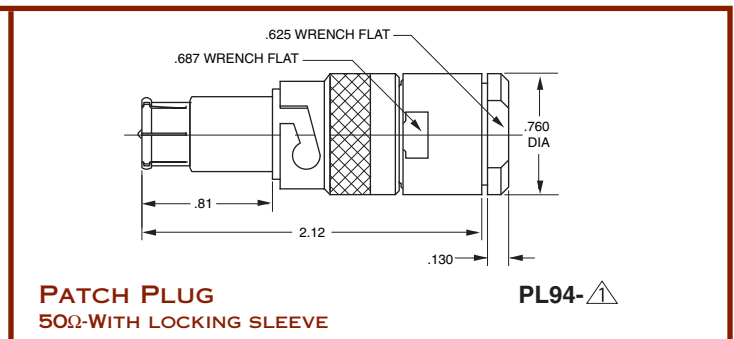
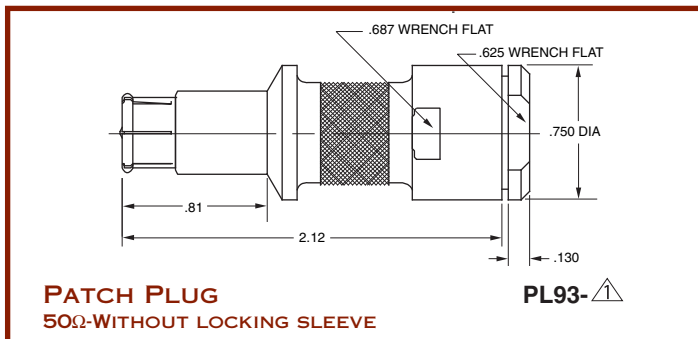

**PANELS FOR J94**

# of Holes	Notching	Panel Type	Height	Part#
12	Open	Common Ground	A = 1.75"	<b>JSH-12</b>
12	Closed	Insulated	A = 1.75"	<b>JSHI-12</b>
24	Open	Common Ground	B = 5.25"	<b>JSH-24</b>
24	Closed	Insulated	B = 5.25"	<b>JSHI-24</b>

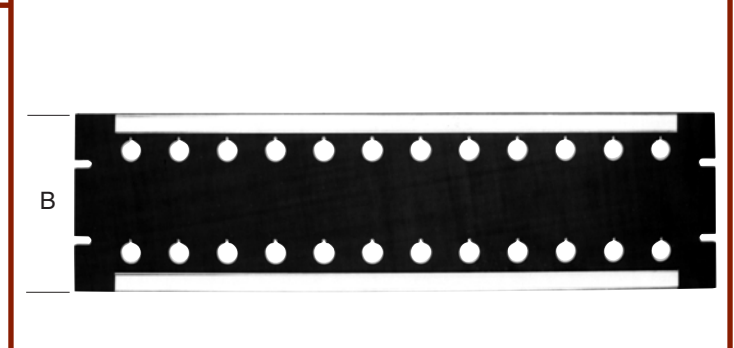
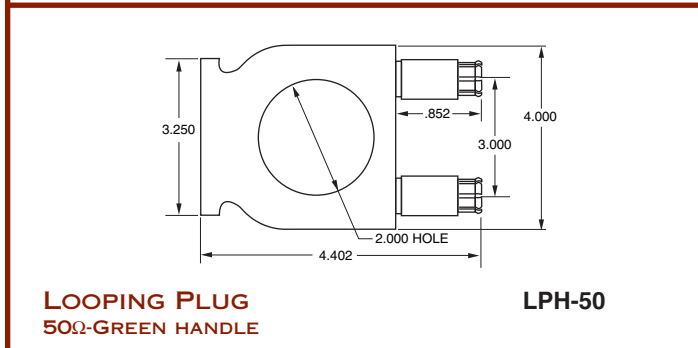

"L" replace with length in inches. Refers to Cable Group Table, see pages 82-124. "D" mounting hole, page 63. For standard panels see pages 60-63.

# 50Ω SUB-MINIATURE COAX 50/350 SERIES, TPS/TCM JACKS & PLUGS

△ Refers to Cable Group Table, see pages 82-124.  
"D" mounting holes are on page 63.

PL50-1 Shown

<b>CABLE PLUG</b>	50Ω	3-lug	<b>PL50-</b> △
<b>WRENCH CRIMP</b>	50Ω	4-lug	<b>PL50FL-</b> △
	50Ω	Threaded	<b>PL350-</b> △

<b>BULKHEAD JACK</b>	50Ω	3-lug	<b>BJ50</b>
<b>FRONT MOUNT, SOLDER POT</b>	50Ω	4-lug	<b>BJ50FL</b>
	50Ω	Threaded	<b>BJ350</b>

Mounting Hole: D6.218

PL50C-001 Shown

<b>CABLE PLUG</b>	75Ω	3-lug	<b>PL50C-</b> △
<b>TOOL CRIMP</b>	50Ω	3-lug	<b>PL50CFL-</b> △
	50Ω	4-lug	<b>PL350C-</b> △
	50Ω	Threaded	

BJ57 Shown

<b>INSULATED BULKHEAD JACK</b>			
<b>FRONT MOUNT, SOLDER POT</b>	50Ω	3-lug	<b>BJ57</b>
	50Ω	4-lug	<b>BJ57FL</b>
	50Ω	Threaded	<b>BJ357</b>

Mounting Hole: D4.187

PL53-1 Shown

<b>PUSH-ON PLUG</b>	50Ω	3-lug	<b>PL53-</b> △
<b>WRENCH CRIMP, TPS/TCM</b>			

<b>TPS PUSH-ON</b>	50Ω		<b>BJ51</b>
<b>SOLDER POT PANEL JACK</b>			
Max Panel Thk: .088	50Ω	Ground Lug	<b>BJ51GL</b>

CJ50-1 Shown

<b>CABLE JACK</b>	50Ω	3-lug	<b>CJ50-</b> △
<b>WRENCH CRIMP</b>	50Ω	4-lug	<b>CJ50FL-</b> △
	50Ω	Threaded	<b>CJ350-</b> △

BJ58 Shown

<b>FEED-THRU JACK</b>			
	50Ω	3-lug	<b>BJ58</b>
	50Ω	4-lug	<b>BJ58FL</b>
	50Ω	Threaded	<b>BJ358</b>

Mounting Hole: D5.190 / D4.190 (Threaded)

<b>CIRCUIT BOARD JACK</b>			
	50Ω	3-lug	<b>CBJ50</b>
	50Ω	4-lug	<b>CBJ50FL</b>
	50Ω	Threaded	<b>CBJ350</b>

BJ59-1 Shown

<b>BULKHEAD JACK</b>	50Ω	3-lug	<b>BJ59-</b> △
<b>WRENCH CRIMP</b>	50Ω	4-lug	<b>BJ59FL-</b> △
	50Ω	Threaded	<b>BJ359-</b> △

Mounting Hole: D4.187

## HIGH FREQUENCY VIDEO PATCHING

Trompeter's new HDVDP and HDVDPM Patch Jacks are designed and engineered to exceed SMPTE 292M specifications for high definition video transmission and connectivity.

The normal-thru contact interface design of HDVDP/HDVDPM consists of a self-aligning normal-thru U-slot, two redundant points of contact, an independent applied normal force at each contact point, and a mechanical wipe region at each contact interface location. These design attributes provide reliable and repeatable patching/un-patching, resulting in low-level contact resistance stability.

### TOP VIEW OF NORMAL-THRU CONTACT INTERFACE (2X)

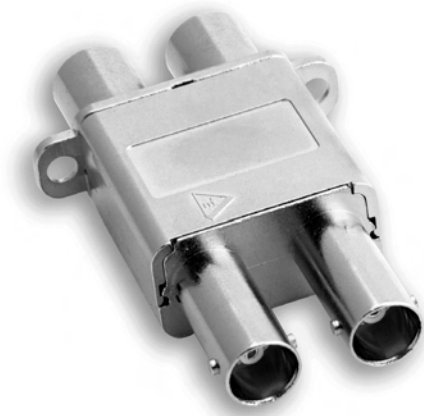
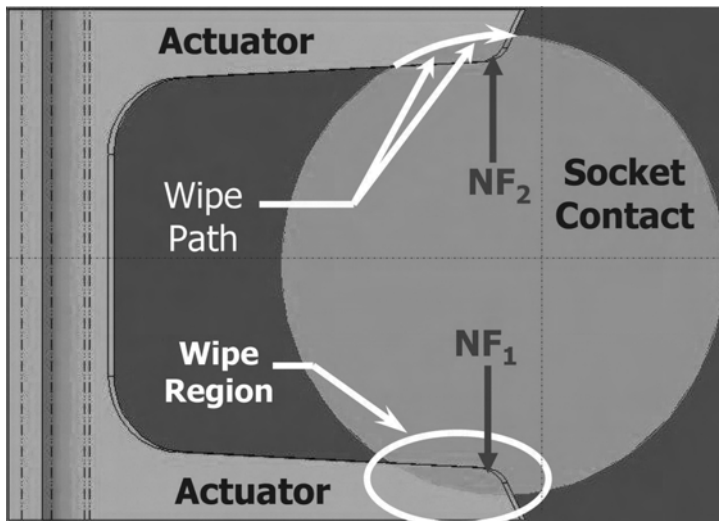

**FULL SIZE PATCH-JACK**  
75Ω TERMINATED & NON-TERMINATED



**MINI PATCH-JACK**  
75Ω TERMINATED & NON-TERMINATED

### HDVDP/HDVDPM Key Features

- Light weight design:
  - HDVDPT (full size): 48.05 grams
  - HDVDPM (mini): 32.1 grams
- High-reliability normal-thru contact design
- Self-wiping normal thru contact design
- Streamlined design for repeatable manufacturability

<b>HDVDPT</b>	Full-size WECO format, terminated
<b>HDVDP</b>	Full-size WECO format, non-terminated
<b>HDVDPMT</b>	mini WECO format, terminated
<b>HDVDPM</b>	mini WECO format, non-terminated

# HIGH FREQUENCY VIDEO PATCHING

## SMPT E 292M REQUIREMENTS

Parameter	HD (SMPT E 292)	SD (SMPT E 259)	Comments
Connection Medium	Coaxial Cable	Coaxial Cable	75 ohm, low loss, double shielded
Connector Type	BNC	BNC	75 ohm version
Cable Length	80 meters	300 meters	Depending on cable type
Bit rate	1.485 Gbps	270 Mbps	145.5 MHz word clock x 10 27 MHz work clock x 10
Return Loss	-15 dB or better @ 5 MHz to 1.485 GHz	-15 dB or better @ 5 MHz to 1.485 GHz	Nominal into 75 ohm termination
Voltage Levels	800 mV P-P +/- 10%	800 mV P-P +/- 10%	Nominal into 75 ohm termination
Jitter	<0.2 UI or <134.68 pS	<0.2 UI or <134.68 pS	HD UI = 673.4 pS SD UI = 3.7 nS
DC offset	0.0 V +/- 0.5 V	0.0 V +/- 0.5 V	Nominal at mid-amplitude
Rise/fall times	<270 pS, <100 pS diff.	<270 pS, <100 pS diff.	20% - 80%

## HDVDP/HDVDP M PERFORMANCE VS. SMPT E 292 REQUIREMENTS

Parameter	SMPT E 292M	HDVDP M T (mini)	HDVDP T (full size)
Return Loss (s1, 1)	-15 dB or better @ 5 MHz to 1.485 GHz	-30.67 dB	-31.03 dB
Voltage Levels	800 mV P-P +/- 10%	760 mV	760 mV
Jitter	<0.2 UI or <134.68 pS @ 1.485 Gbps	.082 UI or 55 pS	.082 UI or 55 pS
Rise/fall times	<270 pS, rRft <100 pS @ 1.485 Gbps	RT = 220 pS FT = 200 pS rRFT = 30 pS	RT = 220 pS FT = 200 pS rRFT = 30 pS

**Typical  
Time-Domain Eye  
Pattern**

**Full Size and  
Mini Patch-Jacks**

Jitter & Rise Time  
measures shown in  
above table

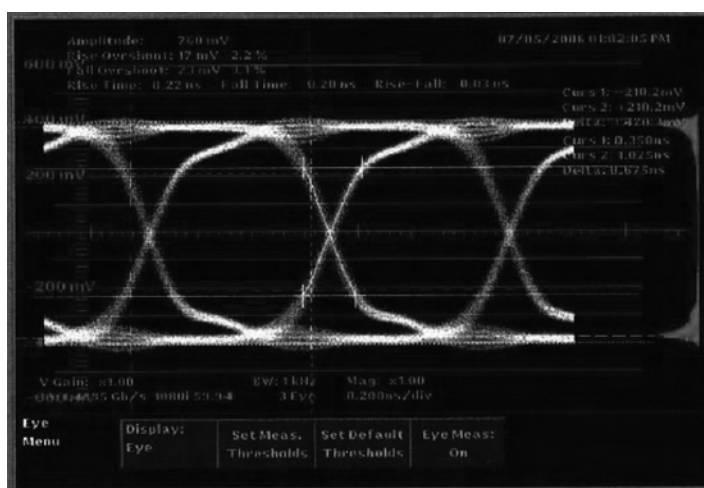

## HIGH FREQUENCY VIDEO PATCHING

The J315MW is superior quality, high bandwidth, dual video patch jack. This low profile, high performance component is designed for HDTV digital applications where space allocation is critical, such as in video truck application. It is ideal for situations where self-normalling is not practical, usually due to environmental considerations such as high ambient airborne particles or high vibration.

When used in conjunction with the LPMWHF looping plug, a “normal-thru” circuit is achieved, which will pass the full 1.485 Gbps of uncompressed data (2.25GHz of frequency) needed for HDTV, with return loss performance which exceeds SMPTE292M requirements. This high performance is maintained when patching from one location to another, using the PCMWB-L patch cord (call factory).

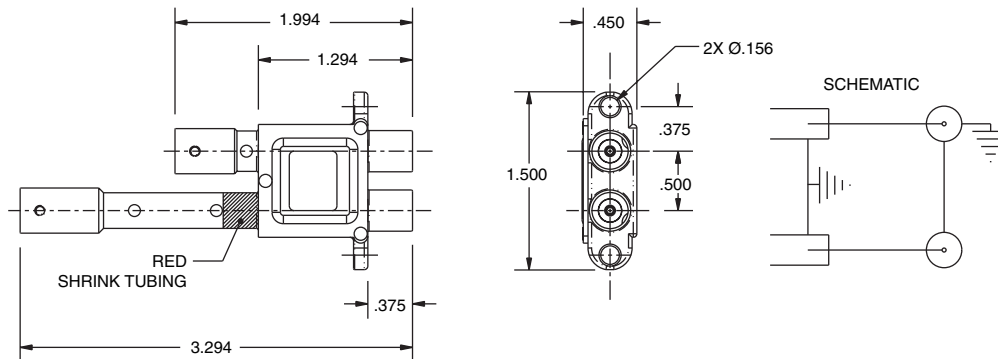

HDTV Ready High Frequency 75 Ohm Dual Coaxial Mini-WECo Patch Jack with BNC Receptacles

Un-Terminated **J315MW**

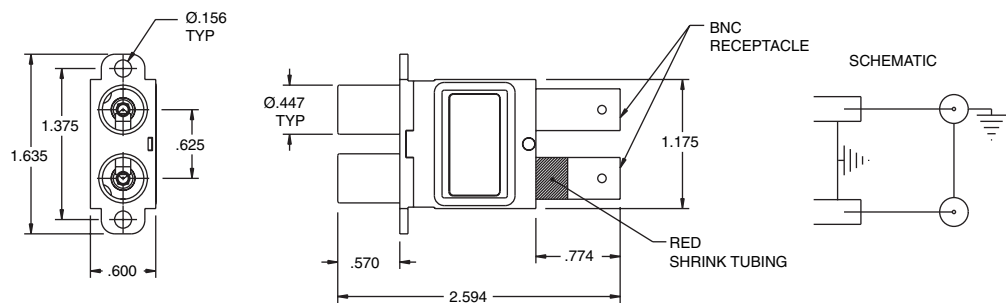

HDTV Ready High Frequency 75 Ohm Dual Coaxial WECo Patch Jack with BNC Receptacles

Un-Terminated **J315W**

Coaxial Video Monitor Probe  
**BNC JACK MP20W**

Monitors HDVDP, J314, J214 and J14 Series without interruption of normal-thru signal.

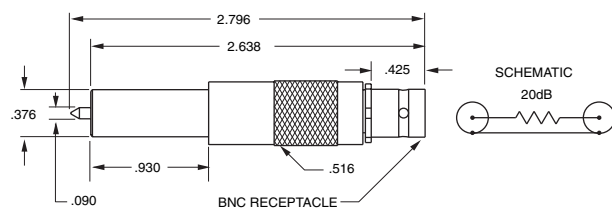

# STANDARD COAX PATCH JACKS

Patch Jacks J15, J14, J24, J314, and HDVDP can be mounted vertically or horizontally on 5/8" centers. Mounting tabs are normally "back-to-back" as shown. For side-by-side tabs for horizontal mounting, add the letter "L" for left-hand tabs or "R" for right hand tabs (not available on J24, J214, J314, and HDVDP).

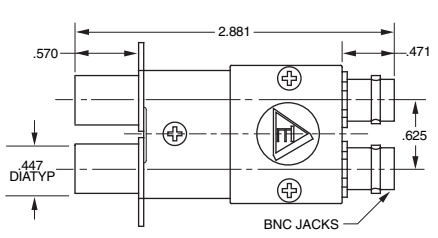
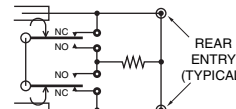
**TERMINATED:**  
PROVIDES A RESISTIVE LOAD TO THE UNUSED SIDE. INSERTING A PLUG INTO THE THE SOURCE SIDE AUTOMATICALLY TERMINATES THE LOAD SIDE. INSERTION INTO THE LOAD SIDE AUTOMATICALLY TERMINATES THE SOURCE SIDE.

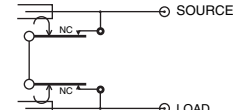

**UN-TERMINATED:**  
INSERTING A PLUG INTO EITHER SIDE BREAKS THE NORMAL-THRU.

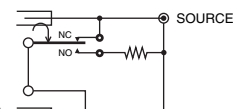

**MONITOR-TERMINATED:**  
INSERTING A PLUG INTO THE SOURCE SIDE PROVIDES A RESISTIVE LOAD TO THE LOAD SIDE. INSERTION INTO THE LOAD SIDE MONITORS THE NORMAL-THRU SIGNAL ONLY.

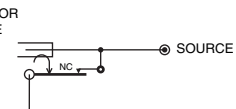





**MONITOR:**  
INSERTING A PLUG INTO THE SOURCE SIDE BREAKS THE NORMAL-THRU. INSERTION INTO THE LOAD SIDE MONITORS THE NORMAL-THRU SIGNAL ONLY.

**SCHEMATICS**

### J14 SERIES

**50Ω RCA STANDARD**

Rear Entry	Configuration	Center-pin	Part#
BNC	Unterminated	.070"	<b>J14</b>
BNC	Terminated	.070"	<b>J14T-R</b>
BNC	Monitor	.070"	<b>J14M</b>
BNC	Monitor-Terminated	.070"	<b>J14MT-R</b>
TNC	Unterminated	.070"	<b>J14H</b>
TNC	Terminated	.070"	<b>J14HT-R</b>
TNC	Monitor	.070"	<b>J14MH</b>
TNC	Monitor-Terminated	.070"	<b>J14MHT-R</b>
Cable Crimp	Unterminated	.070"	<b>J14C-</b>
Cable Crimp	Terminated	.070"	<b>J14CT-R-</b>
Cable Crimp	Monitor	.070"	<b>J14MC-</b>
Cable Crimp	Monitor-Terminated	.070"	<b>J14MCT-R-</b>

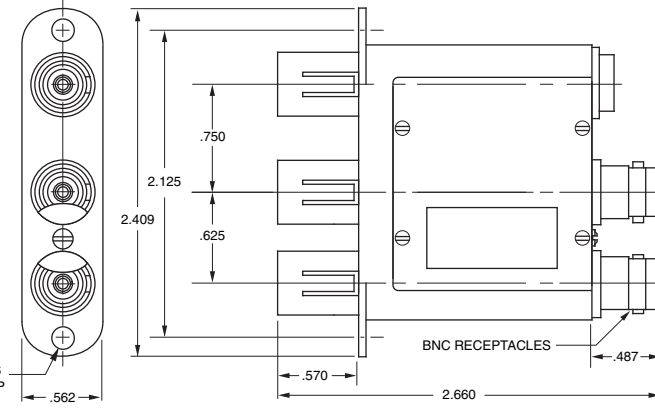

**HIGH FREQUENCY  
NORMAL-THRU  
WITH MONITOR  
DUAL COAX PATCH JACK**

*To be used with grey aluminum insulated panel..JIS-72 (see page 54).*

**J24WMSTHF-75**

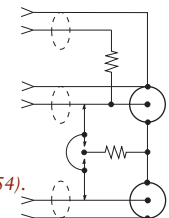

**SCHEMATIC**

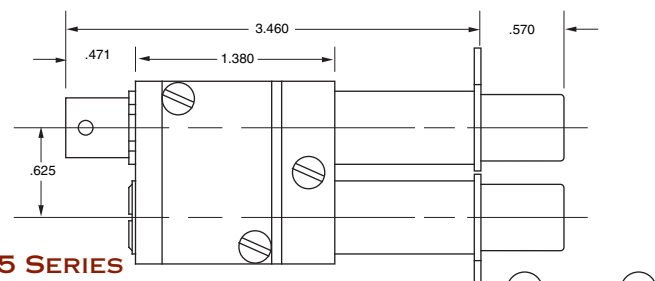

**J15 SERIES  
CABLE REAR ENTRY**

Normally one BNC or TNC rear entry connection.

REAR ENTRY	PREWIRED?	CENTER PIN	50Ω RCA
BNC Single	Y	.070"	<b>J15B</b>
BNC Single	N	.070"	<b>J15BA</b>
BNC Dual	Y	.070"	<b>J15BB</b>
BNC Dual	N	.070"	<b>J15BBA</b>
TNC Single	Y	.070"	<b>J15H</b>
TNC Single	N	.070"	<b>J15HA</b>
TNC Dual	Y	.070"	<b>J15HH</b>
TNC Dual	N	.070"	<b>J15HHA</b>
Cable Single	N	.070"	<b>J15-</b>

REAR ENTRY	PREWIRED?	CENTER PIN	75Ω WE
BNC Single	Y	.090"	<b>J15WB</b>
BNC Single	N	.090"	<b>J15WBA</b>
BNC Dual	Y	.090"	<b>J15WBB</b>
BNC Dual	N	.090"	<b>J15WBBA</b>
TNC Single	Y	.090"	<b>J15WH</b>
TNC Single	N	.090"	<b>J15WHA</b>
TNC Dual	Y	.090"	<b>J15WHH</b>
TNC Dual	N	.090"	<b>J15WHHA</b>
Cable Single	N	.090"	<b>J15W-</b>

 Refers to the Cable Group Table, see pages 82-124. Standard Panels see pages 46-49. R-Resistance (1/2W, 1%)

## COAX PATCHING ACCESSORIES

### ADAPTERS

**FIXED PARALLELING** 50Ω BNCs

*Call factory for 75Ω versions.*

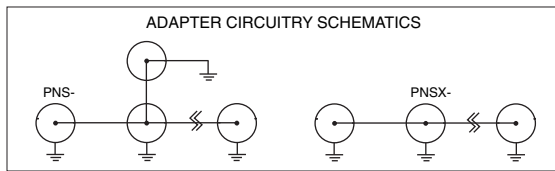
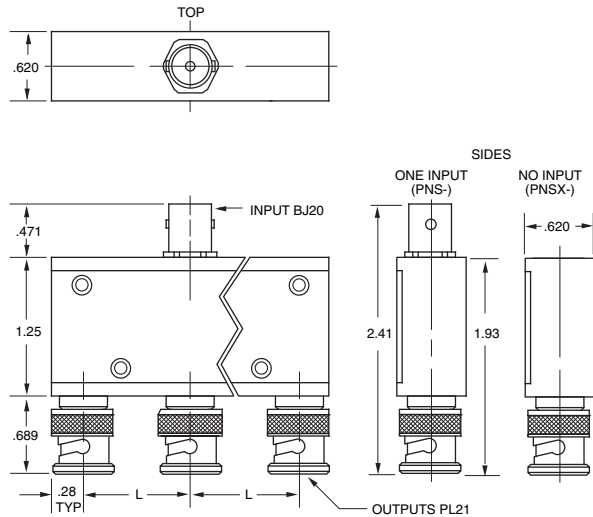

$\triangle$  = NUMBER OF CONNECTORS

"L"	ONE INPUT	NO INPUT
0.625"	PNS-B- $\triangle$	PNSX-B- $\triangle$
0.750"	PNS-C- $\triangle$	PNSX-C- $\triangle$
0.830"	PNS-D- $\triangle$	PNSX-D- $\triangle$
0.875"	PNS-E- $\triangle$	PNSX-E- $\triangle$
1.000"	PNS-F- $\triangle$	PNSX-F- $\triangle$
1.125"	PNS-G- $\triangle$	PNSX-G- $\triangle$
1.210"	PNS-H- $\triangle$	PNSX-H- $\triangle$
1.250"	PNS-J- $\triangle$	PNSX-J- $\triangle$
1.430"	PNS-K- $\triangle$	PNSX-K- $\triangle$
.0734"	PNS-L- $\triangle$	PNSX-L- $\triangle$

"L" Length in inches  
Also available with push-on connectors, call factory.

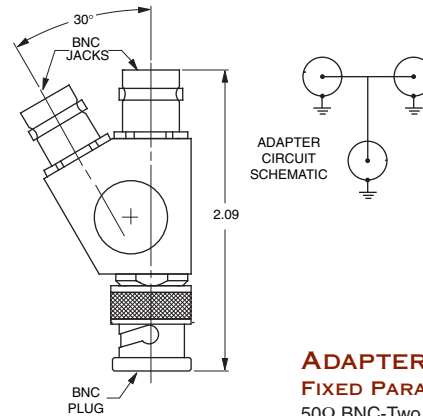

**ADAPTER**  
**FIXED PARALLELING**  
50Ω BNC-Two jacks, One plug **PN2C**

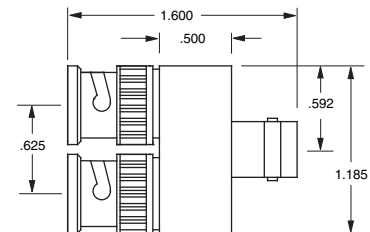

**ADAPTER**  
**FIXED PARALLELING**  
50Ω BNC-One jack, Two plugs **PN2**

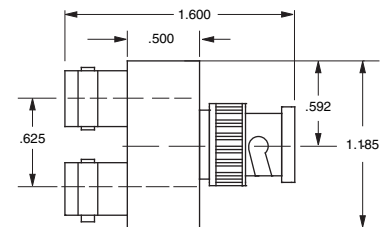

**ADAPTER**  
**FIXED PARALLELING**  
50Ω BNC-Two jacks, one plug **PN2A**

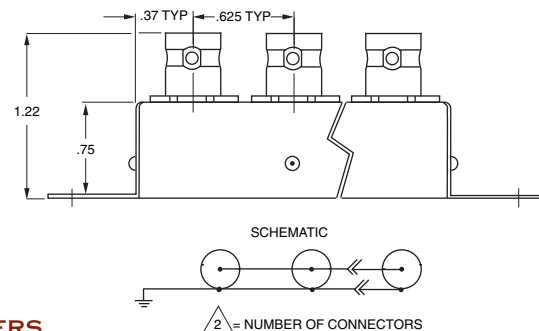

**ADAPTERS**  
**MULTIPLE PARALLEL NETWORK**  
50Ω **MPN- $\triangle$  /BNC**  
50Ω **MPN- $\triangle$  /TNC**  
*Contact the factory for more information.*



# COAX PATCH JACKS

<p>J3W Shown</p> <p><b>PATCH JACK</b> <b>BNC REAR INTERFACE</b></p> <p>50Ω RCA Center pin-.070" 75Ω WE Center pin-.090"</p> <p><b>J3</b> <b>J3W</b></p>	<p><b>PATCH JACK</b> <b>"N"</b></p> <p>50Ω "N", RCA Center pin-.070" 75Ω "N", WE Center pin-.090"</p> <p><b>J9</b> <b>UJ9W</b></p> <p>Minimum vertical/horizontal centers .875"</p>
<p><b>PATCH JACK</b> <b>CRIMP</b></p> <p>50Ω RCA Center pin-.070" 75Ω WE Center pin-.090"</p> <p><b>J3C-</b> <b>J3CW-</b></p> <p>Microswitch not available.</p>	<p><b>PATCH JACK</b> <b>BNC</b></p> <p>50Ω RCA Center pin-.070" 75Ω WE Center pin-.090"</p> <p><b>J10</b> <b>J10W</b></p> <p>Requires special threaded panel .5-28 UNEF-2A. Contact Factory when ordering panels.</p>
<p><b>PATCH JACK</b> <b>SOLDER POT</b></p> <p>50Ω RCA Center pin-.070" 75Ω WE Center pin-.090"</p> <p><b>J3D</b> <b>J3WD</b></p> <p>(WECo 468 type)</p>	<p><b>PATCH JACK</b> <b>TNC</b></p> <p>50Ω RCA Center pin-.070" 75Ω WE Center pin-.090"</p> <p><b>J5</b> <b>J5W</b></p>
<p>J3E-1 Shown</p> <p><b>PATCH JACK</b> <b>CABLE ENTRY</b></p> <p>50Ω RCA Center pin-.070" 75Ω WE Center pin-.090"</p> <p><b>J3E-</b> <b>J3WE-</b></p> <p>(WECo 447 type) Microswitch not available</p>	<p><b>PATCH JACK</b> <b>SELF-TERMINATING</b></p> <p>BNC 50Ω RCA Center pin-.070" BNC 75Ω WE Center pin-.090" (WECo 477B type) TNC 50Ω TNC 75Ω</p> <p><b>J13-R</b> <b>J13W-R</b> <b>J13H-R</b> <b>J13WH-R</b></p>
<p><b>BNC</b> <b>PATCH JACK</b></p> <p>50Ω RCA Center pin-.070" 75Ω WE Center pin-.090"</p> <p><b>J3A</b> <b>J3WA</b></p> <p>External SPDT Microswitch (125-250 VAC, 5 amps/28 VDC, 1amp res, 3 amp. ind)</p>	<p><b>PATCH JACK</b> <b>SELF-TERMINATING</b></p> <p>50Ω RCA Center pin-.070" 75Ω WE Center pin-.090"</p> <p><b>J13C-R-</b> <b>J13WC-R-</b></p> <p>Cable crimp: Circuit is terminated when plug is removed.</p>

△ Refers to the Cable Group Table, see pages 82-124. Standard Panels see pages 46-49. R = Resistance

## STANDARD & MINI-WECO COAX PATCH PLUGS

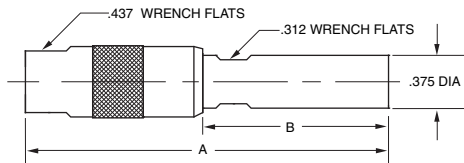

### PATCH PLUG

**SHIELD CRIMP** 50Ω RCA Center pin .070" A=2.73" B=1.50"  
75Ω WE Center pin .090" A=2.45" B=1.22"

(WECO 358 type)

**PL1C-**   
**PL1WC-**

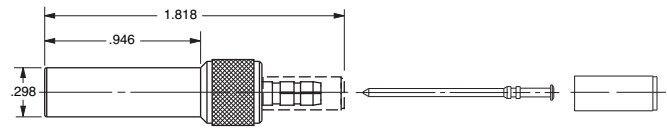

### PATCH PLUG

**STANDARD BNC STRIP DIMENSION**  
**CRIMP CONTACT, CRIMP SHIELD**

(WECO 440 Type)

**PL11SC-**

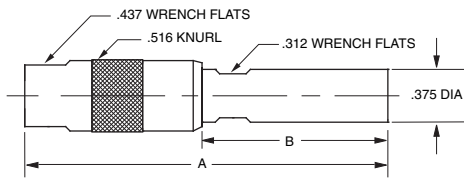

### PATCH PLUG

### CABLE ENTRY, FIELD SERVICEABLE

For RG58 50Ω RCA Center pin .070" A=2.80" B=1.568" ..... **PL1**  
For RG59 50Ω RCA Center pin .070" A=2.737" B=1.505" ..... **PL2**  
For RG58 75Ω WE Center pin .090" A=2.52" B=1.288" ..... **PL1W**  
For RG59 75Ω WE Center pin .090" A=2.457" B=1.225" ..... **PL2W**

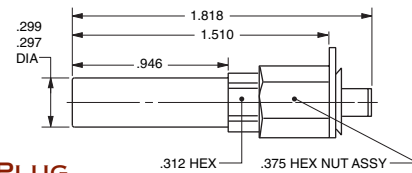

### PATCH PLUG

**STANDARD CRIMP PLUG**  
**WITH LOCKING TAB**

(WECO 440 Type)

**PL11SCLT-**

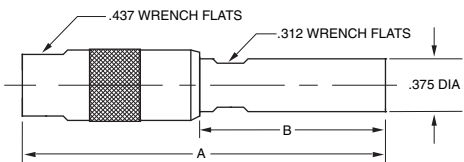

### TERMINATION PLUG

**NO CHAIN**

50Ω RCA Center pin .070" A=2.81" B=1.58" **TP-1-R**

**NO CHAIN**

75Ω WE Center pin .090" A=2.45" B=1.25" **TPW-1-R**

For other chain options, see page 45. (WECO 340C type)

A=2.81" B=1.58"

**TP-1-R**

A=2.45" B=1.25"

**TPW-1-R**

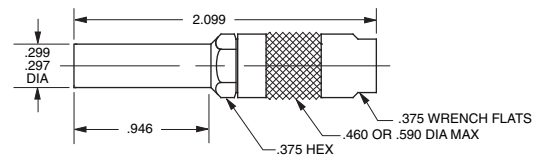

### PATCH PLUG

**SOLDER CONTACT, CRIMP SHIELD**

(WECO 440 Type)

**PL11C-**

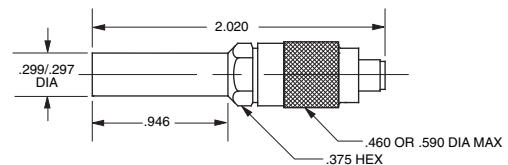

### PATCH PLUG

**CRIMP CONTACT, CRIMP SHIELD**

(WECO 440 Type)

**PL11AC-**

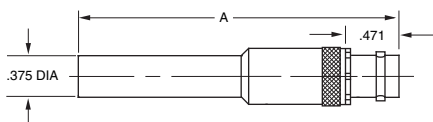

### ADAPTERS

### PATCH PLUG TO BNC/TNC

50Ω RCA plug Center pin .070" 50Ω BNC A = 2.774" ..... **AD1**

50Ω RCA plug Center pin .070" 50Ω TNC A = 2.774" ..... **ADH1**

75Ω WE Center pin .090" 75Ω BNC A = 2.83" ..... **AD1W**

75Ω WE Center pin .090" 75Ω BNC A = 1.93" ..... **AD1WH**

75Ω WE Center pin .090" 75Ω TNC A = 2.83" ..... **ADH1W**

(WECO 358 type) .....

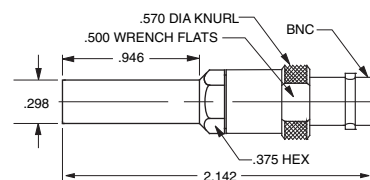

### ADAPTER

**75Ω MINATURE PATCH PLUG (MINI-WECO TYPE)**  
**TO 75Ω BNC**

**ADMW12**

Refers to the Cable Group Table, see pages 82-124. **R** = Resistance

# 75Ω MINI-WECO Coax Patch Jacks

	A	B	C
J11B	.264	.295	.638
J11MW	.375	.375	.728

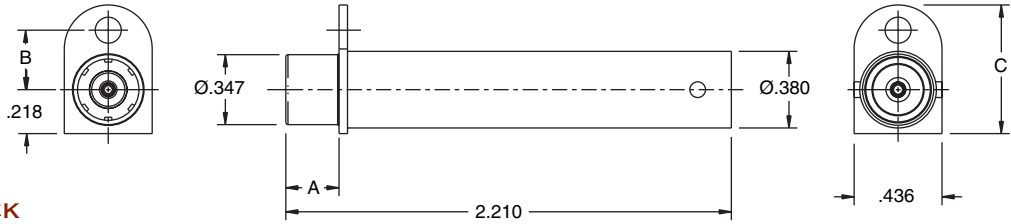

**MINIATURE PATCH JACK**  
MINI-WECO TYPE  
BNC REAR INTERFACE

**J11MW**

	A	B	C
J11BL	.264	.295	.638
J11MWL	.375	.375	.728

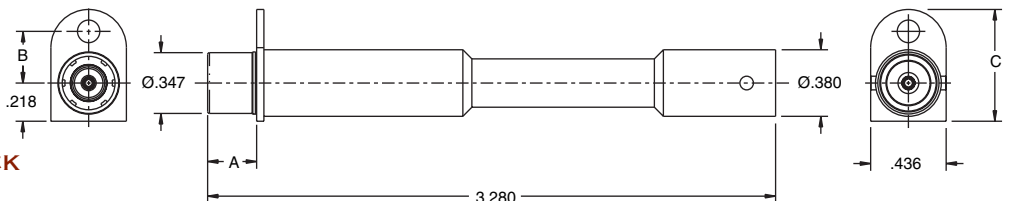

**MINIATURE PATCH JACK**  
MINI-WECO TYPE  
BNC REAR INTERFACE

**J11MWL**

PL1MWLT-(DASH NO)

DASH NO	CABLE ACCOMMODATED	A HEX
-009	8218, BELDEN 21-597, ESSEX YR23023, BELDEN	.178
-013A	TCC-75-2, TROMPETER 8241F, BELDEN	.255
-014	8212, BELDEN	.255
-025	734A TYPE	.255
-026	735A TYPE	.178
-027	KS19224L2 LUCENT	.178

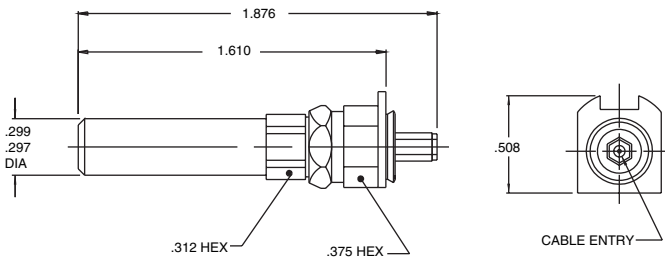

**PATCH PLUG**  
MINI-WECO CRIMP PLUG  
WITH LOCKING TAB

**PL1MWLT-⚠**

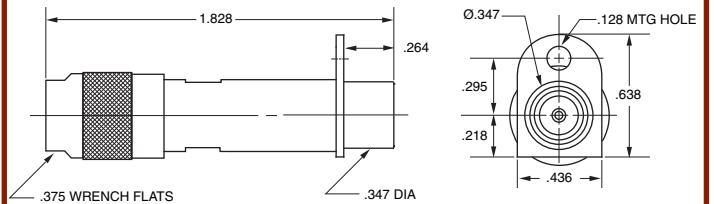

**MINIATURE PATCH JACK**  
CABLE ENTRY, FIELD SERVICEABLE MINI-WECO TYPE  
Minimum .64" centers

**J12-⚠**

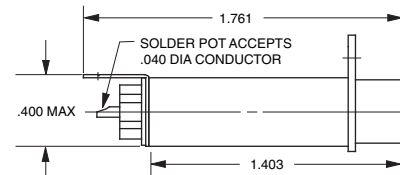

**MINIATURE PATCH JACK**  
SOLDER POT, MINI-WECO TYPE

**J11D**

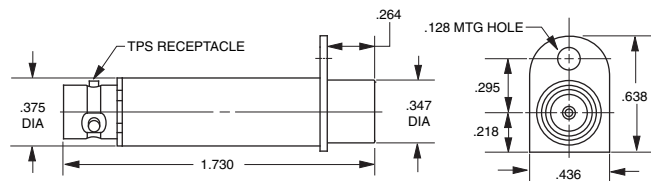

**MINIATURE PATCH JACK**  
TPS, MINI WECO TYPE

**J11**

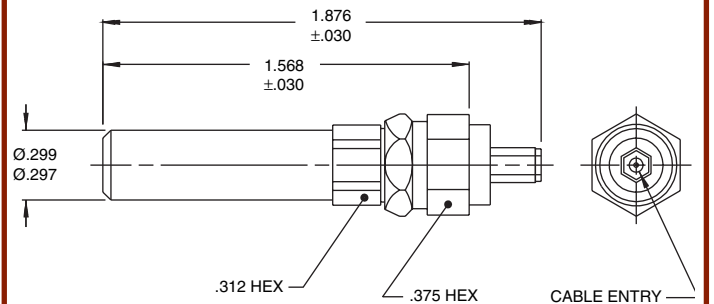

**PATCH PLUG**  
MINI-WECO BNC STRIP DIMENSION  
CRIMP CONTACT, CRIMP SHIELD

**PL1MW-⚠**

⚠ Refers to the Cable Group Table, see pages 82-124.

## AUDIO PATCHING, STANDARD COAX PATCHING & LOOPING PLUGS

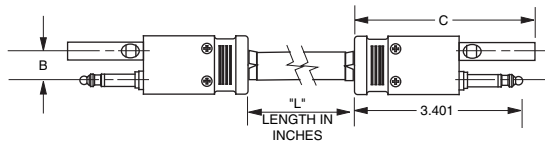

### AUDIO/VIDEO PATCH CORD

VIOLET, 75Ω WE, .090" CENTER PIN

<b>AVPCW-L-75</b>	<b>AVPC-L-50</b>	B = .625	C = 3.485
<b>AVPCLW-L-75</b>	<b>AVPCL-L-50</b>	B = 1.000	C = 3.765

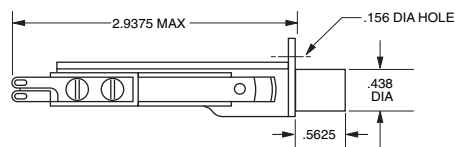

### SINGLE AUDIO JACK

3 CIRCUIT NORMALING  
JJO-42 TYPE

**M641/3-2**

### Standard Coax Looping Plugs

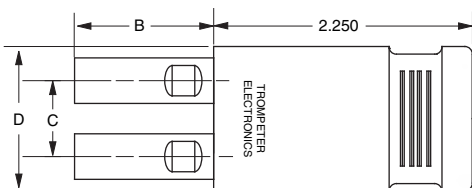

Plain Handle Shown

### LOOPING PLUGS

Handle: B=1.51" C=.625" D=1.20"	Center Pin	50Ω RCA
PLAIN	.070"	LP-Z
PINCH	.070"	LPP-Z
TEST POINT SINGLE	.070"	LP2TP-Z
TEST POINT DUAL	.070"	LPA-Z
BNC MONITOR	.070"	

Handle: B=1.51" C=1.00" D=1.57"	Center Pin	50Ω RCA
PLAIN	.070"	LPL-Z
TEST POINT SINGLE	.070"	LPLTP-Z
BNC MONITOR	.070"	LPLA-Z

Handle: B=1.25" C=.625" D=1.20"	Center Pin	75Ω WE
PLAIN	.090"	LPW-Z
PINCH	.090"	LPPW-Z
TEST POINT SINGLE	.090"	LPWTP-Z
TEST POINT DUAL	.090"	LPW2TP-Z
BNC MONITOR	.090"	LPWA-Z

Handle: B=1.25" C=1.00" D=1.57"	Center Pin	75Ω WE
PLAIN	.090"	LPLW-Z
TEST POINT SINGLE	.090"	LPLWTP-Z
BNC MONITOR	.090"	LPLWA-Z

Handles are color coded:  
Green = 50Ω Violet = 75Ω White = 93Ω

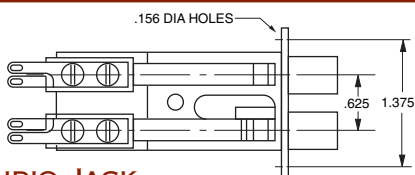

### DUAL AUDIO JACK

3 CIRCUIT NORMALING  
WECO 482A TYPE

**MT389**

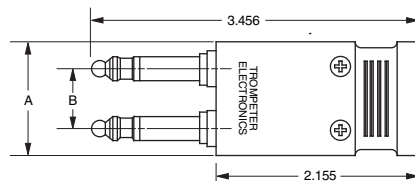

ALP3	A = 1.200	B = .625
ALPL3	A = 1.570	B = 1.000

### LOOPING PLUG

AUDIO (HAIR PIN)  
PLAIN

**ALP3/ALPL3**

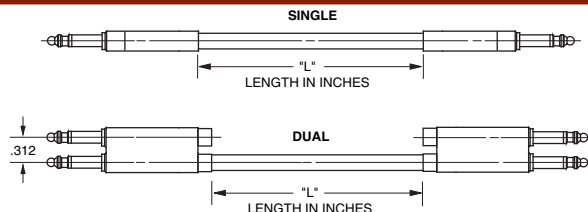

### AUDIO BANTAM PATCH CORDS

SINGLE PLUG **APCB-L**  
DUAL PLUG **APCDB-L**

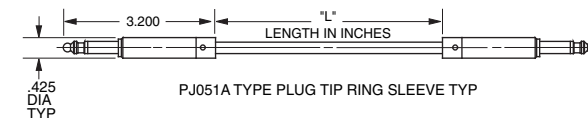

### AUDIO PATCH CORDS

3-CIRCUIT..... SEE TABLE BELOW

AUDIO PATCHCORDS: SPECIFY COLOR WHEN ORDERING: RED, BLACK, YELLOW, GREEN, BLUE, OR PURPLE

COLOR	12"	18"	24"	36"	48"
	APC3-12	APC3-18	APC3-24	APC3-36	APC3-48

Replace "L" with length in inches. For Audio Jack Fields call factory.



## PATCH PRODUCTS/STANDARD PANEL SPECIFICATIONS

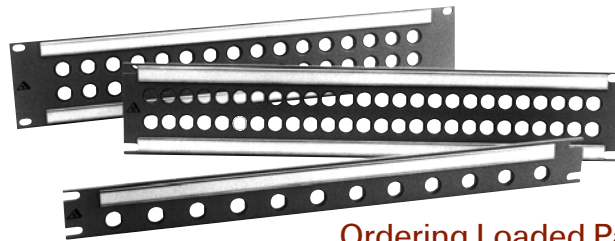

### Trompeter Patch Products

Trompeter offers a wide selection of patching products for military databus, Telemetry, Telecom, Broadcast, CATV, and testing. We offer these products for Twinax, Triax, and Coax cabling and in sizes to meet your space restrictions and environmental requirements.

### Standard 19" Panels

In popular sizes and configurations

Available in insulated black phenolic, and insulated or non-insulated aluminum. Aluminum panels are painted standard gray and come with either a phenolic back bar (insulated type), or an iridited aluminum back bar (non-insulated type). Aluminum panels can be painted to suit, or color matched (*special order*). Phenolic panels are available in black only.

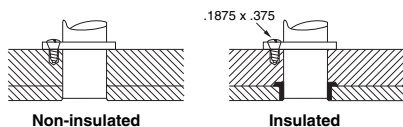

Aluminum Phenolic Nylon Bushing

Panels available in heights of 1.75 inches (1 RU) or 3.5 inches (2 RU).

### Custom Panels & Marking

Custom panels can be configured to meet your specifications, including special wiring, colors, engraving, or silk-screening (custom marking). Patch jack locations can also be marked on the rear of the panel for easy location of jacks. Please contact your local representative, or fax us your requirements using form on page 137.

### Hole Plugs

For jacks and panels

Hole Plugs for:	Hole Diameter	Part Number
Miniature patch panel (J8)	.250"	HP250
Miniature patch jack (HDVDPM, J11)	.304"	HP304
Standard patch jack (HDVDP)	.375"	HP375
Standard patch panel (JS, JSI)	.437"	HP437
Standard patch panel	.500"	HP500



Front Loading Modular Panels are on page 14.

### Ordering Loaded Panels

Panels can be ordered pre-loaded with any compatible jacks *without* additional labor charge by using the following part number format (provided the mechanical restrictions are recognized).

**EXAMPLE:** Standard 48-hole, Non-insulated Panel (JS-48), loaded with twenty four (24) Standard 75Ω Patch Jacks (J214W)

JS(I)(B)(X)-48W / J214W

#### Panel part number

JS: Aluminum panel (Gray)

JSI: Insulated panel (Gray)

JSIB: Insulated panel (Black)

JSIX: Miniature Insulated panel (Black)

#### Number of holes

#### Jack part number

### Panel Specifications

#### Notching

<b>Metal panels</b>	(EIA-310-C)	Open
<b>Phenolic</b>	(EIA-310-C)	Closed

#### Materials

##### JS Series, Common ground panels

Panel	6061-T6 grade aluminum
Backbar	6061-T6 grade aluminum

##### JSI Series, Insulated panels

Panel	6061-T6 grade aluminum
Backbar	XXX non-hydroscopic phenolic
Jack insulation	Nylon sleeves

#### Finishes

<b>Standard Finish</b>	FED-STD-595-26307, Light Gray
<b>Customer Supplied</b>	FED-STD-595# or paint chip
<b>Chemical Film Finish</b>	MIL-C-5541, Class 1a (Gold tone) MIL-C-5541, Class 3, (Clear)

#### Identification

<b>Designation Strip</b>	Passivated steel
Standard patch panels	DS1 .580" x 16.6"
Standard patch panels	DS2 .870" x 16.6"
High density patch panels	DS4 .240" x 16.6"
<b>Card</b>	Opaque vinyl
<b>Window</b>	Clear vinyl

#### Modification Kit

19" panels can be modified for use in 23" racks. Call factory and ask for part # 700-0408.

# CABLE DISTRIBUTION PANELS

## Distribution Panels



## Ordering Loaded Distribution Panels

### EXAMPLE:

\*JS - 52 D3SF7 / (U)BJ28

Panel type -Table A, Col 2 \_\_\_\_\_  
 Mounting hole -Table B, Col. 1 \_\_\_\_\_  
 Jack Type -Table B, Col. 3/4 ("U" designates 75Ω) \_\_\_\_\_

- \*JS- Non-Insulated Panel ..... (Open notch)
- \*JSI- Insulated panel .....(Closed notch)

The 19" panels listed in Table A below accommodate the bulkhead jacks designated by a "\*" in Panel Columns A- M of Table B to the right. For panel specifications: See page 54

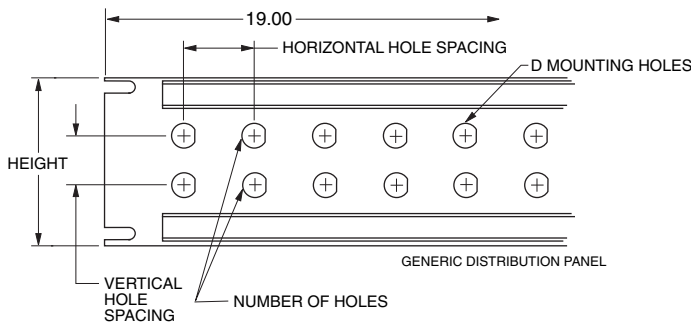

**TABLE A: PANELS**

PANEL COL.	COLUMN 2 PANEL TYPE	# OF HOLES	PANEL HEIGHT	HOLE SPACING HOR.	VERT.
A	JS(I)-5	5	1.75"	2.500"	--
B	JS(I)-8	8	1.75"	2.070"	--
C	JS(I)-10	10	1.75"	1.656"	--
D	JS(I)-12	12	1.75"	1.430"	--
E	JS(I)-14	14	1.75"	1.210"	--
F	JS(I)-16	16	1.75"	1.000"	--
G	JS(I)-20	20	1.75"	0.830"	--
H	JS(I)-24S	24	1.75"	0.723"	--
I	JS(I)-24W	24	3.50"	1.430"	1.000"
J	JS(I)-32	32	3.50"	1.000"	1.000"
K	JS(I)-40	40	3.50"	0.875"	0.875"
L	JS(I)-40W	40	3.50"	0.830"	1.000"
M	JS(I)-52	52	3.50"	0.675"	1.000"
O	JS(I)-24	24	5.20"	1.450"	2.250"

Note: Panels are 19" Insulated or Non-Insulated Standard Gray Aluminum. See chart on the right for loaded panel ordering.

"D" hole specifications are on page 63.

Column 1 Mtg Hole	75 Ω	Column 3 Jacks: 2/3/4 Lug	Column 4 Threaded	Panel Columns												
				A	B	C	D	E	F	G	H	I	J	K	L	M
DD4	U	AD 95		*	*	*	*	*	*	*	*	*	*	*	*	*
DD4	U	AD1 95		*	*	*	*	*	*	*	*	*	*	*	*	*
D 5SF 5	U	BJ 20		*	*	*	*	*	*	*	*	*	*	*	*	*
D 3SF 6	U	BJ 21		*	*	*	*	*	*	*	*	*	*	*	*	*
D 2SF 3	U	BJ 26		*	*	*	*	*	*	*	*	*	*	*	*	*
D 8SF 12	U	BJ 26GF		*	*	*	*	*	*	*	*	*	*	*	*	*
D 3SF 7	U	BJ 27		*	*	*	*	*	*	*	*	*	*	*	*	*
D 3SF 7	U	BJ 28/BJ 24		*	*	*	*	*	*	*	*	*	*	*	*	*
D 8SF 11	U	BJ 28GF		*	*	*	*	*	*	*	*	*	*	*	*	*
D 2SF 3	U	BJ 29-6 Large body		*	*	*	*	*	*	*	*	*	*	*	*	*
D 3		UBJ 29		*	*	*	*	*	*	*	*	*	*	*	*	*
D 5SF 5		BJ 30	BJ330	*	*	*	*	*	*	*	*	*	*	*	*	*
D 3		BJ 31	BJ331	*	*	*	*	*	*	*	*	*	*	*	*	*
D 3		BJ 32	BJ332	*	*	*	*	*	*	*	*	*	*	*	*	*
D 3SF 8		BJ 38	BJ388	*	*	*	*	*	*	*	*	*	*	*	*	*
D 3		BJ 39	BJ339	*	*	*	*	*	*	*	*	*	*	*	*	*
D 5SF 5	U	BJ 40		*	*	*	*	*	*	*	*	*	*	*	*	*
D 3SF 6	U	BJ 41		*	*	*	*	*	*	*	*	*	*	*	*	*
D 2SF 3	U	BJ 46		*	*	*	*	*	*	*	*	*	*	*	*	*
D 8SF 12	U	BJ 46GF		*	*	*	*	*	*	*	*	*	*	*	*	*
D 3SF 7	U	BJ 47		*	*	*	*	*	*	*	*	*	*	*	*	*
D 3SF 7	U	BJ 48		*	*	*	*	*	*	*	*	*	*	*	*	*
D 8SF 11	U	BJ 48GF		*	*	*	*	*	*	*	*	*	*	*	*	*
D 2SF 3	U	BJ 49-6 Large body		*	*	*	*	*	*	*	*	*	*	*	*	*
D 3		UBJ 49		*	*	*	*	*	*	*	*	*	*	*	*	*
D 6		BJ 50/FL	BJ350	*	*	*	*	*	*	*	*	*	*	*	*	*
D 4SF 2		BJ 57/FL	BJ357	*	*	*	*	*	*	*	*	*	*	*	*	*
D 5SF 9		BJ 58/FL		*	*	*	*	*	*	*	*	*	*	*	*	*
D 4SF 4		BJ 59/FL	BJ359	*	*	*	*	*	*	*	*	*	*	*	*	*
D 2SF 8		BJ 72/TL/FL	BJ372	*	*	*	*	*	*	*	*	*	*	*	*	*
D 2SF 8		BJ 73/TL/FL	BJ373	*	*	*	*	*	*	*	*	*	*	*	*	*
D 2SF24		BJ 74/TL/FL	BJ374	*	*	*	*	*	*	*	*	*	*	*	*	*
D 2SF24		BJ 74C/TL/FL	BJ374C	*	*	*	*	*	*	*	*	*	*	*	*	*
D 2SF24		BJ 75/TL/FL	BJ375	*	*	*	*	*	*	*	*	*	*	*	*	*
D 4SF25		BJ 77/TL/FL	BJ377	*	*	*	*	*	*	*	*	*	*	*	*	*
D 3SF13		BJ 78/TL/FL	BJ378	*	*	*	*	*	*	*	*	*	*	*	*	*
D 3SF15		BJ 79/TL/FL	BJ379	*	*	*	*	*	*	*	*	*	*	*	*	*
D 3SF15		BJ 79C/TL/FL	BJ379C	*	*	*	*	*	*	*	*	*	*	*	*	*
D 1SF 1		BJ 80, BJ803	BJ380	*	*	*	*	*	*	*	*	*	*	*	*	*
D 1		BJ 83, BJ833	BJ383	*	*	*	*	*	*	*	*	*	*	*	*	*
D 1		BJ 88, BJ883	BJ388	*	*	*	*	*	*	*	*	*	*	*	*	*
D11		BJ 89	BJ389	*	*	*	*	*	*	*	*	*	*	*	*	*
DD6		BJ 89, BJ893	BJ389	*	*	*	*	*	*	*	*	*	*	*	*	*
DD1	U	BJ 95 Large Body		*	*	*	*	*	*	*	*	*	*	*	*	*
DD4	U	BJ 95		*	*	*	*	*	*	*	*	*	*	*	*	*
DD4	U	BJ 96		*	*	*	*	*	*	*	*	*	*	*	*	*
DD4	U	BJ 98		*	*	*	*	*	*	*	*	*	*	*	*	*
D 2SF 3		BJ 101		*	*	*	*	*	*	*	*	*	*	*	*	*
D 2SF 3		BJ 102		*	*	*	*	*	*	*	*	*	*	*	*	*
DD2SF14		BJ 130		*	*	*	*	*	*	*	*	*	*	*	*	*
DD2SF30		BJ 138		*	*	*	*	*	*	*	*	*	*	*	*	*
DD2SF30		BJ 139		*	*	*	*	*	*	*	*	*	*	*	*	*
D 4		BJ 150/FL	BJ3150	*	*	*	*	*	*	*	*	*	*	*	*	*
D 9		BJ 152/FL	BJ3152	*	*	*	*	*	*	*	*	*	*	*	*	*
D 9SF 12		BJ 153/FL	BJ3153	*	*	*	*	*	*	*	*	*	*	*	*	*
D 9SF 12		BJ 154/FL	BJ3154	*	*	*	*	*	*	*	*	*	*	*	*	*
D 9SF 12		BJ 154AC/FL	BJ3154AC	*	*	*	*	*	*	*	*	*	*	*	*	*
D 6		BJ 157/FL	BJ3157	*	*	*	*	*	*	*	*	*	*	*	*	*
D 5SF 9		BJ 158/FL		*	*	*	*	*	*	*	*	*	*	*	*	*
D 4SF 4		BJ 159/FL	BJ3159	*	*	*	*	*	*	*	*	*	*	*	*	*
D 4SF 4		BJ 159AC/FL	BJ3159AC	*	*	*	*	*	*	*	*	*	*	*	*	*
D 2SF 3	U	BJ 226		*	*	*	*	*	*	*	*	*	*	*	*	*
D 8SF 12	U	BJ 226GF		*	*	*	*	*	*	*	*	*	*	*	*	*
D 3	U	BJ 229		*	*	*	*	*	*	*	*	*	*	*	*	*
D 2SF 3	U	BJ 246		*	*	*	*	*	*	*	*	*	*	*	*	*
D 8SF 12	U	BJ 246GF		*	*	*	*	*	*	*	*	*	*	*	*	*
D 3		BJ 249		*	*	*	*	*	*	*	*	*	*	*	*	*
D 4SF 9			BJ358	*	*	*	*	*	*	*	*	*	*	*	*	*
DD8		BJ 450	BJ3450	*	*	*	*	*	*	*	*	*	*	*	*	*
DD8		BJ 457	BJ3457	*	*	*	*	*	*	*	*	*	*	*	*	*
DD8SF31		BJ 459	BJ3459	*	*	*	*	*	*	*	*	*	*	*	*	*
D11		BJ 893 Large body		*	*	*	*	*	*	*	*	*	*	*	*	*
D 3SF 7	U	BJ2848	Rear mount	*	*	*	*	*	*	*	*	*	*	*	*	*
D 4SF 9			BJ3158	*	*	*	*	*	*	*	*	*	*	*	*	*
D 3SF 7	U	BJ4828	Rear mount	*	*	*	*	*	*	*	*	*	*	*	*	*
D 9SF12		CBJ155/FL / BJ155	BJ3155	*	*	*	*	*	*	*	*	*	*	*	*	*
D 5SF10	U	J 95		*	*	*	*	*	*	*	*	*	*	*	*	*
D 4SF25		J 152FLFT		*	*	*	*	*	*	*	*	*	*	*	*	*
D 4SF25		J152FT	J3152FT	*	*	*	*	*	*	*	*	*	*	*	*	*
DD5SF6		PL 122		*	*	*	*	*	*	*	*	*	*	*	*	*
DD8SF31		TBJ 451/FL		*	*	*	*	*	*	*	*	*	*	*	*	*



## STANDARD 19" PANELS

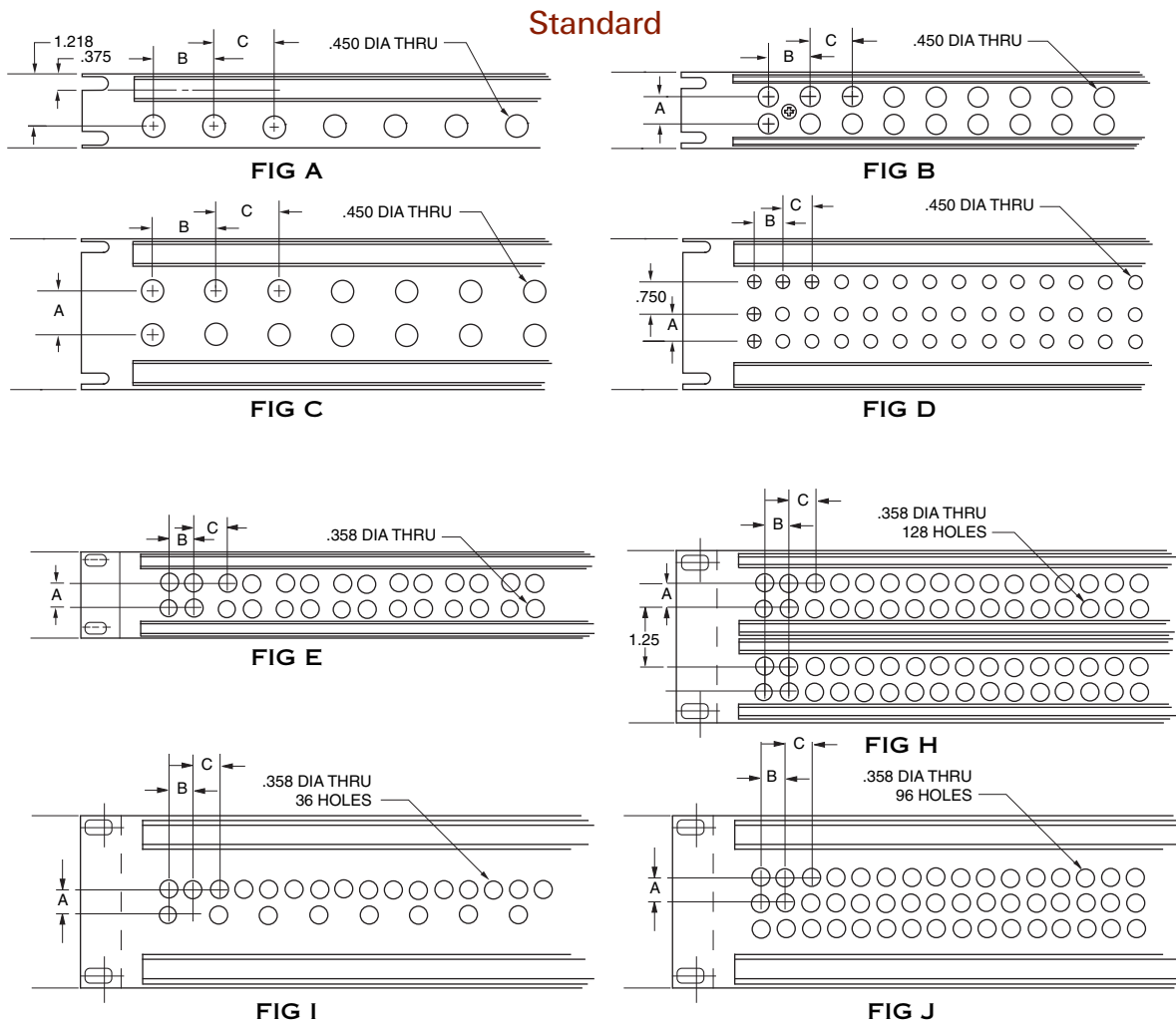

### 19" MINIATURE PATCH PANELS FOR: 50Ω J8 SERIES, J8D, AND 75Ω MINI-WECO JACKS

# of Patch Locations	Panel Height	Hole Spacing			Fig	Non-Insulated Part Number	Insulated Part Number	Jack Type
		A	B	C				
32	1.75"	N/A	.500	.500	A	JS-32	JSI-32	J8 Series
56	1.75"	.500	.500	.625	E		JSIX-56S	Mini-WECO
56	1.75"	.500	.500	.625	E		JSIX-56SF	Mini-WECO
64	1.75"	.500	.500	.500	E		JSIX-64S	Mini-WECO
64	1.75"	.500	.500	.500	E		JSIX-64SF	Mini-WECO
64	1.75"	N/A	.500	.500	A	JS-64	JSI-64S	J8 Series
64	3.50"	.500	.500	.500	E	JS-64L	JSI-64L	J8 Series
64	3.50"	.500	.500	.500	E		JSIX-64L	Mini-WECO
96	3.50"	.500	.500	.500	J	JS-96A	JSI-96A	J8 Series
96	3.50"	Not Shown				JS-96B	JSI-96B	J8 Series
128	3.50"	.500	.500	.500	H		JSIX-128	Mini-WECO

**Miniature 75Ω Coax Patch Panels ...** for high density, low VSWR, 75Ω coaxial applications (microwave, sub-carrier telephone systems, etc.). Trompeter's J12 jack/PL11C plug combination has a VSWR of 1:04:1 in the 60-80 MHz range. **Miniature 50Ω Coax Patch Panels...** for high density 50Ω patching. 19" panels tapped .312-32-2A to accept J8 and J8D jacks. .50" center-to-center vertical and horizontal hole spacing (unless otherwise noted), insulated and non-insulated panels have stiffener bars.

*Note: For Front Loading Modular Panels, see pages 14. "D" mounting hole specifications, see page 63. Many other panel configurations are available, contact the factory.*

# STANDARD 19" PANELS/D HOLE SPECIFICATIONS

## Standard Patch Panels

See page 62 for panel figure diagrams.

STANDARD 19" PANELS... INSULATED, NON-INSULATED									
# of Holes	Panel Height	A	Hole Spacing B	C	(Foot Note)	Fig	Non-insulated Part #	Insulated Part #	Insulated Phenolic Part #
12	1.75"	-	1.43"	1.43"	1	A	JS-12	JSI-12	
14	1.75"	-	1.21"	1.21"	1	A	JS-14	JSI-14	
16	1.75"	-	1.00"	1.00"	1	A	JS-16	JSI-16	
20	1.75"	-	.830"	.830"	1	A	JS-20	JSI-20	
24	1.75"	-	.625"	.750"	1	A	JS-24S	JSI-24S	
26	1.75"	-	.625"	.625"	1	A	JS-26	JSI-26	
28	1.75"	-	.625"	.625"	1	A	JS-28	JSI-28	
32	1.75"	.625"	1.00"	1.00"	2	B	JS-32S	JSI-32S	JSIB-32S
40	1.75"	.625"	.830"	.830"	2	B	JS-40S	JSI-40S	JSIB-40S
48	1.75"	.625"	.625"	.750"	2	B	JS-48S	JSI-48S	JSIB-48S
52	1.75"	.625"	.625"	.625"	2	B	JS-52S	JSI-52S	JSIB-52S
24	3.50"	.625	1.43"	1.43"	2	C	JS-24L	JSI-24L	
24	3.50"	1.00"	1.43"	1.43"	1	C	JS-24W	JSI-24W	
28	3.50"	.625"	1.21"	1.21"	2	C	JS-28A	JSI-28A	
28	3.50"	1.00"	1.21"	1.21"		C	JS-28W	JSI-28W	
32	3.50"	.625"	1.00"	1.00"	2	C	JS-32A	JSI-32A	JSIB-32A
36	3.50"	.625"	.625"	.750"	2	I	JS-36	JSI-36	
36	3.50"	.625"	.830"	.830"	2	C	JS-36A	JSI-36A	
40	3.50"	.625"	.830"	.830"	2	C	JS-40	JSI-40	JSIB-40
40	3.50"	1.00"	.830"	.830"	1	C	JS-40W	JSI-40W	JSIB-40W
48	3.50"	.625"	.625"	.750"	2	C	JS-48	JSI-48	JSIB-48
48	3.50"	.625"	.625"	.625"	2	C	JS-48A	JSI-48A	JSIB-48A
52	3.50"	1.00"	.625"	.625"		C	JS-52W	JSI-52W	JSIB-52W
52	3.50"	.625"	.625"	.625"	2	C	JS-52	JSI-52	JSIB-52
56	3.50"	.625"	.625"	.625"	2	C	JS-56	JSI-56	JSIB-56
72	3.50"	.625"	.680"	.680"	3	D	JSS-72	JSIS-72	

1 Will not accept dual jacks (e.g. J14, J214, J314, J74, HDVDP) 2 Will not accept jacks requiring hole spacing(A) larger than .625" 3 Will accept 3 barrel jack only

Note: JSIB (Fig. B and C) panels have .459 dia typ.

## "D" Hole Specifications

Throughout the catalog you will find "D" holes called out for bulkhead jacks. The "D" hole is the cutout pattern designated for the proper fit of bulkhead jacks into distribution panels.

"D" Hole Type Maximum panel thickness **Example: D3.148**

"D" Hole Type	A		B		Double "D" Hole	A		B	
	A	B	A	B		A	B	A	B
D1	.755"	.343"	DD1	.630"	.532"				
D2	.630"	.281"	DD2	.380"	.312"				
D3	.505"	.218"	DD3	.505"	.443"				
D4	.439"	.187"	DD4	.630"	.562"				
D5	.380"	.156"	DD5	.475"	.436"				
D6	.317"	.128"	DD6	.755"	.690"				
D7	.281"	.125"	DD7	1.140"	1.060"				
D8	.605"	.280"	DD8	.330"	.274"				
D9	.567"	.257"							
D10	.192"	.079"							
D11	1.005"	.470"							

Many other panel hole configurations available, contact the factory.

### "D" HOLES

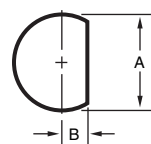

### DOUBLE "D" HOLES

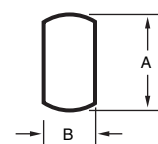

### Circular Hole

	A
C1	.317"-321"
C2	.380"-385"
C3	.442"-447"
C4	.474"-480"
C5	.505"-510"
C6	.755"-760"

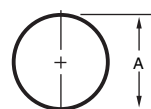

### Double Circular Hole

	A	B	C
CC1	.630"	.370"	.136"-140"

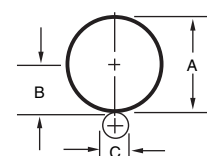

### CIRCULAR HOLES

## CUSTOM CABLE ASSEMBLIES

### Custom Cable Assembly Lines

Trompeter's coax patch cords and cable assemblies are of the highest quality and can be ordered in any length. Trompeter normally stocks popular lengths of 6", 12", 18", 24", 36", 48", 60", and 72". Standard coax patch cords and cable assemblies are made with the following cables: Patch Cords and Cable Assemblies are available in 50Ω RCA Standard or 75Ω Western Electric (WECo) Standard. The two standards are *not* intermateable. "L" denotes the length in inches. "Z" denotes the impedance of the connecting cable. Trompeter stocks many other connector types for 24 to 48 hour turnaround of custom cable assemblies including:

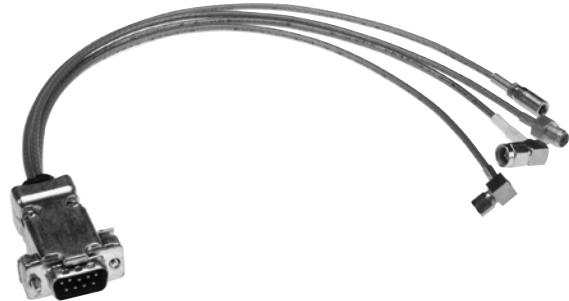

#### D-Subs & Backshells:

Male & Female 9,15,25,37 pin and more.

#### SMA/SMB/SMCs:

Straight and Right Angles for RG-58, RG-142, RG-174, RG-188, RG-316, and RG-400.

Impedance	Cable Type	Trompeter Cable Part #
50Ω	RG-58	TCC-50-2
75Ω	RG-59	TCC-75-2
93Ω	RG-62	N/A

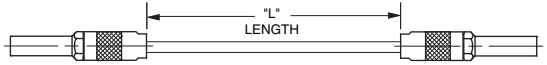
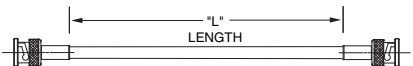
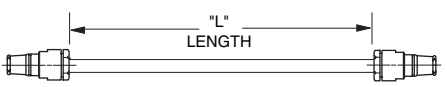
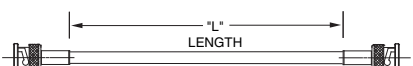
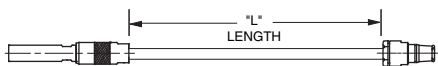
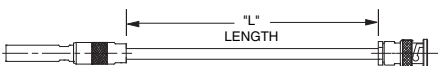
 <p><b>PATCH CORDS</b> (SEE P/N BELOW)  <b>PATCH PLUG TO PATCH PLUG</b>                      50Ω RCA PLUG CENTER PIN .070" <b>PC-L-Z</b>                      75Ω WE CENTER PIN .090" <b>PCW-L-Z</b>                      75Ω MINI-WECO <b>PCMW-L-Z</b></p>	 <p><b>CABLE ASSEMBLY</b>  <b>BNC PLUG TO BNC PLUG</b>                      TOOL CRIMP BNC <b>50Ω PCYC-L-Z</b>  <b>75Ω UPCYC-L-Z</b></p>
 <p><b>CABLE ASSEMBLY</b>  <b>PUSH-ON PLUG TO PUSH-ON PLUG</b>                      50Ω PUSH-ON <b>PCP-L-Z</b>                      75Ω PUSH-ON <b>UPCP-L-Z</b>                      Wrench Crimp push-on plugs fit both BNC and TNC jacks.</p>	 <p><b>CABLE ASSEMBLY</b>  <b>BNC PLUG TO BNC PLUG</b>                      WRENCH CRIMP <b>50Ω BNC PCY-L-Z</b>  <b>75Ω BNC UPCY-L-Z</b></p>
 <p><b>CABLE ASSEMBLY</b>  <b>PATCH PLUG TO PUSH-ON PLUG</b>                      50Ω RCA PLUG CENTER PIN -.070" TO 50Ω PUSH-ON <b>PCPX-L-Z</b>                      50Ω RCA PLUG CENTER PIN -.070" TO 75Ω PUSH-ON <b>UPCPX-L-Z</b>                      75Ω WE CENTER PIN -.090" TO 50Ω PUSH-ON <b>PCPWX-L-Z</b>                      75Ω WE CENTER PIN -.090" TO 75Ω PUSH-ON <b>UPCPWX-L-Z</b></p>	 <p><b>CABLE ASSEMBLY</b>  <b>PATCH PLUG TO BNC PLUG</b>                      50Ω RCA PLUG CENTER PIN .070" TO 50Ω BNC <b>PCX-L-Z</b>                      50Ω RCA PLUG CENTER PIN .070" TO 75Ω BNC <b>UPCX-L-Z</b>                      75Ω WE CENTER PIN .090" TO 50Ω BNC <b>PCWX-L-Z</b>                      75Ω WE CENTER PIN .090" TO 75Ω BNC <b>UPCWX-L-Z</b></p>

# CUSTOM CABLE ASSEMBLIES

Contact our rapid response Custom Cable Assembly Department for your cable needs. These paralleling cables can be specified with many other connector, cable, and color combinations.

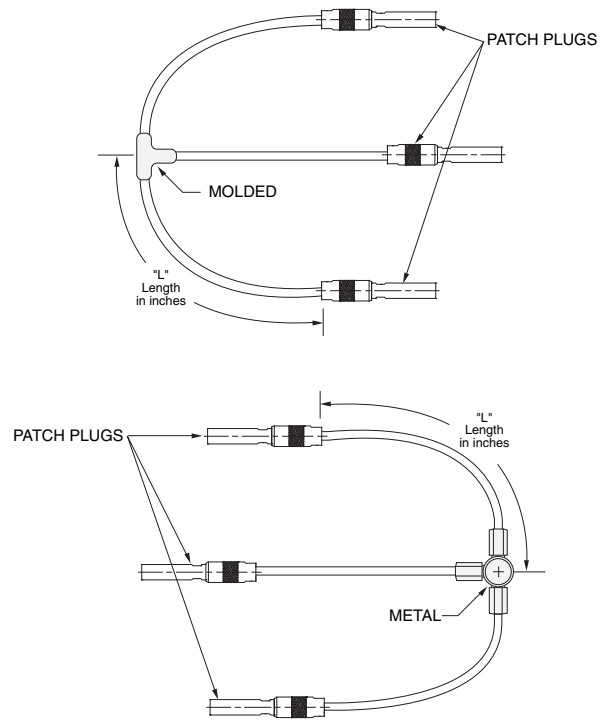
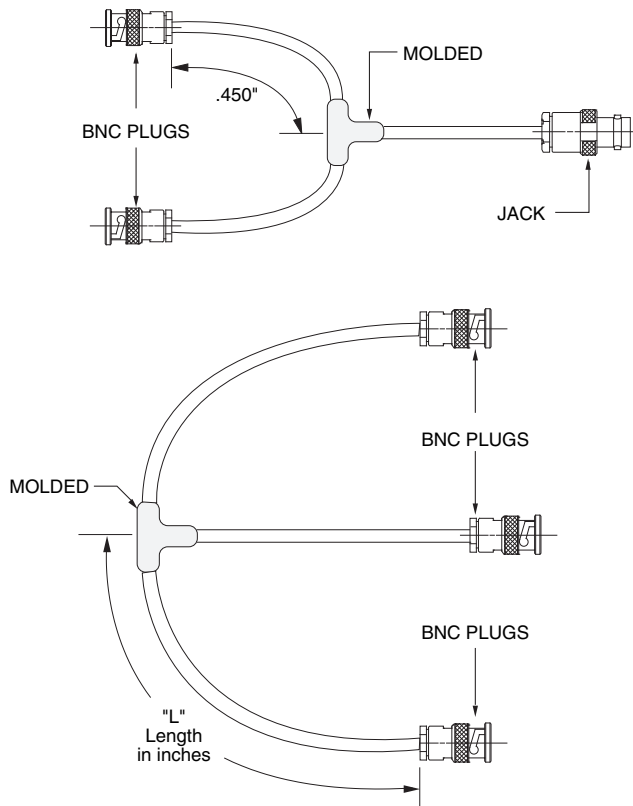

## CABLE ASSEMBLIES

### RANDOM PARALLELING

JUNCTION	CONNECTORS	PART #
MOLDED	50Ω BNC-Two plugs, one jack	*PN2B-Z
MOLDED	75Ω BNC-Two plugs, one jack	UPN2B-Z
METAL	50Ω BNC-Two plugs, one jack	PN2BE-Z
METAL	75Ω BNC-Two plugs, one jack	**UPN2BE-Z
MOLDED	50Ω BNC-Three plugs, no jack	*PN3-Z
METAL	50Ω BNC-Three plugs, no jack	PN3E-Z
METAL	50Ω BNC-Four plugs, one jack	PN4-Z

\* 50Ω or 75Ω Cable only  
 \*\* 75Ω or 93Ω Cable only

### PATCH CORDS TRIPLE PARALLELING

JUNCTION	STANDARD	MAXIMUM LENGTH	PART#
MOLDED	50Ω RCA CENTER PIN-.070"	14"	PCS-L-Z
METAL	50Ω RCA CENTER PIN-.070"	None	PCSE-L-Z
MOLDED	75Ω WE CENTER PIN-.090"	14"	PCWS-L-75
METAL	75Ω WE CENTER PIN-.090"	None	PCWSE-L-75

Note: "Z" replace with impedance in ohms. "L" replace with length in inches.

## CUSTOM CABLE ASSEMBLIES

### Custom Cable Assemblies

Trompeter provides all the flexibility and response of a small cable shop, with the quality system and design control of a major connector manufacturer. For over 35 years, Trompeter has been producing high quality cable assemblies, and currently provides over 500,000 different configurations using a broad range of RF connectors and cable types. We stock a variety of components for camera, RGB, S-Video, Audio, and many other applications.



Photo: Twinax/Triax connectors on ruggedized dual twinax/triax test cable (fire retardent cables).

### Capabilities

Trompeter can provide coax, twinax, and triax cable assemblies using any cable attached connector. This includes panel mount, data bus, multi-pin, D-Subs, SMA connectors, and patching products. Special marking (ID sleeves/tags, hot stamping, colored cable jacket, etc.) is available. Trompeter offers 24-48 hour turnaround on many standard products with full capabilities for sustained volume delivery. Deliveries can be adjusted to meet your specific needs.

### Quality Assurance... ISO 9001 Registered

Trompeter's assemblies are 100% electrically tested for continuity, shorts, and Hi-Pot. (VSWR, IR, Insertion / Return Loss test capabilities, SPC data available on request).

Request For Quote... Please refer to the following guideline when requesting a quote:

1	2	3	4	5	6
Qty	Conn 1	Cable	Conn 2	Length	Special Requirements
12	UPL220	735A	PL11C	60"	Bend relief on Conn 1
	/	/	/	/	/
	/	/	/	/	/

- 1 **Quantity** ..... **Select quantity**
- 2 **Conn1** ..... Select connector type from catalog.
- 3 **Cable** ..... Select cable from pages 82-124.
- 4 **Conn2** ..... Select connector type from catalog.
- 5 **Length** ..... In inches
- 6 Write out any **special marking**, testing, bend relief, packaging, or other **requirements**.

**EXAMPLE SHOWN:** 60 inch coax cable assembly using AT&T 735A, BNC plug, and Mini-WECO patch plug with bend relief on BNC plug.

# COAX RFI CAPS & TERMINATIONS

## Coax Terminations and RFI (Dust Caps)

Trompeter provides termination and RFI cap for all our connectors. Resistors are normally ¼ watt for subminiature connectors and ½ watt for miniature and standard size connectors (1% tolerances for all).

### Ordering Instructions

**For Terminations Example: PL75 Termination for TRB jacks with 78Ω resistance and no chain.**

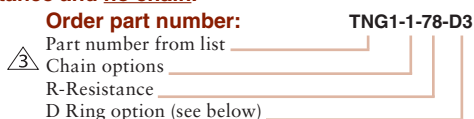

**For RFI Caps Example: Patch plug cap for a J74 twinax/triax jack with no chain.**

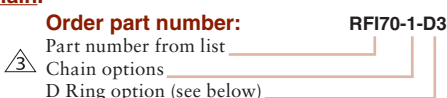

### Chain Options

LENGTH	CHAIN TYPE	CHAIN NUMBERS
N/A	No Chain	-1
2.5"	Brass Chain	-2
2.5"	Nylon Chain	-3
3.0"	Brass Chain	-4
3.0"	Nylon Chain	-5
6.0"	Brass Chain	-6
6.0"	Nylon Chain	-7
4.0"	Brass Chain	-8
4.0"	Nylon Chain	-9
10.0"	Brass Chain	-10
10.0"	Nylon Chain	-11
<b>STAINLESS-STEEL ROPE</b>		
2.5"	Jacketed Stainless-steel rope	-12
3.0"	Jacketed Stainless-steel rope	-13
6.0"	Jacketed Stainless-steel rope	-14
4.0"	Jacketed Stainless-steel rope	-15
7.0"	Jacketed Stainless-steel rope	-16
4.5"	Jacketed Stainless-steel rope	-17
12"	Jacketed Stainless-steel rope	-18

## Stainless Steel Rope with Mounting Rings

We now *provide* stainless steel rope with “D” rings. To order mounting ring for jacks with the “D” mounting hole numbers listed on the right, add the “D” ring number to the part number. **For Example: RFI20-12-D2**

### D Ring Options

INSIDE DIAMETER	D-RING#	INSIDE DIAMETER	D-RING#
.755"	<b>-D1</b>	.281"	<b>-D7</b>
.630"-.635"	<b>-D2</b>	.610"	<b>-D8</b>
.505"-.510"	<b>-D3</b>	.567"	<b>-D9</b>
.439"-.443"	<b>-D4</b>	.192"	<b>-D10</b>
.380"-.384"	<b>-D5</b>	1.005"	<b>-D11</b>
.317"	<b>-D6</b>	.330"	<b>-DD8</b>

## Coax Terminations & RFI Caps

PARTS TO BE CAPPED	DESCRIPTION	TERMINATOR	RFI (DUST CAPS)
BJ20/CJ20 Series	BNC, Jack	(U)TNASP1-(3)-R (Push on)	RFI25-(3)
BJ20/CJ20 Series	BNC, Jack	(U)TNAS1-(3)-R (Short)	RFI25-(3)
BJ20/CJ20 Series	BNC, Jack	(U)TNA1-(3)-R	RFI25-(3)
BJ20/CJ20	BNC, Jack	(U)TNAP1-(3)-R	RFI25-(3)
BJ40/CJ40 Series	TNC, Jack	(U)TNH1-(3)-R	RFI45-(3)
BJ50/CJ50 Series	TPS, Jack	TNB1-(3)-R (Push on)	RFI55-(3)
BJ50FL/CJ50FL Series	TPS, Jack	TNBP1-(3)-R (Push on)	RFI55FL-(3)
BJ50/BJ350	TPS/TCM, Jack	TNBP1-(3)-R (Push on)	RFI355-(3)
BJ95	N, Jack	(U)TNN1-(3)-R	RFI95-(3)
BJ130	F, Jack	TNF1-(3)-R	RFI130-(3)
J3	RCA, Patch Jack	TP-(3)-R	RFI20-(3)
J3W	WECO Patch Jack	TPW-(3)-R	RFI20-(3)
J8	Mini-WECO Coax Patch Jack	TPM-(3)-R	RFI50-(3)
J11	Mini-WECO Patch Jack	TPMW-(3)-R	RFI150-(3)
J94 (90 Series)	Patch Jack	TNP1-(3)-R	RFI94-(3)
J94 (90 Series)	Patch Jack	TPP-(3)-50 (Push-on)	RFI94-(3)
PL20 Series	BNC, Plug	(U)TNAF1-(3)-R	RFI21-(3)
PL50	TPS, Plug		RFI57-(3)
PL50FL	TPS, Plug		RFI57FL-(3)
PL220 Series	BNC, Plug	(U)TNAF1-(3)-R	RFI21-(3)
PL40 Series	TNC, Plug	(U)TNHF1-(3)-R	RFI41-(3)
PL95	N, Plug	(U)TNNBJ1-(3)-R (Bulkhead Mount)	RFI97-(3)/ RFIS97-(3) Safety wire

Notes: (3) See Chain options. “U: Designates 75 ohm version available. “R” Resistance. If you cannot find the RFI cap or termination you need call the factory.

## ADAPTER: CIRCUITRY SCHEMATICS, IMPEDANCE MATCHING

### Custom Adapters Ordering Format

Adapters indexed with a designated number are *standard adapters*, refer to page 50 for identifications. Adapters index with a “•” are *custom adapters* and may be ordered using the example below. For adapters not referenced contact the factory.

#### ORDERING EXAMPLE:

Conn #1      **BJ20**    BNC JACK  
 Schematic    **E1**        CIRCUIT CODE  
 Conn #2      **PL75**    TRB PLUG

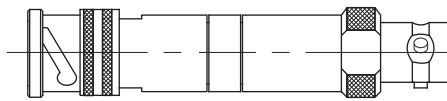

Schematic  
 Conn #1    Conn #2  
**ADBJ20 - E1 - PL75**

### Adapter Circuitry Schematics

Concentric Twinax/Triax to Concentric Twinax/Triax	2-Pin Twinax to 2-Pin Twinax	Coax 2-Pin Twinax	Coax to Concentric Twinax/Triax	2-Pin Twinax to Concentric Twinax/Triax	Coax to Coax
A1	C1	D1	E1	G1	K1
A2	C2	D2	E2	G2	K2
A3	C3	D3	E3	G3	K3
A4	C4	D4	E4	G4	
A5	C5	D5	E5		
A6	C6	D6			
A7	C7	D7			
A8		D8			

• BLUE CENTER COND

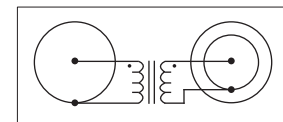

IMPEDANCE MATCHING SCHEMATIC

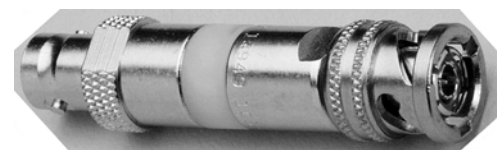

### Impedance Matching Adapter

Trompeter has developed a line of *Impedance Matching Adapters* that provides the designer a quick, elegant and affordable solution for connecting mismatched data transfer devices.

Why impedance matching? Impedance Matching exists in order to improve the performance of electronic circuits. A transmission line is properly terminated when the load impedance is equal to the source impedance. This prevents reflections and transfers the maximum signal to the output. Data transfer rates are increasing and frequency is an important component in determining the impedance of a transmission medium. When devices are not properly matched, the higher frequencies create greater signal attenuation.

Trompeter incorporates embedded transformer technology into our rugged in-line adapter package. The transformers are step-up/down and DC isolated so you do not have to contend with your signal floating on a DC level. These *Impedance Matching Adapters* are available in BNC, TNC, TRB and TRT, male and female interfaces. The input/output configurations are interchangeable, i.e. TRB to BNC, with bulkhead mounting options.

For more information on how this product can benefit your design, please refer to the technical paper: [Signal Transmission in High Frequency/High Density Applications](#) (see pages 129-130 in this catalog). For specific information and part numbers please contact the factory.







# ADAPTER TABLE: COAX/TWINAX/TRIAX & IDENTIFICATIONS

Coax/Twinax/Triax Adapters Continued...

				TRB								TRT				TWBNC			TWTNC								
				BJ77	BJ77FL	BJ77TL	BJ79	CJ70	CJ70FL	CJ70TL	PL74	PL75	PL75FL	BJ874	BJ877	BJ879	CJ870	PL875	BJ90	BJ89	CJ90	PL90	BJ830	BJ839	CJ830	PL830	
				F	F	F	F	F	F	M	M	M	F	F	F	F	M	F	F	F	M	F	F	F	F	F	M
TRS	BJ154	F	B	I	*	*	*																				
	BJ154FL	F	B	I	*	*	*																				
	BJ157	F			*																						
	BJ157FL	F			*																						
	BJ159	F	B		*	*	*																				
	BJ159FL	F	B		*	*	*																				
	CJ150	F			*	*	*																				
	CJ150FL	F			*	*	*																				
	PL150	M			*	*	*																				
	PL153	M			*	*	*																				
PL155	M			*	*	*																					
PL155FL	M			*	*	*																					
TTM	BJ3154	F	B	I	*	*	*																				
	BJ3159	F	B		*	*	*																				
	CJ3150	F			*	*	*																				
	PL3155	M			*	*	*																				
TRB	BJ74	F	B	I	18	*	18	18																			
	BJ74TL	B	B	I	*	*	39		39	*	*	*															
	BJ74FL	F	B	I	40	*	40			*	*	*															
	BJ77	F			3	*	34	3		*	*	*															
	BJ77TL	F			29	*	29			*	*	*															
	BJ77FL	F			28	*	28			*	*	*															
	BJ79	F	B		34	*	34	34			*	*	*														
	BJ79TL	F	B		35	*	35				*	*	*														
	BJ79FL	F	B		36	*	36				*	*	*														
	BJ79TLRG	F	B																								
	CJ70	F			3	*	34	3			*	*	*														
	CJ70TL	F			29	*	29				*	*	*														
	CJ70FL	F			28	*	28				*	*	*														
	PL71	M			*	*	*																				
	PL73	M			*	*	*																				
	PL74	M			*	*	*																				
PL75	M			*	*	*																					
PL75FL	M			*	*	*																					
TRT	PL375	M			*	*	*																				
	BJ374	F	B	I	*	*	*		25	25	25	25	*	*	*												
	BJ377	F			*	*	*		25	12	26	12	*	*	*												
	BJ379	F	B		*	*	*		25	26	26	26	*	*	*												
	BJ379RG	F	B		*	*	*						*	*	*												
CJ370	F			*	*	*		25	12	26	12	*	*	*													
TWBNC	BJ30	F														15	15	15	*	*	*						
	BJ39	F	B													15	15	15	*	*	*						
	CJ30	F			*	*	*									15			*	*	*						
	PL30	M			*	*	*												*	*	*						
TWTNC	BJ330	F																					37	*	*		
	BJ339	F	B																				37	37	37		
TRC/TRN	PL330	M			*	*	*																				
	BJ89	F	B		*	*	*																				
	BJ89F	F	B		*	*	*																				
	BJ893	F	B		*	*	*																				
	BJ893F	F	B		*	*	*																				
	CJ80	F			*	*	*																				
	CJ380	F			*	*	*																				
	CJ803	F			*	*	*																				
	PL80	M			*	*	*																				
	PL380	M			*	*	*																				
PL803	M			*	*	*																					
BJ389	F	B		*	*	*																					
BJ389F	F	B		*	*	*																					
PATCH	J72D	F	B		67		67									*											
	J150	F	B																								
	PL150	M																									

Adapters indexed with a designated number are standard adapters, use the table below to determine the part number. Adapters indexed with a “•” are custom adapters, see page 68. Trompeter also carries *Impedance Matching Adapters*, see page 68.

STANDARD ADAPTERS IDENTIFICATION NUMBERS:			
ID#	Part Number	ID#	Part Number
1	(U)AD28	41	BJ883
2	(U)AD48	42	BJ58FL
3	AD78 (Note 2)	43	BJ138
4	AD1	44	AD192
5	(U)AD95	45	AD1W
6	(U)ADI95	46	ADH1
7	ADI22	47	ADH1W
8	AD130	48	ADM1 (Note 8)
9	AD131	49	ADM2 (Note 8)
10	AD133	50	ADMW12 (Note 9)
11	(U)AD142	51	J11 (Note 9)
12	AD378	52	J11B (Note 9)
13	(U)AD2848	53	J152 (Note 11)
14	(U)BJ28	54	J152FL (Note 12)
15	BJ38 (Note 3)	55	J3152 (Note 13)
16	(U)BJ48	56	J3
17	BJ58	57	J3W
18	BJ73 (Note 2)	58	(Note 10)
19	BJ88	59	AD158FL
20	(U)BJ98	60	J3F
22	BJ158 (Note 4)	61	J3WF
23	BJ158FL (Note 5)	62	J5
24	BJ358	63	J5W
25	BJ373	64	(U)J9
26	BJ378	65	(U)J9W
27	(Note 1)	66	J8
28	AD78FL	67	J72
29	AD78TL	68	BJ3153
30	BJ24		
31	BJ3158 (Note 6)		
32	AD158		
33	AD3158		
34	BJ78		
35	BJ78TL		
36	BJ78FL		
37	BJ338		
38	BJ388 (Note 7)		
39	BJ73TL		
40	BJ73FL		

(U) = 75 ohm version available (Note) = See below

**STANDARD ADAPTER NOTES:**

<b>Note:</b>	1	Bulkhead Mounted BNC Side	(U)BJ4828
		Bulkhead Mounted TNC Side	(U)BJ2848
	2	Polarization Table (Call Factory)	
	3	Insulated Version	BJ33
	4	Insulated Version	BJ153
	5	Insulated Version	BJ153FL
	7	Insulated Version	BJ383
	8	50 Ohm Version Only	
	9	75 Ohm Version Only	
	10	J308 50 Ohm TCM Jack Threaded	
		Panel Mount J8D	
	11	J311 75 Ohm TCM Jack to J8D	
		Threaded Panel Mount	J152
12	Threaded Panel Mount	J152FLFT	
13	Threaded Panel Mount	J3152FT	

## TOOLS & ACCESSORIES

### Powered Cable Stripper



This powerful, low-cost, portable hand-held (less than 2.25 lbs) cable stripper delivers, production quality performance, and gives you up to 250 strips per charge (7.2 V Ni-cad battery without memory effect). The replaceable, 3-level cutter head, is preset to strip your coax cable for Trompeter's 220 Series, Tool Crimp BNC connectors. The cutter head has adjustable depth cutter blades for precision tuning. Precision ground, tool steel blades (hardened to Rockwell 64) give you up to 15,000 strips! Rapid Charger/Reconditioner recharges your Ni-Cad in only 1.5 hours! Fast charge: 1.5 hrs/Recondition in 3.1 hrs.

### Powered Cable Stripper Kits... (1-year Warranty)

**Includes:** 1 Driver, 1 Ni-Cad Battery Pack, 1 Cutter Head, 1 Rapid Charger/Reconditioner Station, and 1 Carrying Case.

#### CABLE TYPE STRIPPER/CUTTER HEAD

FOR RG-59      **BCCS/C24T3D**  
 FOR 8281      **BCCS/C24T3U**

### Cutter Head Guide

Cable Outside Diameter	2-Blade Cut	3-Blade Cut
.070-.110	<b>C24T2A</b>	<b>C24T3A</b>
.160-.215	<b>C24T2B</b>	<b>C24T3B</b>
.190-.230	<b>C24T2C</b>	<b>C24T3C</b>
.235-.270	<b>C24T2D</b>	<b>C24T3D</b>
.300-.430	<b>C24T2E</b>	<b>C24T3E</b>
.110-.160	<b>C24T2I</b>	<b>C24T3I</b>
.271-.305	<b>C24T2U</b>	<b>C24T3U</b>

**Important Note:** The 3-level cutter heads included in the kits are set to the same stripping dimensions as our STC-F (see below) stripping cassette for Trompeter "Tool Crimp" BNC cable connectors.

Use 2-level cutter heads for Trompeter "Wrench Crimp" BNC cable connectors.

### Additional Accessories...

Extra Cutter heads      *See guide above*  
 DC Driver Battery - Requires cutter head from above      **BCS**  
 AC Driver and AC Base Unit - Requires cutter head from above      **ACS**

Rapid Charger/Reconditioner      **BRCC**  
 Ni-Cad Battery Pack      **ABP-NSA**  
 AC Power Converter      **ACC-NSA**

### Manual Cable Stripping Tools

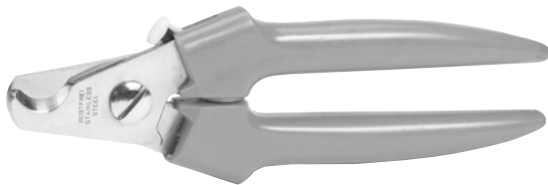

### Cable Cutting Tool

Designed to cut Coax cable without compressing dielectric or damaging center conductor.

**CUTTING TOOL    700-0024**

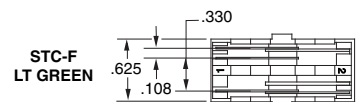
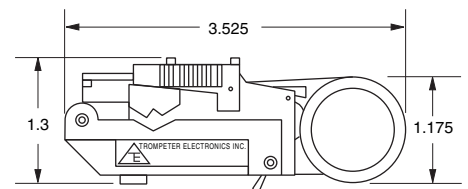

### Cable Stripping Tool

Tool (only) - Requires blade cassette listed      **ST1**  
 Cassette (For Tool Crimp BNC Connectors)      **STC-F**  
 Cassette (For Wrench Crimp BNC Connectors)      **STC-W**

# TOOLS & ACCESSORIES

## Crimp Tools



### 8-POINT CRIMP TOOL 75Ω CENTER CONTACT PIN (HANDLE COLOR)

- BNC/TNC PLUGS (RED) 010-0055
- PL11 PATCH PLUGS (BLUE) 010-0070
- BNC/PL11 PATCH PLUGS (RED/BLUE) 010-0097
- BNC JACK AND PLUG (BLUE) 010-0088

### 12-POINT CRIMP TOOL 75Ω CENTER CONTACT PIN (HANDLE COLOR)

- BNC/TNC (YELLOW) 010-0080
- BNC/TNC/PL11 PATCH PLUG (GREEN/YELLOW) 010-0098



CT4L (RECOMMENDED)

### CRIMP TOOL (Die not included, for crimp dies see below)

FRAME **CT4L** (BLACK W/ LONGER ERGONOMIC HANDLE)

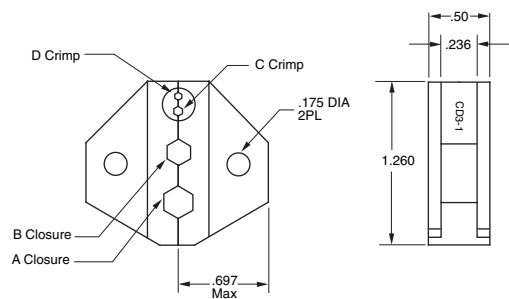

Outer Sleeve	A	Embosses	B	Embosses
CD3-1	.213	1A	.178	1B
CD3-2	.324	2A	.255	2B
CD3-3	.344	3A	.290	3B
CD3-5	-	-	.197	5B
CD3-21	.290	290	.255	255
CD3-22	.404	404	.068	-

For crimp dies not listed, call the factory.

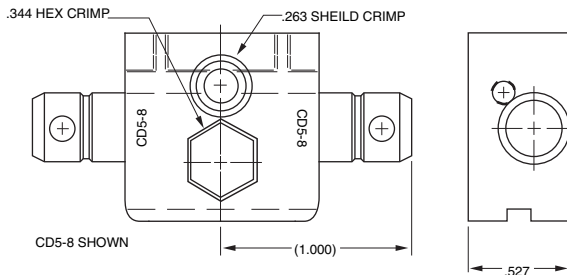

For Standard and Miniature Twinax/Triax patching: 70 Series: TRB/TRT, 150 Series: TRS/TTM, 450 Series: 2-lug/3-lug/threaded connectors.



### TWINAX/TRIAX CRIMP TOOL

#### FOR BUSHING/SHIELD

- CRIMP TOOL ONLY M22520/5-01
- CRIMP TOOL WITH DIE M22520/5-01/CD5-#

Connector Series	Cable Type	Cable Group#	Bushing/Shield Crimp Die	Center Contact Crimp Tool Part #	Center Contact Positioner Part #
70C PLR70C PLR155AC	Twinax	201-225	CD5-8	M22520/1-01	010-0044 Pin (TP837) 010-0045 Socket (TP838)
	Triax	301-309	CD5-10		
Small Body 150AC	Twinax	201-206, 208, 209, 217-223	CD5-9	M22520/2-01	010-0041
	Triax	301-304, 309	CD5-11		
Large Body 150AC	Twinax	207, 210, 211-216, 224-225	CD5-8	M22520/2-01	010-0043
	Triax	305-306, 308	CD5-13		
	Triax	307	CD5-10		
PL75MC	Twinax	201-225	CD5-14	M22520/2-01	010-0096
		226	CD5-15	M22520/2-01	010-0096
450AC	Twinax	201-206, 208, 209, 212, 217-223	CD5-9	M22520/2-01	010-0041
PLR450	Twinax	201-206, 208, 209, 212, 217-223	CD5-120	M22520/2-01	010-0041
SPC8P	Twinax	201-205, 217, 218, 221, 222	CD5-4	M22520/2-01	Daniels K709
SPC8S	Triax	301-303	CD5-7		

\* Note: Dies imprint either cavity (A/B) or hex size onto crimp sleeve. Custom dies are available for special imprints.

## TOOLS & ACCESSORIES

### Twinax/Triax Cable Assembly Tester



The Twinax/Triax Cable Assembly Tester is designed to test for opens, shorts, and cross wired connectors. The tester comes complete with terminators and testing instructions. This tool is designed to provide quick verification of TRB cable assemblies in the palm of your hands. The compact hand held unit measures 2<sup>3</sup>/<sub>4</sub>" x 4<sup>1</sup>/<sub>2</sub>" and provides versatility for testing connectors in the field. The unit comes in a soft zipper case which includes a 9v battery and terminators for standard TRB plugs. It can also be used for other connector families with an adapter, or short jumper cable when used with the proper termination.

#### TWINAX/TRIAX CABLE ASSEMBLY CONNECTOR TEST SET 010-0123-1

- 3 Conductors which test for opens, shorts, and cross connects
- Concentric TRB Interface, which tests both Twinax and Triax
- Pass/Open/Short LED indicators
- Easy to follow testing instructions
- Complete with terminators, carrying case, and a 9V battery.

### BNC Coax Tester

Designed to test for the proper assembly of BNC plugs with *coax* cables. Tests for center contact pin height and continuity (short or open). The new BNC tester is the same size as the twinax/triax tester but exclusively tests only BNC plugs. Mini-WECO continuity test adapter now available (sold separately).

- Compact design
- Pass/Open/Short LED indicators
- One test required for testing remote cable runs
- Easy to follow instructions
- Complete with terminators, case, and 9V battery
- On/Off switch



#### COAX CABLE ASSEMBLY CONNECTOR TEST SET

75Ω BNC PLUG 010-0133  
75Ω MBNC PLUG 010-0208

#### MINI-WECO ADAPTER (CONTINUITY ONLY) SOLD SEPARATELY 105-1885

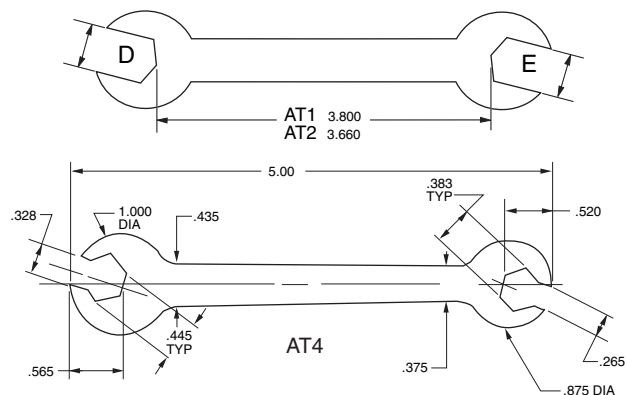

#### ASSEMBLY TOOLS

WRENCH CRIMP TYPE	D	E
AT1 BNC/N/TNC	.507	.445
AT2 TPS/TCM	.381	.318
AT4 TPS/TRS/TTM	See Drawing	



# TOOLS & ACCESSORIES

## Tool Kits



Tool Kit Part Number	Pin Height Indicator	Crimp Tool 8-Point Indentor	Crimp Tool 12-Point Indentor	BNC/Mini-WECO Electrical Gauge	Crimp Die	Center Contact Gauge
TK4NL-1	UPLCG-1	010-0097	Not Included	Not Included	CD3-19	Not Included
TK4NL-1A	UPLCG-1	010-0097	Not Included	Not Included	CD3-19	Not Included
TK4NL-2	UPLCG-1	Not Included	010-0098	Not Included	CD3-19	Not Included
TK4NL-3	UPLCG-1	010-0097	010-0098	Not Included	CD3-19	Not Included
TK4NL-4	Not Included	010-0097	Not Included	010-0108	CD3-19	Not Included
TK4NL-5	Not Included	Not Included	010-0080	010-0108	CD3-19	010-0101

All Tool Kits Include: Case, *BCS Cable Stripper* with BCS Cutter heads (one *C24T3D* and one *C24T3I*), Cable Cutter (part number *700-0024*), and Ergonomic Crimp Tool w/long handle *CT4L* with Crimp Die *CD3-19* embosses the die cavity size on the crimp sleeve either .178 or .255. Contact the factory for custom tool kits.

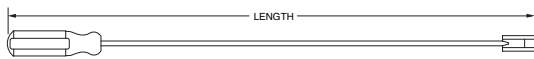

### CONNECTOR REMOVAL TOOLS

BNC/TRB CABLE PLUG	TYPE	LENGTH
RT1XL	STRAIGHT	22.00"
RT1L	STRAIGHT	12.00"
RTR-1L	RIGHT ANGLE	12.00"
RTR-1XL	RIGHT ANGLE	22.00"
RT1S	STRAIGHT	6.00"
RT1SS	STRAIGHT	3.75"
<b>RTC-1L (INSULATED)</b>		
	STRAIGHT	12.00"
<b>TPS, TCM, TRS, TTM</b>		
RT4L	STRAIGHT	12.00"
RT4S	STRAIGHT	6.00"
<b>RTC-4L (INSULATED)</b>		
	STRAIGHT	12.00"
<b>TRC, TRN</b>		
RT5XL	STRAIGHT	23.25"
RT5L	STRAIGHT	13.25"
RT5S	STRAIGHT	7.25"

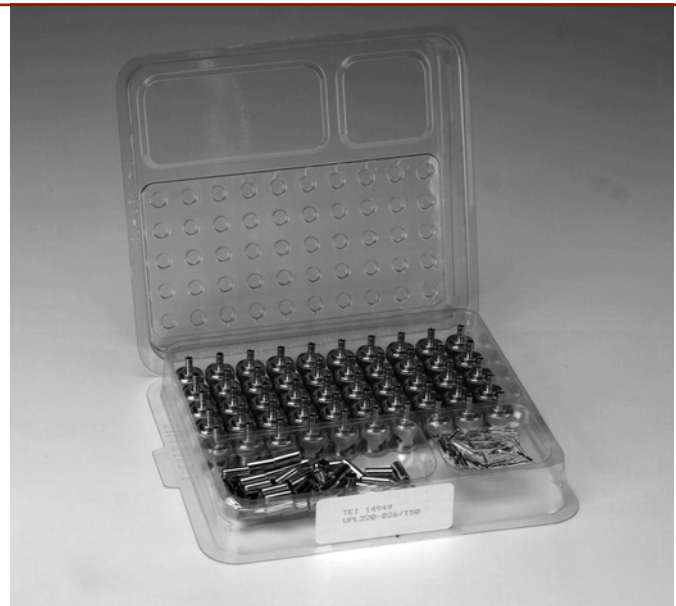

### BNC Bulk Packaging

Bulk packaging for UPL220 Series BNC plugs ... Trompeter offers Tool Crimp BNC's bulk packed in convenient vacuum-formed plastic trays. Bulk packaging is perfect for OEM and high-volume, on-site installations.

#### Includes:

- (50) Body Assemblies
- (51) Crimp Sleeves
- (52) Center Contact Pins
- Assembly Instructions

Example: **UPL220-026/T50**

BNC part number

Vacuum Tray part number

For cable groups see pages 82-124.

(Not available for cable groups -017)

### BNC Coax Assembly Training Video

Trompeter has produced a video which outlines the major features of our BNC design, describes the tools for reliable installation, and gives step-by-step assembly instructions. The BNC Assembly Video is available in VHS format or CD at *no cost* to Trompeter Customers; also available online at [www.trompeter.com](http://www.trompeter.com)

- For additional information or for a free demonstration, contact your local Sales Representative located on the inside back cover of this catalog or you can log on to our web site at <http://www.trompeter.com> and locate the rep nearest you.



## TROMPETER CABLE SPECIFICATIONS

### Trompeter Cable Specs

Trompeter cables are manufactured to the listed specifications and offer optimum flexibility, shielding, and performance. Cables with stranded center conductors have greater flexibility and are recommended for short runs at low frequency where constant cable movement might fatigue a single copper-weld center conductor. Trompeter's **M17/176-00002** and **TWAC-78-1F2** are 200°C, Hi-Temp Cables for MIL-STD-1553B data bus applications. Dielectric and fillers made of PTFE (Teflon™) and outer jackets are PFA (Perfluoroalkoxy). All dimensions are in inches. All values without tolerances are *nominal* unless otherwise stated. **TWCH-78-2** has jacket constructed of *flame retardant halogen free polyolefin* with temperature range of -30°C to +80°C.

**TWCP** = Twinax Plenum Cable

**TWCH** = Twinax Blue Flame Retardant Halogen Free Polyolefin Cable

**TRCH** = Triax Yellow Flame Retardant Halogen Free Polyolefin Cable

### Coax Cable Specs

COAX			
Cable Designation	TCC-50-2	TCC-75-2	RG62 A/U
Impedance (Ohms)	50±2	75±3	93±5
Nominal outer dia.	0.195	0.242	0.242
PVC outer	Green	Violet	Black
Braid outer dia.	0.150 Max	0.191 Max	0.191 Max
Braid AWG#/Mat'l	36/Tinned Cu	34/Bare Cu	34/Bare Cu
Dielectric outer dia.	0.116	0.146	0.146
Dielectric mat'l	Solid PE	Foamed PE	PE
Conductor outer dia.	0.0355	0.031	0.0253
Conductor strands/Mat'l	19/.0071 Tinned Cu	7/.010 Tinned Cu	Solid/CCS
Operating temperature range	-40°C to +90°C	-40°C to 85°C	-40°C to 80°C
Minimum bend radius	1.00	1.00	
Max. Opr. VAC (RMS)	1.4 KV	800 V	750 V
Capacitance pf/ft (Max)	30.8	17.3	14.5
Cond. Loop Res. (Ohms/M ft.)		17.6	
<b>Atten. dB/100 ft:</b>			
1 MHz	0.380	0.335	0.250
10 MHz	1.400	1.070	0.900
50 MHz	3.40	2.40	1.90
100 MHz	4.90	3.40	2.80
200 MHz	7.30	4.85	3.70
400 MHz		9.00	5.20
1 GHz	28.80	12.00	8.50
3 GHz		30.00	
Shielded Coverage	93%	93%	94.3% Min

For high temperature cables, see chart on the next page.

### Exploded Detail of Coax, Twinax, & Triax Cable

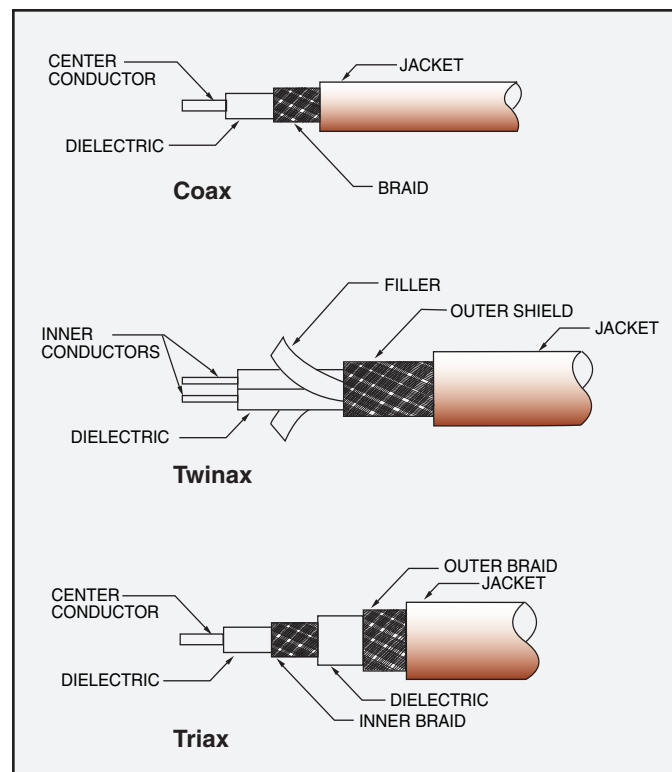

# TROMPETER CABLE SPECIFICATIONS

## Twinax/Triax Cable Specs

Cable Designation	TWINAX						TRIAx			
	TWC-78-1	TWC-78-2	HIGH TEMP:		TWC-124-1A	TWC-124-2	TRC-50-1	TRC-50-2	TRC-75-1	TRC-75-2
			M17/176-00002	TWAC-78-1F2						
Impedance (Ohms)	78±3	78±3	77±7	77±7	124±4	124±4	50±2	50±2	75±5	75±5
Nominal outer dia.	0.150	0.242	0.129	0.095	0.150	0.245	0.156	0.245	0.189	0.245
Outer braid dia.	0.108	0.195 Max	0.102	0.070	0.105	0.195 Max	0.121	0.210 Max	0.150	0.205
Core outer dia.	0.085	0.154	0.084	0.052	0.085	0.162				
Dielectric outer dia.	0.043	0.076	0.042	0.026	0.043	0.080	0.047	0.116	0.073	0.116
Inner braid outer dia.							0.069 Max	0.146 Max	0.093	0.146 Max
Inner jacket outer dia.							0.101	0.175	0.130	0.175
Conductor outer dia.	.022	0.0370	0.0230 Min.	0.0149	0.0120	0.0220	0.0150	0.0370	0.0120	.0185
Operating temperature Range	-40°C to 80°C	-40°C to 80°C	-55°C to +200°C	-55°C to +200°C	-40°C to +80°C	-40°C to +80°C	-40°C to +75°C	-40°C to +80°C	-40°C to +80°C	-40°C to +80°C
Minimum bend radius (in.)	1.50 Max	1.25	1.50	1.25	1.50	1.25	0.75	1.25	1.00	1.25
Max. Opr. VDC	0.6 KV Max	2.0 KV			0.6 KV	2.0 KV	2.0 KV	6.0 KV	2.0 KV	6.0 KV Max
Max. Opr. VAC (RMS)	0.3 KV Max	1.0 KV	750 KV Max	250	0.3 KV	1.0 KV	1.0 KV	2.0 KV	1.0 KV	2.0 KV Max
Capacitance pf/ft. (Max)	20.30 Max (2)	21.20 (3)	24.00	23.00	12.40	12.30 (3)	29.50	32.00 (1)	20.00	20.50 (1)
Cond. loop res. (Ohms/M ft.)	179 Max	19.00 Max	48.00	146.00	570.60	56.80 Max				
<b>Atten. dB/100 ft.:</b>										
1 MHz	2.000	0.700	1.400	2.000	3.250	0.540	2.800	0.500	0.900	0.480
3 MHz	3.000	1.100	2.100		4.400	0.920	3.100	0.800	1.300	0.880
4 MHz	3.500	1.400	2.400		4.800	1.060	3.300	0.900	1.500	1.010
5 MHz	4.000	1.550	2.800		5.200	1.180	3.400	1.100	1.700	1.100
7 MHz	4.500	1.800	3.500		5.600	1.400	3.700	1.300	1.900	1.300
10 MHz	5.300	2.200	4.50 Max	6.500	5.900	1.650	4.100	1.500	2.400	1.500
20 MHz	7.50	3.10			8.30	2.30	5.50	2.30	3.60	2.30
30 MHz	9.20	3.90			10.20	2.80	7.00	2.90	4.50	2.90
40 MHz	10.60	4.50			11.80	3.20	7.50	3.40	5.40	3.30
50 MHz	11.90	5.10			13.20	3.60	9.10	3.90	6.10	3.60
100 MHz	16.80	7.50			18.70	5.10	14.00	5.80	9.70	5.20
200 MHz	23.70	10.50			26.40	7.20	22.00	8.80	16.50	7.60
500 MHz	37.50	16.00			41.70	11.40	40.00	15.30	28.50	10.80
700 MHz	44.30	18.60			49.40	13.50	50.00	18.00	36.00	14.70
1 GHz	53.00	22.50			59.00	16.20	63.00	23.00	45.00	17.60
Shielded coverage	93%	93%	93.3%	90% Min.	93%	93%	93% Min.	93%	93% Min.	93%
Twist per ft.	8.00	4.00	11-14	16.00	8.00	4.00				

## Twinax/Triax: Plenum/Halogen Free Cable Specs

Notes:

- (1) = Center Conductor to Inner Braid
- (2) = Conductor to Shield
- (3) = Conductor to Conductor

Cable Designation	TWINAX						TRIAx
	TWCP-78-1	TWCP-78-2	TWCH-78-2	TWCP-124-2	TWCP-124-3	TWCP-124-5	TRCH-50-2
Description	Plenum	Plenum	Halogen Free	Plenum	Plenum	Plenum	Halogen Free
Impedance (Ohms)	78±3	78±3	78±3	124±4	124±4	124±5	50±2
Nominal outer dia.	0.150	0.242	0.242	0.245	0.205	0.325	0.245
Outer braid dia.	0.102	0.165	0.195	0.183	0.183	0.295	0.210
Core outer dia.			0.154	0.163			
Dielectric outer dia.	0.041	0.072	.076	0.080	0.062	0.134	0.116
Inner braid outer dia.						0.043	0.146
Inner jacket outer dia.							0.175
Conductor outer dia.	0.021	0.037	0.037	0.024	0.024	0.048	0.037
Operating temperature range	+125°C	+125°C	-30°C to +80°C	+125°C	-10°C to +75°C	-10°C to +125°C	-30°C to +80°C
Minimum bend radius (in/ft.)	1.50	2.50	1.25	2.5	2.0	3.25	1.25
Max. Opr. VDC			2KV	2500	2500	2500	6 KV
Max. Opr. VAC (RMS)			1KV	1KV	1800	1800	2 KV
Capacitance pf/ft. (Max)	19.6 (3)	18.6(3)	21.2(3)	11.5	12.0(3)	11.0(3)	
Cond. loop res. (Ohms/M ft.)			19.0	47.0	28.4	6.5(3)	10.5
<b>Atten. dB/100 ft.:</b>							
1 MHz	2.00	.60	0.70	.50	0.60	.30	0.50
3 MHz	3.00	1.00	1.10	.85	0.90	.47	0.80
4 MHz	3.50	1.20	1.40		1.10	.64	0.90
5 MHz	4.00	1.40	1.55	1.10	1.20	.69	1.10
7 MHz	4.50	1.60	1.80	1.30	1.40	.79	1.30
10 MHz	5.30	2.00	2.20	1.60	1.60	.94	1.50
20 MHz	7.50	2.80	3.10	2.30	2.20	1.20	2.30
30 MHz	9.20	3.50	3.90		2.80	1.50	2.90
40 MHz	10.60	4.10	4.50		3.20	1.70	3.40
50 MHz	11.90	4.60	5.10	3.70	3.60	2.00	3.90
100 MHz	16.80	6.90	7.50	5.30	5.20	3.00	5.80
200 MHz	23.70	9.90	10.50		7.20	4.50	8.80
500 MHz	37.50	15.40	16.00		11.40	7.00	15.30
700 MHz	44.30	18.30	18.60		13.50	8.40	18.00
1 GHz	53.00	21.80	22.50		16.20	11.00	23.00
Shielded coverage	97%	95%	93%	93%	93%	93%	93%
Twist per ft.	8.0	4.0	4.0	4.0	6.0	6.0	



# TROMPETER GENERAL MATERIAL/FINISH SPECIFICATIONS

## TFS-1: Finish Specifications

<b>TFS-1A</b> .0001- .0003 max thk <b>Bright Nickel</b> per QQ-N-290, Class 1, Form SB (over) .000080-.000150 thk <b>Bright Copper</b> per MIL-C-14550 (over) .0005 max <b>Electroless Nickel</b> per AMS-2404C, Class 1 (On Aluminum Only)
<b>TFS-1B</b> .000020 - .000030 thk <b>Bright Gold<sup>2</sup></b> per MIL-G-45204, Type II, Grade C, Class <sup>3</sup> (over) .000050-.000180 thk <b>Bright Nickel<sup>3</sup></b> per QQ-N-290, Class 1 (over) .000080-.000150 thk <b>Bright Copper<sup>3</sup></b> per MIL-C-14550
<b>TFS-1C<sup>3</sup></b> .0003 <b>Watts Nickel</b> per QQ-N-290, Form SB, Class 1 (over) .000010 <b>Nickel</b> per QQ-N-290, Class 1
<b>TFS-1D</b> .0001min - .000120 max thk <b>Electroless Nickel</b> per AMS 2404C (over) .000080 min - .000150 max thk <b>Bright Copper</b> per MIL-C-14550
<b>TFS-1E</b> .0002 min -.0003 max thk <b>Bright Electro Tin</b> per MIL-T-10727, Type 1 and solder test per Para. 4.6.3.1
<b>TFS-1E2</b> .0002 min -.0003 max thk <b>Bright Electro Tin</b> per MIL-T-10727, Type 1, and Solder Test per Para.4.6.3.1 (over) .000080 min - .000150 max thk <b>Bright copper</b> per MIL-C-14550
<b>TFS-1F<sup>3</sup></b> .000020 min - .000030 max thk <b>Bright Gold</b> per MIL-G-45204, Type II, Grade C, Class 00 (over) .000080 min- .000150 max thk <b>Bright Copper</b> per MIL-C-14550 (over) .000050 <b>Nickel Strike</b> per QQ-N-290, Class 1
<b>TFS-1G</b> .000020 min - .000030 max thk <b>Bright Gold</b> per MIL-G-45024, Type II, Grade C, Class 00
<b>TFS-1H</b> .0002 min - .0003 max thk <b>Cadmium plate</b> per QQ-P-416, Type II, (supplementary chromate treatment, golden iridescent), Class 3
<b>TFS-1M<sup>4</sup></b> .000200 min - .000300 max thk <b>Silver</b> per QQ-S-365, Type II (Semi-bright) Grade A (Chromate post treatment) (over) .000080 min - .000150 max thk <b>Bright Copper</b> per MIL-C-14550
<b>TFS-1N<sup>5</sup></b> .0003 - .0005 thk <b>Cadmium plate</b> per QQ-P-416, Class 2, Type II, Olive Drab (over) .0005 -.000550 thk <b>Electroless Nickel plate</b> per AMS 2404C
<b>TFS-1P<sup>3</sup></b> 1 .00010 min - .00012 max. thk <b>Bright Gold</b> per Mil-G-45204, Type II, Grade C, Class 2 2 .000050 min - .000070 max. thk <b>Bright Gold</b> per Mil-G-45204, Type II, Grade C, Class 1 3 .000020 min - .000030 max. thk <b>Bright Gold</b> per Mil-G-45204, Type II, Grade C, Class 00 (over) .00010 min - .000150 max. thk <b>Bright Copper</b> per Mil-C-14550
<b>TFS-1R1</b> .00010 min-.00012 max thk <b>Bright Gold</b> per MIL-G-45204, Type II, Grade C, Class 2 (over) .000010 min-.000015 max thk <b>Bright Gold Strike</b> per MIL-G-45204, Type 1, Grade A, (over) .00010 min-.00015 max thk <b>Bright Copper</b> per MIL-C-14550, Class 4

<b>TFS-1T<sup>5</sup></b> .000050 - .000100 <b>Bright Tin</b> per MIL-T-10727, Type I (Electro Deposited) (over) .000150-.00020 <b>Sulfamate Nickel</b> per MIL-P-27418 (over) .00010-.000150 <b>Copper</b> per MIL-C-14550, Class 4
<b>TFS-1U<sup>5</sup></b> .000200-.00030 thk <b>Sulfamate Nickel</b> per MIL-P-27418 (over) .000080-.000150 max thk <b>Copper</b> per MIL-C-14550
<b>TFS-1V<sup>3</sup></b> .000200-.000300 max thk <b>Silver</b> per QQ-S-365, Type I (Matte), Grade A (over) .000050-.000180 max thk <b>Sulfamate Nickel</b> per MIL-P-27418, (over) .000080 min-.000150 max thk <b>Bright Copper</b> per MIL-C-14550
<b>TFS-1W</b> .00020 min-.00030 max thk <b>Cadmium Plate</b> per QQ-P-416, Type II Olive Drab, Class (over) .00020 min- .00030 max thk <b>Sulfamate Nickel</b> per MIL-P-27418 (over) .000080 min- .000150 max thk <b>Copper</b> per MIL-C-14550
<b>TFS-1X</b> .0002-.0003 thk <b>Nickel</b> per QQ-N-290, Class 1, Form SB Grade G (over) .000080 min-.000150 max <b>Bright Cooper</b> per MIL-C-14550

## Trompeter Finish Specification -1 (TFS-1) Notes:

- (2) Bright Gold plate on all connector center contacts, pins, sockets, shall be .000050 min - .000070 max thk, Class 1
- (3) Thickness is in accordance with MIL-G-45204B, Para 6.3 "Strikes and Underplating"
- (4) Copper Alloy articles on which a nickel undercoat is not used shall not be used for continuous service at temperatures above 149°C (300°F) QQ-S-365, Para. 3.3.5.
- (5) For use on Brass and Beryllium Copper body (shell) and accessory components when 500 hour salt spray test is specified. (For test conditions, refer to MIL-C-38999, Para. 3.16 and 4.7.12.2, [Method 1001.1 of MIL-STD-1344])
- (6) Plating thickness variations, critical and noncritical areas must be plated to within specified lower limits, except where surfaces cannot be contacted by A .75 inch dia ball, noncritical areas total plating thickness may exceed the specified upper limits by .000150 maximum.

Materials	Alloy or Type	FED/MIL Spec.	Usage
ABS	Moldings Type 2	MIL-STD-1803 L-P-1883B	Looping plug handles, lock pins
Acetal	Dupont Delrin	L-P-392	Insulators, cases, bushings
Aluminum	2024-T351	QQ-A255/6	Backbars, cases
	6061-T6	QQ-A200/8	Stiffener bars
	6061-T6	QQ-A250/11	Patch panels
	6061-T6511	QQ-A200/8	Backbars, cases
Beryllium Copper	17200 (Bar)	ASTM-B-194	Contact & crescent springs
	17300 (Flat)	ASTM-B-196 & 197	Contact sockets, fingers/springs, washers
Brass	C26000	ASTM-B-36	Ground lugs, washers
	C36000	ASTM-B-16	Connector bodies, coupling sleeves, clamp nuts, hex mtg. nuts, ctr. contact pins, cases
			Moldings
Dupont Acetal Resin #500TL	Homopolymer General Purpose w/ 1.5% Teflon Micropowder		
Fluorinated Ethylene Propylene	(FEP)	ASTM-D-2116	Insulators
Hylfon	MFA Grade 640		Alternate material dielectric
Loctite	495 (Zinc Iridite per ASTM-B633)	QQ-2-325 Type 2 Class 2 Finish	
Nylon	6/6 or 6/12	L-P-410A	Insulating bushings
Perfluoroalkoxy (PFA)		ASTM-D-3307	Cable jackets
Phenolic	XXX	L-P-513 PBE	Patch panels, backbars
Phosphor Bronze	Alloy 544	ASTM-B-139	Contact springs, lockwashers
Polytetrafluoroethylene	(PTFE)	ASTM-D-1710	Dielectrics, insulators
Polyvinylidene Fluoride		MIL-I-23053/8	Sealing Sleeves
Rubber	Silicone	ZZ-R-765	Gaskets, O-rings, sealing members
Solder	Sn60, 62, 63, or 96	QQ-S-571	
Steel	C1010-1018	QQ-S-636	MPN cases
	Music Wire	ASTM-A228 SAE J178	Tension springs
Steel CRS	Type 17-4PH	AMS-5643 Tubing	
Corrosion Resistant Steel	303	QQ-S-763	Connector bodies, coupling sleeves, hex mtg. nuts
	302	QQ-S-766	Designation strips
	301	ASTM-484, A582	
Thermo-plastic Polyester	Glass Filled	MIL-M-24519	Heat resistant molded insulators
Vinyl	Clear Rigid-Self ext.	ASTM-D-635	Designation strip window
	Opaque Rigid-Self ext.	ASTM-D-635	Designation strip marking strip
Zinc	Alloy #3	ASTM-B-240/B-86	Selected non-functional parts

TFS = Trompeter Finish Specifications

Frequency Range	Connectors					Patching		
	BNC	TNC	70 Series	150 Series	450 Series	WE Standard	WE Miniature	RCA Standard
	0-4 GHz	0-11 GHz	0-500 MHz	0-500 MHz	0-2 MHz	0-1 GHz	0-1 GHz	0-200 MHz
VSWR	1.30 Max.				Not Rated	1.04 @ 75 MHz 1.12 @ 100 MHz 1.18 @ 500 MHz	1.06 Max. - -	1.05 @ 50 MHz 1.09 @ 100 MHz 1.33 @ 500 MHz
Voltage Rating	500 VRMS @ Sea Level	500 VRMS @ Sea Level	400 VRMS @ Sea Level	250 VRMS @ Sea Level	150 VRMS @ Sea Level	500 VRMS @ Sea Level	250 VRMS @ Sea Level	500 VRMS @ Sea Level
	125 VRMS @ 70,000 ft.	125 VRMS @ 70,000 ft.	100 VRMS @ 70,000 ft.	62.5 VRMS @ 70,000 ft.	Not Rated	Not Rated		
Temperature Range	-65°C to 165°C			-65°C to 200°C	-65°C to 165°C	-65°C to 165°C		

## BNC TOOL/WRENCH CRIMP ASSEMBLY ILLUSTRATIONS

### BNC Coax Tool Crimp Assembly Illustration

#### Step 1

1. Place crimp sleeve onto cable with the step located away from the cut end as shown.
2. Strip cable as shown and flare braid.
3. On connectors with cable group number -001 thru -007, and -027 only, slide filler sleeve fully under braid, then bushing under cable dielectric.
4. Crimp contact pin in position shown.

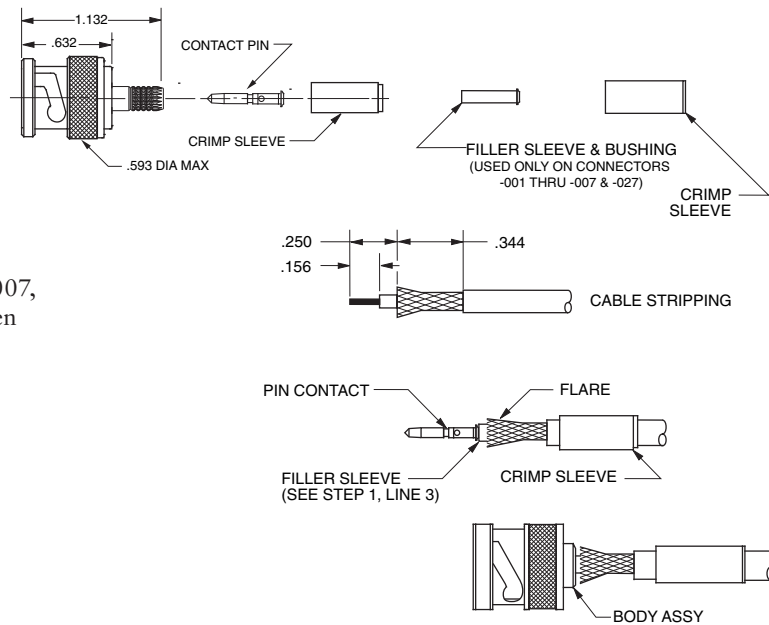

#### Step 2

1. Push cable assembly into the body until the contact pin snaps into place.
2. Slide crimp sleeve forward over braid, up against the body assembly and crimp in place.

### BNC Coax Wrench Crimp Assembly Illustration

#### Step 1

1. Place clamp nut onto cable.
2. Strip cable as shown and flare braid to allow free entry of cone (Lateral slits 180° apart may be required for very inflexible jacket materials).
3. Lightly tin center conductor (optional).

#### Step 2

1. Push edge of cone between cable dielectric and braid (or between foil and braid, if foil is present, and cone I.D. will accept it). Continue to push cable into cone until cable dielectric bottoms against cone dielectric. Center conductor should be visible in pin inspection hole.
2. Solder center conductor into pin.

#### Step 3

1. Bring clamp nut up onto tapered portion of cable.
2. Assemble body and engage with clamp nut.
3. Wrench tighten to 25-30 inch-pounds torque.

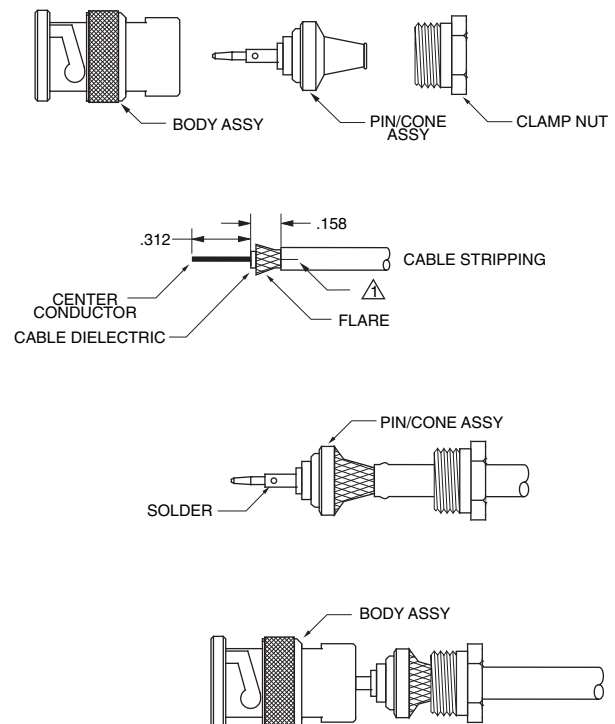

Notes: For illustration purposes only. Not intended to replace actual installation instructions.

# CABLE GROUP TABLE NOTES BEND RELIEF BOOTS/SPRINGS

## Cable Group Table Notes

If your cable group is not listed, contact the factory for assistance...

Trompeter provides cable connectors with configurations designed to provide tough, durable terminations on specific cables. Cable connector part numbers reference a specific cable group number for a specific cable type, model, and/or manufacturer. This *ensures* that the connector fits your cable and provides the toughest termination available in the industry.

If you know the part number and manufacturer of your cable, you can locate the cable's assigned cable group number using the cable group table in the following pages.

- If you have a Trompeter connector, you can determine the cable group number by the last hyphenated suffix, (usually 1 to 3 digits).

Example: **UPL220-026 = cable group number -026**

**Note:** All dimensions in the proceeding Cable Group Table are in thousandths of an inch.

- If you cannot satisfy your connector requirements with the standard cable group number, or have a special requirement, contact your local Trompeter representative listed on the back inside cover of this catalog, or you can visit our website at [www.trompeter.com](http://www.trompeter.com) to find the sales rep nearest you. Contact the factory for more information.

**Note:** Cables of the same type and specification may vary from manufacturer to manufacturer. Always verify the cable group number for your connector type and manufacturer.

The symbol  $\triangle$  after the part numbers listed in this catalog indicates that you should refer to the cable group table in the proceeding pages.

Wrench style = **Wrench Crimp**  
Crimp style = **Tool Crimp**

## Bend Relief Boots/Springs



Minimizes the cable damage when exceeding the cable's minimum bend radius. Bend relief boots are made of tough 105°PVC. Bend relief springs are *plastic coated tempered steel wire* which are assembled as an integral part of the clamp-nut assembly. Available for specific Trompeter connectors, patch cords, and cable assemblies. For bend relief "BR" spring connectors, refer to page 79. Boots may be assembled to the cable connector using **3M ScotchGrip™ No.1099** plastic adhesive or equivalent. Call the factory for availability.

For Plugs: (PL20, PL40) Wrench Crimp Connectors (Cable Groups -1, -2, & -5 only)	Black	<b>ACA-</b> $\triangle$ -0
For Plugs: (PL220 & PL240) Tool Crimp Connectors (Cable Groups -011 & -013 only)	Clear	<b>ACC-</b> $\triangle$

## CABLE GROUP TABLE

CABLE MANUFACTURER	CABLE NUMBER	CABLE TYPE	WRENCH STYLE	CRIMP STYLE	JACKET SIZE	CONDUCTOR	IMPEDANCE
3M	SCI 041	COAX	-44	*	0.074	0.012	75
ACD CABLE	4-27046-3265	TWINAX	*	_	0.194	0.024	_
ACOME	MC7539	COAX	-22	-009	0.151	0.020	_
AEROSPACE	4114	COAX	SEE COMMENTS	TOO LARGE	0.345	0.064	_
AEROSPACE INDUSTRIES INC	90149	COAX	*	*	0.194	0.030	_
AEROSPACE WIRE	4080	COAX	*	_	0.348	0.102	50
ALCATEL	0960 WL	COAX	_	-004	0.093	0.011	75
ALCATEL	ASNE 0690 WL	COAX	_	-004	0.093	0.011	75
ALCATEL	CDE 003	TWINAX	*	-204	0.140	0.024	77
ALPHA	7632	TWINAX	*	_	0.169	0.030	600V
ALPHA	8620	COAX	-41	-020	0.270	0.041	75
ALPHA	9059	COAX	-2	-013	0.242	0.026	75
ALPHA	9102	COAX	*	-023	0.212	0.032	75
ALPHA	9108	TWINAX	-55	*	0.210	0.038	78
ALPHA	9109	TWINAX	_	-213	0.252	0.037	100
ALPHA	9158	COAX	-21	*	0.165	0.035	53
ALPHA	9159	COAX	*	*	0.188	0.023	75
ALPHA	9174	COAX	-5	-003	0.100	0.021	50
ALPHA	9316	COAX	-5	-003	0.098	0.021	50
ALPHA	9807	COAX	-51	-016	0.304	0.032	75
ALPHA	9817	TWINAX	-8	_	0.327	0.038	100
ALPHA	9830	COAX	-2	-013	0.242	0.025	75
ALPHA	9840	COAX	-2	-013	0.240	0.025	80
ALPHA	9847	COAX	_	-053	0.405	0.064	75
ALPHA	9850	TRIAx	-13	TOO LARGE	0.314	0.032	75
ALPHA	9858	COAX	-1	-011	0.193	0.036	50
ALPHA	2827/2	TWINAX	-29	-207	0.120	0.037	600V
ALPHA	2834/2	TWINAX	-45	_	0.137	0.032	600V
ALPHA	2837/2	TWINAX	*	*	0.156	0.038	600V
ALPHA	9058C	COAX	-1	-011	0.194	0.038	50
ALPHA	9179B	COAX	-5	-004	0.101	0.012	75
ALPHA	9180B	COAX	-4	*	0.140	0.038	95
ALPHA	9187A	COAX	-36	-004	0.105	0.010	75
ALPHA	9196A	COAX	-44	-1	0.070	0.011	50
ALPHA	9804C	COAX	-41	-020	0.275	0.040	75
ALPHA	9814C	TWINAX	*	-213	0.244	0.038	75
ALPHA	9818C	TWINAX	-8	_	0.330	0.037	100
ALPHA	9825C	COAX	-6A	_	0.400	0.064	75
ALPHA	9851C	COAX	*	_	0.405	0.086	50
ALPHA	9861C	COAX	-1	-011	0.192	0.038	_
ALPHA	9871F	COAX	*	-011	0.182	0.037	50
ALPHA WIRE	2821/2	TWINAX	-27	_	0.138	0.024	600V
AMDAHL	215-9000-000	COAX	-5A	-001	0.075	0.012	_
AMPEX	616-569	COAX	-36	*	0.110	0.015	_

Note: \* = Special contact factory



# CABLE GROUP TABLE

CABLE MANUFACTURER	CABLE NUMBER	CABLE TYPE	WRENCH STYLE	CRIMP STYLE	JACKET SIZE	CONDUCTOR	IMPEDANCE
AMPHENOL	82-5588	TWINAX	-8	—	0.330	00.39	—
AMPHENOL CNDA	21-1060	COAX	-6	-016	—	—	—
AMPHENOL CNDA	621-446-795	COAX	-6	—	—	—	—
ANDREW	FSJ2-50B	COAX	*	—	—	—	50
ANDREW	HJ4-50	COAX	*	—	—	—	50
ANDREW	HJ5-50	COAX	*	—	—	—	50
ANDREW	LDF2-50-A	COAX	*	—	—	—	50
ANDREW	LDF4-50-A	COAX	*	TOO LARGE	0.630	0.189	50
ANDREW	LDF5-50-A	COAX	*	—	—	—	50
ANIXTER	9L759586	COAX	—	*	0.280	0.042	—
ANIXTER COLUMBIA	55	COAX	*	*	0.143	0.012	—
ANTENNA SPECIALISTS	18-73-2	COAX	-52	—	0.246	0.052	50
ARGOSY	8DV75	COAX	-21	*	0.170	0.024	75
ARINC	629	TWINAX	-8	TOO LARGE	0.313	0.036	—
ASTROLAB	32001	COAX	-5	*	0.115	0.020	—
ASTROLABS	32081	COAX	-5	-003	0.100	0.020	50
ASTRONAUTICS	169450	TRIAX	-7	—	0.210	0.023	—
AT&T (LUCENT)	733	COAX	—	-027	—	—	75
AT&T (LUCENT)	1735A	COAX	—	-026	0.128	0.016	75
AT&T (LUCENT)	2734A	COAX	—	*	0.225	0.032	75
AT&T (LUCENT)	2735A	COAX	-22	-026	0.140	0.015	75
AT&T (LUCENT)	734D	COAX	-63	-025	0.236	0.031	75
AT&T (LUCENT)	735A	COAX	*	-026	0.125	0.016	75
AT&T (LUCENT)	NSI 4609 805 13019	COAX	-37	*	0.166	0.016	—
AT&T(LUCENT)	724	COAX	-6	-016	0.304	0.033	—
AT&T(LUCENT)	728	COAX	-6	-016	0.304	0.033	75
AT&T(LUCENT)	731	COAX	-2	-015	0.248	0.023	75
AT&T(LUCENT)	730A	COAX	-2B	-015	0.255	0.025	—
AT&T(LUCENT)	734A	COAX	-63	-025	0.236	0.031	75
AT&T(LUCENT)	KS-19224L2	COAX	-31	*	0.116	0.011	—
AT&T(W.E.CO)	16PEVL	TWINAX	-12	—	0.460	0.051	—
AT&T(W.E.CO)	754E	TWINAX	-10	—	0.420	0.040	—
AT&T(W.E.CO)	760A	TWINAX	-11	TOO LARGE	0.308	0.025	—
AT&T(W.E.CO)	761A	TWINAX	-30	—	0.215	0.021	—
AT&T/NSI	4609 805 13019	COAX	—	*	—	—	—
ATLAS	1405-59-U95	COAX	-2	-014	0.242	0.032	75
AVAYA	1725B	COAX	*	-054	0.325	0.050	75
AXON	A3331B	TRIAX	—	*	0.215	0.020	—
AXON	CC6297	TWINAX	-55	—	0.205	0.024	124
AXON	P502805C	TWINAX	*	-201	0.126	0.024	—
AXON	P502810	TWINAX	-47	-201	0.135	—	77
AXON	P506133	TRIAX	*	—	0.213	0.025	75
AXON	P506425	TWINAX	-55	—	0.202	0.025	120
AXON	P507991A	TWINAX	*	-204	0.134	0.024	—

Note: \* = Special contact factory

## CABLE GROUP TABLE

CABLE MANUFACTURER	CABLE NUMBER	CABLE TYPE	WRENCH STYLE	CRIMP STYLE	JACKET SIZE	CONDUCTOR	IMPEDANCE
AXON	P512806	TWINAX	*	-217	0.150	0.024	—
AXON	P512807	TWINAX	*	-217	0.152	0.024	—
AXON	P813856	TRIAx	—	*	0.192	0.024	—
AXON	S9702211	TRIAx	*	*	0.197	0.024	—
AXON	SRX 50 C	TRIAx	*	—	—	—	—
AXON	SSTHE2-H1	TWINAX	—	-222	0.151	0.025	—
AXON	UKT2407-SPC-HSTP-2	TWIAx	*	-223	0.114	0.024	50
BEDEA	TRIAx 11	TRIAx	*	TOO LARGE	0.438	0.055	75
BELDEN	8208	TWINAX	-25	—	0.257	0.047	300V
BELDEN	8212	COAX	-2	-014	0.242	0.032	75
BELDEN	8213	COAX	-6A	-053	0.405	0.064	75
BELDEN	8214	COAX	*	TOO LARGE	0.403	0.108	50
BELDEN	8215	COAX	-6E	-017	0.332	0.028	75
BELDEN	8216	COAX	-5	-003	0.103	0.020	50
BELDEN	8218	COAX	-22	-009	0.150	0.017	75
BELDEN	8219	COAX	-1	-011	0.195	0.037	52
BELDEN	8221	COAX	-2	-013	0.242	0.025	80
BELDEN	8227	TWINAX	-8	—	0.330	0.039	—
BELDEN	8232	TRIAx	-13A	TOO LARGE	0.312	0.032	75
BELDEN	8233	TRIAx	-14	—	0.475	0.064	75
BELDEN	8237	COAX	-6A	—	0.405	0.085	50
BELDEN	8238	COAX	-6A	—	0.405	0.048	75
BELDEN	8240	COAX	-1	-021	0.195	0.032	51.5
BELDEN	8241	COAX	-2	-013	0.242	0.025	75
BELDEN	8259	COAX	-1	-011	0.195	0.040	50
BELDEN	8261	COAX	-6A	—	0.405	0.049	75
BELDEN	8262	COAX	-1	-011	0.192	0.038	50
BELDEN	8263	COAX	-2	-013	0.242	0.023	75
BELDEN	8267	COAX	-6A	—	0.405	0.086	50
BELDEN	8268	COAX	-6B	TOO LARGE	0.425	0.089	50
BELDEN	8279	COAX	-2A	-022	0.220	0.025	75
BELDEN	8281	COAX	-6	-016	0.307	0.030	75
BELDEN	8422	TWINAX	-9	—	0.231	0.025	1000V
BELDEN	8441	TWP	30	—	0.210	0.025	300V
BELDEN	8450	TWINAX	-27	—	0.121	0.025	200V
BELDEN	8451	TWINAX	-23	-210	0.140	0.031	300V
BELDEN	8998	COAX	*	*	0.198	0.032	—
BELDEN	9011	COAX	-6A	-053	0.405	0.064	75
BELDEN	9054	COAX	-2	-014	0.242	0.032	75
BELDEN	9060	COAX	-41	*	0.284	0.040	75
BELDEN	9064	COAX	-6A	—	0.400	0.064	75
BELDEN	9066	COAX	-41	-020	0.275	0.041	75
BELDEN	9068	COAX	-22	-009	0.146	0.016	75
BELDEN	9100	COAX	-2	-014	0.237	0.032	75

Note: \* = Special contact factory

# CABLE GROUP TABLE

CABLE MANUFACTURER	CABLE NUMBER	CABLE TYPE	WRENCH STYLE	CRIMP STYLE	JACKET SIZE	CONDUCTOR	IMPEDANCE
BELDEN	9104	COAX	-2A	*	0.243	0.032	75
BELDEN	9108	COAX	*	-014	0.237	0.032	75
BELDEN	9110	COAX	-2	-014	0.242	0.032	75
BELDEN	9112	COAX	-2		0.242	0.032	—
BELDEN	9114	COAX	-41	-020	0.270	0.040	75
BELDEN	9116	COAX	-41	-020	0.278	0.038	75
BELDEN	9141	COAX	-6	-016	0.304	0.033	75
BELDEN	9146	COAX	4	—	—	—	—
BELDEN	9165	COAX	-2	-013A	0.242	0.030	75
BELDEN	9167	COAX	-2	-014	0.243	0.032	75
BELDEN	9168	COAX	-41	-020	0.275	0.040	75
BELDEN	9169	COAX	-2B	-015	0.249	0.025	93
BELDEN	9170	COAX	-4	*	0.140	0.022	75
BELDEN	9171	COAX	-2	-013A	0.242	0.030	75
BELDEN	9182	TWINAX	*	TOO LARGE	0.350	0.031	150
BELDEN	9192	TRIAx	*	—	—	—	75
BELDEN	9201	COAX	-1	-021	0.193	0.033	52
BELDEN	9203	COAX	-1	-021	0.195	0.035	50
BELDEN	9204	COAX	—	-013	0.241	0.025	75
BELDEN	9207	TWINAX	-8	—	0.330	0.039	100
BELDEN	9209	COAX	-63	-019	0.226	0.022	75
BELDEN	9212	COAX	-6A	—	0.405	0.048	75
BELDEN	9221	COAX	-5	-004	0.102	0.012	75
BELDEN	9222	TRIAx	-7	-306	0.239	0.040	50
BELDEN	9223	COAX	-1	*	0.195	0.030	50
BELDEN	9228	COAX	-2	-013	0.242	0.025	93
BELDEN	9231	COAX	-6	-016	0.304	0.032	75
BELDEN	9232	TRIAx	*	TOO LARGE	—	—	75
BELDEN	9239	COAX	-5	-003	0.104	0.019	50
BELDEN	9240	COAX	-2	-014	0.241	0.032	75
BELDEN	9243	COAX	-2	-014	0.242	0.032	—
BELDEN	9244	COAX	-2	-013	0.242	0.025	73
BELDEN	9248	COAX	-41	-020	0.270	0.036	75
BELDEN	9250	TWINAX	-10	—	0.420	0.046	95
BELDEN	9251	COAX	-6A	—	0.405	0.085	52
BELDEN	9252	COAX	*	-010	0.160	0.030	50
BELDEN	9254	COAX	-22	-009	0.142	0.019	75
BELDEN	9258	COAX	*	—	0.247	0.055	50
BELDEN	9259	COAX	-2A	-023	0.234	0.030	75
BELDEN	9265	COAX	-2	-014	0.242	0.031	75
BELDEN	9266	COAX	-2	-013A	0.245	0.031	—
BELDEN	9267	TRIAx	*	*	0.360	0.032	75
BELDEN	9268	COAX	*	-018	0.260	0.025	93
BELDEN	9271	TWINAX	*	—	0.243	0.020	124

Note: \* = Special contact factory

## CABLE GROUP TABLE

CABLE MANUFACTURER	CABLE NUMBER	CABLE TYPE	WRENCH STYLE	CRIMP STYLE	JACKET SIZE	CONDUCTOR	IMPEDANCE
BELDEN	9272	TWINAX	-9	-213	0.242	0.037	78
BELDEN	9273	COAX	-3	-012	0.216	0.035	50
BELDEN	9274	COAX	-2	-014	0.242	0.032	75
BELDEN	9275	COAX	-2	-14	0.242	0.032	75
BELDEN	9284	COAX	-41	-020	0.275	0.040	—
BELDEN	9290	COAX	*	*	0.288	0.037	75
BELDEN	9291	COAX	-2	-013	0.242	0.025	80
BELDEN	9292	COAX	-6A	-053	0.405	0.064	75
BELDEN	9310	COAX	*	-011	0.194	0.035	50
BELDEN	9311	COAX	-1	-011	0.193	0.037	52
BELDEN	9386	COAX	-41	-020	0.275	0.040	—
BELDEN	9448	COAX	-2	-013	0.242	0.025	—
BELDEN	9463	TWINAX	-9	-213	0.240	0.037	78
BELDEN	9555	COAX	-2	-013	0.242	0.023	75
BELDEN	9587	COAX	-41	-020	0.275	0.040	75
BELDEN	9589	COAX	-2	—	0.242	0.032	—
BELDEN	9659	COAX	-2	-013A	0.242	0.030	75
BELDEN	9764	COAX	-6A	—	0.405	0.064	75
BELDEN	9815	TWINAX	-8	—	0.330	0.037	100
BELDEN	9841	TWINAX	-9	-215	0.256	0.025	120
BELDEN	9850	COAX	-6B	—	0.425	0.048	75
BELDEN	9857	COAX	-6A	—	0.405	0.025	125
BELDEN	9859	TWINAX	*	-213	0.243	0.038	78
BELDEN	9860	TWINAX	-46	—	0.440	0.051	124
BELDEN	9861	COAX	-6E	—	0.332	0.057	50
BELDEN	9880	COAX	-48	—	0.405	0.086	50
BELDEN	9888	TRIAx	*	—	0.480	0.108	50
BELDEN	9907	COAX	-1	-011	0.185	0.037	50
BELDEN	9913	COAX	*	-050 (90C)	0.411	0.108	50
BELDEN	9914	COAX	*	TOO LARGE	0.405	0.100	50
BELDEN	9999	TWINAX	—	—	0.185	0.030	78
BELDEN	9999	TWINAX	-33	—	0.187	0.030	78
BELDEN	44319	COAX	*	*	0.298	0.042	75
BELDEN	46899	COAX	-1	*	0.199	0.024	75
BELDEN	81553	TWINAX	-47	-201	0.129	0.024	77
BELDEN	82108	COAX	*	*	0.212	0.032	75
BELDEN	82120	COAX	-34	-024	0.244	0.040	75
BELDEN	82121	COAX	-52	-024	0.240	0.040	75
BELDEN	82240	COAX	*	*	0.159	0.032	53.5
BELDEN	82241	COAX	*	*	0.193	0.023	75
BELDEN	82248	COAX	*	*	0.227	0.041	75
BELDEN	82259	COAX	*	*	0.193	0.030	75
BELDEN	82269	COAX	*	*	0.197	0.025	93
BELDEN	82641	TWINAX	*	—	0.106	0.024	48

Note: \* = Special contact factory

# CABLE GROUP TABLE

CABLE MANUFACTURER	CABLE NUMBER	CABLE TYPE	WRENCH STYLE	CRIMP STYLE	JACKET SIZE	CONDUCTOR	IMPEDANCE
BELDEN	82907	COAX	-21	*	0.163	0.036	50
BELDEN	83241	COAX	*	-011	0.187	0.037	50
BELDEN	83242	COAX	-1	-012	0.193	0.039	50
BELDEN	83264	COAX	-5	-004	0.100	0.012	75
BELDEN	83265	COAX	-5A	-011	0.071	0.010	50
BELDEN	83266	COAX	-22	-008	0.141	0.012	95
BELDEN	83267	COAX	-36	-004	0.110	0.012	75
BELDEN	83269	COAX	-5	-003	0.100	0.018	50
BELDEN	83284	COAX	-5	-003	0.100	0.021	50
BELDEN	83303	COAX	-44	—	0.075	0.019	600V
BELDEN	83310	TWINAX	-29	-207	0.120	0.031	
BELDEN	83317	TWINAX	*	-223	0.112	0.019	600V
BELDEN	83318	TWINAX	-29	-204	0.132	0.025	600V
BELDEN	83319	TWINAX	*	-221	0.139	0.032	NC
BELDEN	84142	COAX	-1	-021	0.195	0.037	50
BELDEN	84303	COAX	-21	-011	0.170	0.037	50
BELDEN	86262	COAX	-2A	-022	0.220	0.025	93
BELDEN	87108	COAX	-2A	-023	—	—	—
BELDEN	87120	COAX	-52	-024	0.256	0.040	75
BELDEN	88232	TRIAx	*	*	0.247	0.032	75
BELDEN	88240	COAX	*	*	0.159	0.032	53.5
BELDEN	88241	COAX	*	*	0.193	0.023	75
BELDEN	88281	COAX	-41	*	0.270	0.031	75
BELDEN	89108	COAX	-2A	-023	0.218	0.032	75
BELDEN	89120	COAX	-52	*	0.235	0.041	75
BELDEN	89120	COAX		*	0.234	0.041	75
BELDEN	89162	COAX	-2A	-019	—	—	75
BELDEN	89182	TWINAX	-54		0.307	0.031	150
BELDEN	89207	TWINAX	*	TOO LARGE	0.267	0.039	100
BELDEN	89248	COAX	-52	*	0.222	0.040	75
BELDEN	89259	COAX	*	*	0.192	0.031	75
BELDEN	89269	COAX	-2A	-022	0.222	0.025	93
BELDEN	89272	TWINAX	-55	*	0.220	0.039	78
BELDEN	89292	COAX	*	-052	0.348	0.064	75
BELDEN	89555	COAX	-53	-019	0.230	0.023	75
BELDEN	89880	COAX	-50	—	0.375	0.086	50
BELDEN	89907	COAX	-21 (20/90)	*	0.160	0.037	50
BELDEN	89913	COAX	*	TOO LARGE	0.364	0.108	50
BELDEN	89999	TWINAX	*	—	0.178	0.030	78
BELDEN	92289	COAX	*	*	0.204	0.025	—
BELDEN	513945	COAX	—	-052	0.405	0.064	75
BELDEN	533945	COAX	-41	-020	0.266	0.041	75
BELDEN	543945	COAX	-2A	-023	0.232	0.032	75
BELDEN	549945	COAX	—	-023	0.232	0.032	75

Note: \* = Special contact factory

## CABLE GROUP TABLE

CABLE MANUFACTURER	CABLE NUMBER	CABLE TYPE	WRENCH STYLE	CRIMP STYLE	JACKET SIZE	CONDUCTOR	IMPEDANCE
BELDEN	551945	COAX	_	-023	0.232	0.030	75
BELDEN	568937	COAX	-36	-027	0.123	0.016	75
BELDEN	573945	COAX	-22	-009	0.146	0.018	75
BELDEN	613948	COAX	_	-025	0.348	0.064	75
BELDEN	633938	COAX	_	*	0.233	0.040	75
BELDEN	633948	COAX	*	*	0.228	0.040	75
BELDEN	633948	COAX	_	*	0.228	0.040	75
BELDEN	643948	COAX	*	*	0.193	0.038	75
BELDEN	643948	COAX	_	*	0.193	0.032	75
BELDEN	649948	COAX	_	*	0.199	0.032	75
BELDEN	673948	COAX	*	*	0.146	0.018	75
BELDEN	1151A	COAX	-2	-013A	0.247	0.032	75
BELDEN	1152A	COAX	-41	*	0.280	0.040	75
BELDEN	1153A	COAX	*	_	0.387	0.064	75
BELDEN	1162A	TWINAX	-8	_	0.330	0.037	100
BELDEN	1163A	COAX	-6	-016	_	_	100
BELDEN	1164B	COAX	-22	-009	0.145	0.019	75
BELDEN	1167A	COAX	-22	-009	0.152	0.020	75
BELDEN	1167B	COAX	-22	-009	0.146	0.019	75
BELDEN	1168A	COAX	-141	_	0.141	0.037	_
BELDEN	1186A	COAX	*	*	0.265	0.032	75
BELDEN	1187A	COAX	*	*	0.267	0.032	75
BELDEN	1189A	COAX	*	*	0.298	0.040	75
BELDEN	1223A	COAX	-41	-020	0.275	0.040	75
BELDEN	1263A	COAX	*	-009	0.160	0.021	75
BELDEN	1406B	COAX	-22	-009	0.146	0.019	75
BELDEN	1407B	COAX	-22	-009	0.146	0.019	75
BELDEN	1417B	COAX	_	-009	0.150	0.018	75
BELDEN	1418B	COAX	-22	-009	0.150	0.015	75
BELDEN	1426A	COAX	-2	-014	0.242	0.032	75
BELDEN	1505A	COAX	-2	-025	0.234	0.032	75
BELDEN	1505F	COAX	-2	_	0.242	0.034	75
BELDEN	1506A	COAX	*	*	0.201	0.032	75
BELDEN	1520A	COAX	-5	-004	0.102	0.012	75
BELDEN	1521A	COAX	_	-004	0.560	0.012	75
BELDEN	1522A	COAX	-36	-004	0.107	0.012	75
BELDEN	1523A	COAX	-6A	-053	0.400	0.064	75
BELDEN	1525A	COAX	-6A	TOO LARGE	0.404	0.064	75
BELDEN	1530A	COAX	-41	-020	0.270	0.040	75
BELDEN	1547A	COAX	-41	-020	0.275	0.040	75
BELDEN	1617A	COAX	-6B	TOO LARGE	0.407	0.064	75
BELDEN	1671A	COAX	-86	-003	0.087	0.020	50
BELDEN	1671J	COAX	-31	_	0.127	0.020	50
BELDEN	1672A	COAX	-86	-004	0.087	0.011	75

Note: \* = Special contact factory

# CABLE GROUP TABLE

CABLE MANUFACTURER	CABLE NUMBER	CABLE TYPE	WRENCH STYLE	CRIMP STYLE	JACKET SIZE	CONDUCTOR	IMPEDANCE
BELDEN	1672J	COAX	-31	-027	0.127	0.011	75
BELDEN	1673A	COAX	_	_	0.138	0.036	50
BELDEN	1673J	COAX	*	*	0.178	0.037	50
BELDEN	1694A	COAX	-41	-020	0.282	0.040	75
BELDEN	1695A	COAX	*	*	0.235	0.040	75
BELDEN	1696A	TWINAX	*	-215	0.240	0.031	110
BELDEN	1800A	TWINAX	*	-212	0.184	0.024	110
BELDEN	1800B	TWINAX	*	-212	0.180	0.024	110
BELDEN	1800F	TWINAX	-30	_	0.216	0.024	110
BELDEN	1807A	COAX	-5	-004	0.110	0.012	75
BELDEN	1808A	COAX	-5	-004	0.110	0.012	75
BELDEN	1809A	COAX	-63	-025	0.234	0.032	75
BELDEN	1824A	COAX	*	*	0.200	0.030	75
BELDEN	1825A	COAX	*	*	0.200	0.030	75
BELDEN	1826A	COAX	*	*	0.200	0.030	75
BELDEN	1828A	COAX	-41	-020	0.270	0.040	75
BELDEN	1829A	COAX	-41	-020	0.270	0.040	75
BELDEN	1855A	COAX	*	*	0.159	0.022	75
BELDEN	1856A	TRIAX	*	TOO LARGE	0.363	0.031	75
BELDEN	1857A	TRIAX	*	TOO LARGE	0.360	0.031	75
BELDEN	1858A	TRIAX	*	TOO LARGE	0.520	0.064	75
BELDEN	1859A	TRIAX	*	TOO LARGE	0.420	0.063	_
BELDEN	1865A	COAX	-22	-09	0.152	0.020	75
BELDEN	1880A	TWINAX	*	-212	0.184	0.024	_
BELDEN	3072F	TWINAX	*	*	0.320	0.046	78
BELDEN	3092A	COAX	-51	*	0.298	0.040	75
BELDEN	4-27046-3265	TWINAX	*	_	0.200	0.023	_
BELDEN	5339b5	COAX	_	-020	0.266	0.040	75
BELDEN	5339Q5	COAX	_	-016	0.298	0.040	75
BELDEN	5399B5	COAX	_	-020	0.270	0.040	75
BELDEN	5439Q5	COAX	_	*	0.265	0.032	75
BELDEN	5539Y5	COAX	_	-022	0.232	0.025	93
BELDEN	6139B8	COAX	_	-052	0.348	0.064	75
BELDEN	6339Q8	COAX	_	-024	0.248	0.040	75
BELDEN	6439C8	COAX	_	*	0.199	0.032	75
BELDEN	6439Q8	COAX	_	-023	0.230	0.032	75
BELDEN	6539Y8	COAX	_	*	0.204	0.025	93
BELDEN	734A1P	COAX	_	*	0.213	0.032	75
BELDEN	734D()	COAX	_	-025	_	_	75
BELDEN	734D()T	COAX	_	-025	_	_	75
BELDEN	734D1	COAX	_	-025	0.235	0.032	75
BELDEN	735A()	COAX	*	-026	_	_	75
BELDEN	735A()T	COAX	*	-026	_	_	75
BELDEN	735A1	COAX	*	-026	0.129	0.016	75

Note: \* = Special contact factory



## CABLE GROUP TABLE

CABLE MANUFACTURER	CABLE NUMBER	CABLE TYPE	WRENCH STYLE	CRIMP STYLE	JACKET SIZE	CONDUCTOR	IMPEDANCE
BELDEN	7700A	COAX	-5	-004	0.107	0.012	75
BELDEN	7710A	COAX	-41	-020	0.275	0.040	75
BELDEN	7712A	COAX		*	0.283	0.040	75
BELDEN	7713A	COAX	-41	-020	0.275	0.040	75
BELDEN	7731A	COAX	-6A	-053	0.405	0.064	75
BELDEN	7732A	COAX	*	—	0.356	0.064	75
BELDEN	7733A	COAX	*	TOO LARGE	0.355	0.108	50
BELDEN	7788A	COAX	-4	-009	0.159	0.023	75
BELDEN	7794A	COAX		-023	0.235	0.032	75
BELDEN	7805A	COAX	-5	-003	0.105	0.018	50
BELDEN	7806A	COAX	-1	-011	0.195	0.037	50
BELDEN	7807A	COAX	-1	—	0.195	0.044	50
BELDEN	7808A	COAX	*	*	0.240	0.056	50
BELDEN	7809A	COAX	*	*	0.300	0.070	50
BELDEN	7810A	COAX	*	TOO LARGE	0.405	0.108	50
BELDEN	7810R	COAX	*	—	0.405	0.108	50
BELDEN	7855A	COAX	—	—	0.320	0.051	75
BELDEN	8232A	TRIAX	-13A	TOO LARGE	0.315	0.032	75
BELDEN	8233A	TRIAX	-14	—	0.475	0.048	75
BELDEN	8241A	COAX	-2	-013	0.242	0.025	75
BELDEN	8241B	COAX	-2	-013	0.242	0.023	75
BELDEN	8241F	COAX	-2	-013A	0.242	0.030	75
BELDEN	8281B	COAX	-6	-016	0.307	0.030	75
BELDEN	8281F	COAX	-51	-016	0.300	0.033	75
BELDEN	9062A	COAX	-2	-013	0.242	0.025	93
BELDEN	9104P	COAX	—	*	0.203	0.032	75
BELDEN	9116P	COAX	*	*	0.235	0.040	75
BELDEN	9209A	COAX	-2A	-019	0.220	0.022	75
BELDEN	9269_	COAX	-2	-013	0.242	0.025	93
BELDEN	97300 2802	TWINAX	*	-050	0.94	0.012	—
BELDEN	9913F	COAX	*	-050	0.408	0.108	50
BELDEN	9931F	COAX	*	—	0.405	0.108	50
BELDEN	H 121B	COAX	—	*	0.196	0.032	75
BELDEN	M9100	COAX	-2	-014	0.240	0.032	—
BELDEN	M9815	TWINAX	-8	—	—	—	—
BELDEN	PD7163	COAX		-004	0.100	0.010	75
BELDEN	SS895	COAX	-36	-027	0.123	0.016	75
BELDEN	YM23969	COAX	-34	*	0.244	0.033	—
BELDEN	YQ10474	TWINAX	-25	—	0.268	0.032	—
BELDEN	YQ28763	TWINAX	-55	—	0.200	—	—
BELDEN	YQ40343	COAX	-5	-004	0.95	0.012	75
BELDEN	YQ41416	TRIAX	-10	TOO LARGE	0.410	0.063	75
BELDEN	YQ42857	COAX	*	*	0.199	0.035	75
BELDEN	YQ44343	COAX	—	-009	0.142	0.019	75

Note: \* = Special contact factory

# CABLE GROUP TABLE

CABLE MANUFACTURER	CABLE NUMBER	CABLE TYPE	WRENCH STYLE	CRIMP STYLE	JACKET SIZE	CONDUCTOR	IMPEDANCE
BELDEN	YR-14910	TWINAX	-29	-202	0.150	0.024	78
BELDEN	YR-15161	TWINAX	-29	-	-	-	-
BELDEN	YR16411	TWINAX	-9	-	0.247	0.023	-
BELDEN	YR-19218	TWINAX	-29	-203	0.150	0.012	124
BELDEN	YR23023	COAX	*	-009	0.160	0.020	75
BELDEN	YR23930	COAX	-2	-014	0.242	0.032	75
BELDEN	YR27110	COAX	-22	-009	0.162	0.021	75
BELDEN	YR27543	TWINAX	-27	*	0.117	0.012	-
BELDEN	YR27772	TWINAX	*	-	0.213	0.026	-
BELDEN	YR28296	TWINAX	-	-203	0.162	0.012	-
BELDEN	YR28314	COAX	*	-009	0.162	0.019	75
BELDEN	YR28365	COAX	-2	-013	0.245	0.025	100
BELDEN	YR28764	TWINAX	*	*	0.383	0.037	-
BELDEN	YR39546	TRIAx	*	*	0.370	0.029	75
BELDEN	YR39667	COAX	-22	-009	0.152	0.020	75
BELDEN	YR40974	COAX	-36	-007	0.113	0.012	75
BELDEN	YR41007	COAX	-63	-025	0.235	0.032	75
BELDEN	YR41039	COAX	-22	-009	0.155	0.020	75
BELDEN	YR41679	COAX	-	-014	0.242	0.032	75
BELDEN	YR-44149	COAX	*	*	0.140	0.015	-
BELDEN	YR45056	COAX	*	-026	0.131	0.017	75
BELDEN	YR45301	COAX	*	-026	0.131	0.017	75
BELDEN	YR46359	COAX	-	-023	0.235	0.034	75
BELDEN	YR46400	COAX	-2A	-014	0.242	0.033	75
BELDEN	YR46844	COAX	-	-009	0.155	0.020	75
BELL LABS	G243630-1	COAX	-4	-008	0.155	0.010	-
BELL LABS	G243630-2	COAX	-4	-008	0.155	0.010	-
BERKSHIRE	RG174/U DS	COAX	-31	*	0.125	0.021	50
BERK-TEK	640070	COAX	*	TOO LARGE	0.353	0.064	-
BERK-TEK	BTDC-59D-TT	COAX	-2	-	0.242	0.023	-
BERK-TEK	BTDC-59-TT	COAX	-2	-022	-	-	75
BERK-TEK	BTX-0113-100175	TRIAx	-43	-	0.175	0.011	-
BERK-TEK	E73133	COAX	*	-011	0.185	0.037	-
BERT-TEK	640019	COAX	-50	TOO LARGE	0.375	0.086	50
BICC	2003	COAX	*	-018	0.260	0.023	75
BLACKBOX	ETN59A	COAX	-2	-013	0.242	0.025	75
BOEING	380-10045	TRIAx	-60	-305	0.189	0.012	-
BOEING	443-50120-1	TRIAx	*	-	0.187	0.013	75
BOEING	5720-3280-002	TWINAX	-	-201	0.113	0.024	-
BOEING	D3-7619-9/1144	TRIAx	*	-	-	-	-
BOEING	S280W502	TWINAX	-64	-204	0.140	0.024	-
BOEING	STD0098-16-2SJ	TWINAX	*	TOO LARGE	0.188	0.054	-
BOSCH	SCC3902002-20B	TWINAX	-	-204	0.138	0.027	75
BRAND REX	H816	TWINAX	*	TOO LARGE	0.360	0.040	-

Note: \* = Special contact factory

## CABLE GROUP TABLE

CABLE MANUFACTURER	CABLE NUMBER	CABLE TYPE	WRENCH STYLE	CRIMP STYLE	JACKET SIZE	CONDUCTOR	IMPEDANCE
BRAND REX	T-12824	TRIAX	*	TOO LARGE	0.480	0.050	75
BRAND REX	T-13138	TRIAX	*	TOO LARGE	0.461	0.084	—
BRAND REX	T-13913	TWINAX	*	—	0.240	0.039	—
BRAND REX	T-14384	TWINAX	*	TOO LARGE	—	—	—
BRAND REX	T-14670	TWINAX	*	-215	0.237	0.030	—
BRAND REX	T-14922	TRIAX	*	—	0.230	0.029	—
BRAND REX	T-15075	TWINAX	*	TOO LARGE	0.370	0.040	—
BRAND REX	T18-11222-24-2/G-0	TWINAX	-27	-223	0.112	0.023	—
BRAND-REX	A-779	COAX	-5	-004	0.090	0.010	—
BRAND-REX	B-749	COAX	-44	105-1940 (220)	0.080	0.012	—
BRAND-REX	G719	TWINAX	*	—	0.225	0.031	—
BRAND-REX	LS2SWU-1(M24643/33-01UN)	TWINAX	*	—	0.255	0.050	75
BRAND-REX	M17/183-00001	COAX	-1	-011	0.195	0.035	50
BRAND-REX	T- 378	COAX	-6	-016	0.312	0.031	—
BRAND-REX	T-10970	TWINAX	—	—	0.154	0.025	77
BRAND-REX	T10971	TWINAX	*	—	0.155	0.025	—
BRAND-REX	T-10971	TWINAX	-24	-221	0.161	0.024	—
BRAND-REX	T-13294	TWINAX	*	TOO LARGE	0.285	0.040	—
BRAND-REX	T-13295	TRIAX	*	—	0.291	0.038	—
BRAND-REX	T-14018	TRIAX	-25A	—	0.250	0.030	—
BRAND-REX	T-2948	TRIAX	-26	—	0.165	0.012	—
BRAND-REX	T-385	COAX	-44	*	0.80	0.012	—
BRENDGEN	GX02273D	COAX	*	-027	0.130	0.09	75
BRITISH STANDARDS	BS 2316	TRIAX	-13A	TOO LARGE	0.335	0.024	72
BRITISH TELECOM	BT2001	COAX	*	*	0.181	0.024	75
BRITISH TELECOM	BT3002	COAX	*	*	0.145	0.012	75
BRITISH TELECOM	BT2003	COAX	*	-018	0.260	0.023	75
BRYANT BROADCAST	BDS01	COAX	-21	*	0.177	0.024	75
C&M WIRE AND CABLE	13637	COAX	-1	-021	0.199	0.036	50
C&M WIRE AND CABLE	P-14983	COAX	-5	-004	0.113	0.016	50
CALMONT	4141	TWINAX	-24	-211	0.168	0.012	—
CANARE	5C2VS	COAX	-6	-016	0.292	0.031	—
CANARE	L-3C2VS	COAX	-3	-019	0.217	0.021	75
CANARE	L-3CFB	COAX	-3	-022	0.217	0.026	75
CANARE	L-4CFB	COAX	-2	-014	0.240	0.032	75
CANARE	L-5CFB	COAX	-6	*	0.303	0.041	75
CANARE	L-7CFB	COAX	-6A	—	0.402	0.059	75
CANARE	LV-61S	COAX	-2	-013	0.240	0.024	75
CANARE	LV-77S	COAX	-6	-016	0.303	0.031	75
CANARE	V3-1.5C	COAX	-5	-004	0.102	0.011	75
CANARE	V3-3C	COAX	-21	*	0.173	0.021	75
CANARE	V3-3CFB	COAX	-21	*	0.173	0.026	75
CANARE	V3-4CFB	COAX	*	*	0.197	0.031	75

Note: \* = Special contact factory

# CABLE GROUP TABLE

CABLE MANUFACTURER	CABLE NUMBER	CABLE TYPE	WRENCH STYLE	CRIMP STYLE	JACKET SIZE	CONDUCTOR	IMPEDANCE
CANARE	V3-5C	COAX	-52	*	0.237	0.031	75
CANARE	V3-5CFB	COAX	—	-024	0.256	0.041	75
CANARE	V4-1.5C	COAX	-5	-004	0.102	0.011	75
CANARE	V4-3C	COAX	-21	*	0.173	0.021	75
CANARE	V4-3CFB	COAX	-21	*	0.173	0.026	75
CANARE	V4-4CFB	COAX	*	*	0.197	0.031	75
CANARE	V4-5C	COAX	-52	*	0.237	0.031	75
CANARE	V4-5CFB	COAX	—	-024	0.256	0.041	75
CANARE	V5-1.5C	COAX	-5	-004	0.102	0.011	75
CANARE	V5-3C	COAX	-21	*	0.173	0.021	75
CANARE	V5-3CFB	COAX	-21	*	0.173	0.026	75
CANARE	V5-4CFB	COAX	*	*	0.197	0.031	75
CANARE	V5-5C	COAX	-52	*	0.237	0.031	75
CANARE	V5-5CFB	COAX	—	-024	0.256	0.041	75
CANFORD	36-332 VCM RED	COAX	—	*	0.145	0.020	75
CANFORD	PSF 1/3	COAX	-2B	-015	0.250	0.024	75
CANFORD VIDEO	BBC PSF1/2M	COAX	—	-016	0.295	0.032	75
CANFORD VIDEO	BBC PSF1/3M	COAX	-2B	-015	0.252	0.024	75
CAROL	C5770	COAX	-2	-022	0.238	0.026	—
CAROL	C5779	COAX	*	-011	0.190	0.040	50
CAROL	C8000	TWINAX	-8	—	0.326	0.036	—
CASCO	2C227NPCSN	TWINAX	-45	—	—	—	—
CCI	2592A	COAX	-2	-013	0.242	0.025	73
CDT	CT100	COAX	-34	-024	0.253	0.039	75
CDT	CT100(RBS)	COAX	-6E	*	0.315	0.039	75
CHAMPLAIN	11-02789	TWINAX	*	-221	0.160	0.030	—
CHAMPLAIN	51-04496	TWINAX	-47	—	—	—	—
CHAMPLAIN	81-00440	TWINAX	-27	*	0.118	0.019	—
CHAMPLAIN	81-00544	120	*	—	0.136	0.021	TWINAX
CHAMPLAIN	NDBC-TFE-22-2SJ-75	TWINAX	-45	*	0.160	0.031	75
CHRYSLER TECHNOLOGIES	JW000043	TWINAX	—	*	0.168	0.025	77
CLARK	CV7559	COAX	-2	-014	0.242	0.032	75
CLARK WIRE	RG6-SD	COAX	-41	-020	0.275	0.041	75
CLARK WIRE & CABLE	CV752-PLEN	COAX	*	*	0.278	0.032	—
CLARK WIRE & CABLE	CV75SM	COAX	*	-009	0.157	0.018	—
CLARK WIRE & CABLE	TV559	TRIAx	*	—	0.360	0.030	75
CLARK WIRE & CABLE	TV7559	TRIAx	*	*	0.360	0.031	—
CLARK WIRE & CABLE	CV7559	COAX	—	-014	0.242	0.032	75
COAXCO	1102	TRIAx	*	—	0.145	0.019	—
COAXCO	1258	COAX	-44	*	0.084	0.013	—
COAXCO	0592-18	TRIAx	-23	*	0.138	0.021	—
COAXCO	33-1010-00-02	TRIAx	-23	*	0.144	0.024	75
COAXCO	33-1102-00-02	TRIAx	-23	—	0.142	0.021	—
COAXCO	33-1102-00-99	TRIAx	-23	*	0.144	0.021	—

Note: \* = Special contact factory

## CABLE GROUP TABLE

CABLE MANUFACTURER	CABLE NUMBER	CABLE TYPE	WRENCH STYLE	CRIMP STYLE	JACKET SIZE	CONDUCTOR	IMPEDANCE
COLEMAN	99901	COAX	_	-051	0.348	0.064	75
COLEMAN	821003	COAX	_	-051	0.348	0.064	75
COLEMAN	821005	COAX	_	-051	0.348	0.064	75
COLEMAN	921019	COAX	_	-020	0.268	0.040	75
COLEMAN	988423	COAX	-3	-012	0.212	0.035	50
COLEMAN CABLE	92005	COAX	-2	-013	0.242	0.025	75
COLEMAN/CCI	92004-XX-08	COAX	-2	-013	0.240	0.025	75
COLEMAN	99969	COAX	*	*	0.200	0.032	75
COMM/SCOPE	5905	COAX	-6A	-051	0.405	0.048	75
COMMSCOPE	85	COAX	_	_	0.362	0.0106	50
COMMSCOPE	216	COAX	_	_	0.362	0.0106	50
COMMSCOPE	222	COAX	-4	-009	0.155	0.024	75
COMMSCOPE	232	COAX	-4	-009	0.155	0.024	75
COMMSCOPE	242	COAX	-6A	_	0.415	0.064	75
COMMSCOPE	322	COAX	*	-009	0.160	0.020	_
COMMSCOPE	332	COAX	-4	-009	0.155	0.024	75
COMMSCOPE	355	COAX	_	_	0.382	0.064	75
COMMSCOPE	356	COAX	-6A	_	0.415	0.064	75
COMMSCOPE	357	COAX	_	-024	0.260	0.040	75
COMMSCOPE	358	COAX	-41	-020	0.280	0.040	75
COMMSCOPE	401	COAX	-22	-009	0.155	0.020	75
COMMSCOPE	2035	COAX	*	-026	0.127	0.016	75
COMMSCOPE	2446	TWINAX	*	TOO LARGE	0.435	0.051	_
COMMSCOPE	3104	COAX	-1	-011	0.188	0.037	50
COMMSCOPE	3130	COAX	-1	-021	0.201	0.032	50
COMMSCOPE	3135	COAX	-1	-021	0.199	0.035	50
COMMSCOPE	3136	COAX	-1	-011	0.199	0.037	50
COMMSCOPE	3139	COAX	-1	-021	0.202	0.031	50
COMMSCOPE	3140	COAX	-1	-021	0.195	0.033	50
COMMSCOPE	3141	COAX	-41	-020	0.272	0.040	75
COMMSCOPE	3222	COAX	*	TOO LARGE	0.412	0.106	50
COMMSCOPE	3226	COAX	*	TOO LARGE	0.412	0.106	50
COMMSCOPE	3227	COAX	*	_	0.412	0.106	50
COMMSCOPE	3228	COAX	*	_	0.412	0.106	50
COMMSCOPE	3229	COAX	*	_	0.412	0.106	50
COMMSCOPE	3246	COAX	-6B	_	0.418	0.086	50
COMMSCOPE	3247	COAX	-6B	_	0.418	0.086	50
COMMSCOPE	3249	COAX	-6B	_	0.413	0.086	50
COMMSCOPE	3250	COAX	-48	TOO LARGE	0.413	0.086	50
COMMSCOPE	5060	COAX	-6	*	0.308	0.040	75
COMMSCOPE	5061	COAX	-41	*	0.264	0.040	75
COMMSCOPE	5065	COAX	_	-009	0.160	0.020	92
COMMSCOPE	5535	COAX	*	-026	0.128	0.017	75
COMMSCOPE	5540	COAX	*	*	0.269	0.032	75

Note: \* = Special contact factory

# CABLE GROUP TABLE

CABLE MANUFACTURER	CABLE NUMBER	CABLE TYPE	WRENCH STYLE	CRIMP STYLE	JACKET SIZE	CONDUCTOR	IMPEDANCE
COMMSCOPE	5550	COAX	-2	-013	0.242	0.025	75
COMMSCOPE	5551	COAX	-2	-015	0.250	0.025	75
COMMSCOPE	5553	COAX	-2	-014	0.250	0.032	75
COMMSCOPE	5554	COAX	-2	-014	0.250	0.032	75
COMMSCOPE	5555	COAX	-2	-015	0.250	0.025	80
COMMSCOPE	5559	COAX	-2	-013	0.242	0.025	75
COMMSCOPE	5560	COAX	-2	-015	0.250	0.025	73
COMMSCOPE	5563	COAX	-2	-013	0.250	0.023	75
COMMSCOPE	5565	COAX	-2	-014	0.242	0.032	75
COMMSCOPE	5567	COAX	-2	-014	0.250	0.032	75
COMMSCOPE	5569	COAX	-2	-014	0.250	0.032	75
COMMSCOPE	5571	COAX	-2	-014	0.248	0.032	75
COMMSCOPE	5572	COAX	-2	-014	0.248	0.032	75
COMMSCOPE	5573	COAX	-2	-014	0.246	0.032	75
COMMSCOPE	5574	COAX	-2	-014	0.248	0.032	75
COMMSCOPE	5575	COAX	-2	-014	0.246	0.032	75
COMMSCOPE	5585	COAX	-2	-014	0.242	0.032	75
COMMSCOPE	5586	COAX	-2	-014	0.247	0.032	75
COMMSCOPE	5589	COAX	-2A	-022	0.235	0.025	75
COMMSCOPE	5700	COAX	-41	-020	0.280	0.040	75
COMMSCOPE	5701	COAX	-41	-020	0.280	0.040	75
COMMSCOPE	5702	COAX	-41	-020	0.280	0.040	75
COMMSCOPE	5713	COAX	*	*	0.290	0.040	75
COMMSCOPE	5714	COAX	-41	-020	0.280	0.040	75
COMMSCOPE	5715	COAX	-41	-020	0.280	0.040	75
COMMSCOPE	5720	COAX	-41	-020	0.280	0.040	75
COMMSCOPE	5721	COAX	-41	-020	0.272	0.040	75
COMMSCOPE	5723	COAX	-41	-020	0.272	0.040	75
COMMSCOPE	5725	COAX	-41	-020	0.276	0.040	75
COMMSCOPE	5727	COAX	-41	-020	0.280	0.040	75
COMMSCOPE	5728	COAX	-41	-020	0.280	0.040	75
COMMSCOPE	5729	COAX	-41	-020	0.280	0.040	75
COMMSCOPE	5730	COAX	-41	-020	0.280	0.040	75
COMMSCOPE	5731	COAX	-41	-020	0.272	0.040	75
COMMSCOPE	5737	COAX	-41	-020	0.280	0.040	75
COMMSCOPE	5738	COAX	-41	-020	0.272	0.040	75
COMMSCOPE	5740	COAX	-6	*	0.308	0.040	75
COMMSCOPE	5742	COAX	-6	*	0.308	0.040	75
COMMSCOPE	5750	COAX	-6	*	0.308	0.040	75
COMMSCOPE	5765	COAX	-41	-020	0.280	0.040	75
COMMSCOPE	5781	COAX	-6	*	0.306	0.040	75
COMMSCOPE	5782	COAX	-6	*	0.308	0.040	75
COMMSCOPE	5786	COAX	-41	-020	0.280	0.040	75
COMMSCOPE	5787	COAX	-41	-020	0.272	0.040	75

Note: \* = Special contact factory

## CABLE GROUP TABLE

CABLE MANUFACTURER	CABLE NUMBER	CABLE TYPE	WRENCH STYLE	CRIMP STYLE	JACKET SIZE	CONDUCTOR	IMPEDANCE
COMMSCOPE	5788	COAX	-41	-020	0.280	0.40	75
COMMSCOPE	5789	COAX	-41	-020	0.272	0.040	75
COMMSCOPE	5790	COAX	-41	-020	0.272	0.040	75
COMMSCOPE	5901	COAX	-6A	-053	0.405	0.064	75
COMMSCOPE	5902	COAX	-6A	_	0.415	0.064	75
COMMSCOPE	5903	COAX	-6A	-053	0.405	0.064	75
COMMSCOPE	5904	COAX	-6A	-053	0.405	0.064	75
COMMSCOPE	5906	COAX	-6A	-053	0.405	0.064	75
COMMSCOPE	5908	COAX	-6A	-051	0.405	0.048	75
COMMSCOPE	5909	COAX	-6A	-051	0.405	0.048	75
COMMSCOPE	5910	COAX	-6A	-052	0.395	0.064	75
COMMSCOPE	5912	COAX	-6A	-052	0.395	0.064	75
COMMSCOPE	5913	COAX	-6A	-053	0.405	0.064	75
COMMSCOPE	5914	COAX	-6A	-053	0.405	0.064	75
COMMSCOPE	5914	COAX	-6A	_	0.415	0.064	75
COMMSCOPE	5915	COAX	-6A	-053	0.405	0.064	75
COMMSCOPE	5916	COAX	-6A	-053	0.405	0.064	75
COMMSCOPE	5917	COAX	-6A	-053	0.405	0.064	75
COMMSCOPE	5918	COAX	-6A	_	0.412	0.064	75
COMMSCOPE	5920	COAX	-6A	-053	0.405	0.064	75
COMMSCOPE	5920	COAX	-6A	_	0.415	0.064	75
COMMSCOPE	5940	COAX	-6A	-053	0.405	0.064	75
COMMSCOPE	5950	COAX	-6A	-053	0.415	0.064	75
COMMSCOPE	5950	COAX	-6A	-053	0.405	0.064	75
COMMSCOPE	5951	COAX	-6A	_	0.405	0.064	75
COMMSCOPE	5952	COAX	-6A	_	0.415	0.064	75
COMMSCOPE	5953	COAX	-6A	_	0.415	0.064	75
COMMSCOPE	6200	COAX	-2	-015	0.242	0.025	92
COMMSCOPE	6201	COAX	-2	-013	0.242	0.025	93
COMMSCOPE	6205	COAX	*	-018	0.260	0.025	93
COMMSCOPE	6605	COAX	*	-018	0.267	0.025	93
COMMSCOPE	6608	COAX	-2	-015A	0.249	0.025	93
COMMSCOPE	6609	COAX	-2	-015A	0.249	0.025	93
COMMSCOPE	6611	COAX	-2	-015A	0.242	0.025	93
COMMSCOPE	6612	COAX	-2	-015A	0.242	0.025	93
COMMSCOPE	6615	COAX	-2	-015A	0.249	0.025	93
COMMSCOPE	7500	COAX	-6	-016	0.304	0.032	75
COMMSCOPE	7501	COAX	-6	-016	0.304	0.032	75
COMMSCOPE	7503	COAX	-6	-016	0.304	0.032	75
COMMSCOPE	7505	COAX	-6	-016	0.305	0.032	75
COMMSCOPE	7506	COAX	-6	-016	0.304	0.033	75
COMMSCOPE	7510	COAX	-6	-016	0.304	0.031	75
COMMSCOPE	7530	COAX	_	-054	0.318	0.051	75
COMMSCOPE	7536	COAX	-4	-009	0.150	0.023	75

Note: \* = Special contact factory



# CABLE GROUP TABLE

CABLE MANUFACTURER	CABLE NUMBER	CABLE TYPE	WRENCH STYLE	CRIMP STYLE	JACKET SIZE	CONDUCTOR	IMPEDANCE
COMMSCOPE	7537	COAX	-4	-009	0.154	0.023	75
COMMSCOPE	7538	COAX	-37	-009	0.159	0.022	75
COMMSCOPE	7551	COAX	-41	-020	0.272	0.040	75
COMMSCOPE	7573	COAX	-2A	-022	0.220	0.027	75
COMMSCOPE	7713	COAX	*	TOO LARGE	0.405	0.096	50
COMMSCOPE	7713	COAX	-6A	_	0.413	0.086	50
COMMSCOPE	7714	COAX	-6B	TOO LARGE	0.425	0.089	75
COMMSCOPE	7714	COAX	-6B	_	0.432	0.088	50
COMMSCOPE	7715	COAX	-6B	_	0.432	0.088	50
COMMSCOPE	7723	COAX	-3	-012	0.212	0.036	50
COMMSCOPE	7725	COAX	*	-023	0.220	0.036	50
COMMSCOPE	7726	COAX	-3	-012	0.220	0.036	50
COMMSCOPE	7810	TRIAX	*	TOO LARGE	0.325	0.032	75
COMMSCOPE	7811	TRIAX	_	_	0.360	0.032	75
COMMSCOPE	7815	TRIAX	_	_	0.480	_	50
COMMSCOPE	7820	TRIAX	_	_	0.475	0.064	75
COMMSCOPE	7825	TRIAX	_	_	0.520	0.071	75
COMMSCOPE	7826	TRIAX	*	TOO LARGE	0.519	0.068	_
COMMSCOPE	7901	TWINAX	*	TOO LARGE	0.334	0.038	100
COMMSCOPE	9012	TWINAX	-9	_	0.241	0.037	78
COMMSCOPE	57603	COAX	-41	-020	0.272	0.040	75
COMMSCOPE	57604	COAX	-41	-020	0.272	0.040	75
COMMSCOPE	57605	COAX	-41	-020	0.272	0.040	75
COMMSCOPE	72001	COAX	-22	-009	0.155	0.020	75
COMMSCOPE	72012	COAX	-22	-009	0.155	0.020	75
COMMSCOPE	72312	COAX	*	-026	0.127	0.016	75
COMMSCOPE	73501	COAX	*	-026	0.130	0.016	75
COMMSCOPE	73502	COAX	*	-026	0.130	0.016	75
COMMSCOPE	73503	COAX	*	-026	0.130	0.016	75
COMMSCOPE	73506	COAX	*	-026	0.127	0.016	75
COMMSCOPE	73508	COAX	*	-026	0.127	0.016	75
COMMSCOPE	73509	COAX	*	-026	0.127	0.016	75
COMMSCOPE	73512	COAX	*	-026	0.126	0.015	75
COMMSCOPE	75603	COAX	_	-009	0.150	0.022	75
COMMSCOPE	75604	COAX	_	-009	0.150	0.022	75
COMMSCOPE	556510	COAX	-2	-014	0.242	0.032	75
COMMSCOPE	576503	COAX	-41	-020	0.272	0.040	75
COMMSCOPE	576504	COAX	-41	-020	0.272	0.040	75
COMMSCOPE	576505	COAX	-41	-020	0.272	0.040	75
COMMSCOPE	753603	COAX	-4	-009	0.150	0.022	75
COMMSCOPE	753604	COAX	-4	-009	0.150	0.022	75
COMMSCOPE	753605	COAX	-4	-009	0.150	0.022	75
COMMSCOPE	0132K	COAX	*	-024	0.242	0.040	75
COMMSCOPE	0132V	COAX	*	-024	0.242	0.040	75

Note: \* = Special contact factory

## CABLE GROUP TABLE

CABLE MANUFACTURER	CABLE NUMBER	CABLE TYPE	WRENCH STYLE	CRIMP STYLE	JACKET SIZE	CONDUCTOR	IMPEDANCE
COMMSCOPE	0219K	COAX	-1	-012	0.200	0.036	50
COMMSCOPE	0243K	COAX	_	_	0.277	0.064	75
COMMSCOPE	0247K	COAX	-41	-020	0.268	0.040	75
COMMSCOPE	0247V	COAX	-41	-020	0.268	0.040	75
COMMSCOPE	0359K	COAX	*	-024	0.241	0.041	75
COMMSCOPE	0359K	COAX	*	-024	0.241	0.041	75
COMMSCOPE	2020K	COAX	*	*	0.209	0.032	75
COMMSCOPE	2020V	COAX	*	*	0.209	0.032	75
COMMSCOPE	2022K	COAX	-2	-023	0.239	0.032	75
COMMSCOPE	2022V	COAX	-2	-23	0.239	0.032	75
COMMSCOPE	2037V	COAX	*	*	0.199	0.032	75
COMMSCOPE	2039K	COAX	*	*	0.199	0.032	75
COMMSCOPE	2039V	COAX	*	*	0.199	0.032	75
COMMSCOPE	2040K	COAX	*	*	0.197	0.025	75
COMMSCOPE	2040V	COAX	*	*	0.197	0.025	75
COMMSCOPE	2041K	COAX	*	*	0.205	0.023	75
COMMSCOPE	2045K	COAX	*	*	0.209	0.032	75
COMMSCOPE	2045V	COAX	*	*	0.209	0.032	75
COMMSCOPE	2054K	COAX	_	*	0.161	0.032	75
COMMSCOPE	2065V	COAX	*	*	0.199	0.032	75
COMMSCOPE	2068K	COAX	-63	-025	0.219	0.032	_
COMMSCOPE	2096K	COAX	*	*	0.205	0.032	75
COMMSCOPE	2100K	COAX	-21	*	0.169	0.032	50
COMMSCOPE	2100V	COAX	-21	*	0.169	0.032	53
COMMSCOPE	2104K	COAX	*	*	0.166	0.037	50
COMMSCOPE	2104V	COAX	*	*	0.166	0.037	50
COMMSCOPE	2125K	COAX	-1	-012	0.200	0.036	50
COMMSCOPE	2227K	COAX	-41	-020	0.264	0.040	75
COMMSCOPE	2227V	COAX	-41	*	0.264	0.040	75
COMMSCOPE	2229V	COAX	-41	-020	0.268	0.040	75
COMMSCOPE	2249K	COAX	*	*	0.204	0.025	93
COMMSCOPE	2249V	COAX	*	*	0.206	0.025	93
COMMSCOPE	2250K	COAX	*	*	0.214	0.025	93
COMMSCOPE	2250V	COAX	*	*	0.214	0.025	93
COMMSCOPE	2251K	COAX	*	*	0.207	0.025	93
COMMSCOPE	2274V	COAX	*	-024	0.241	0.040	75
COMMSCOPE	2275K	COAX	*	-024	0.241	0.040	75
COMMSCOPE	2275V	COAX	*	-024	0.241	0.040	75
COMMSCOPE	2276V	COAX	*	-024	0.241	0.040	75
COMMSCOPE	2277K	COAX	*	*	0.233	0.040	75
COMMSCOPE	2277V	COAX	*	*	0.233	0.040	75
COMMSCOPE	2278K	COAX	*	-024	0.242	0.040	75
COMMSCOPE	2279K	COAX	*	*	0.237	0.040	75
COMMSCOPE	2279V	COAX	*	*	0.237	0.040	75

Note: \* = Special contact factory

# CABLE GROUP TABLE

CABLE MANUFACTURER	CABLE NUMBER	CABLE TYPE	WRENCH STYLE	CRIMP STYLE	JACKET SIZE	CONDUCTOR	IMPEDANCE
COMMSCOPE	2281K	COAX	*	TOO LARGE	0.347	0.089	50
COMMSCOPE	2282K	COAX	—	—	0.359	0.064	75
COMMSCOPE	2285K	COAX	*	TOO LARGE	0.359	0.064	75
COMMSCOPE	2286K	COAX	—	—	0.353	0.064	75
COMMSCOPE	2287K	COAX	*	TOO LARGE	0.380	0.064	75
COMMSCOPE	2288K	COAX	—	—	0.378	0.064	75
COMMSCOPE	2291K	TWINAX	-25	—	0.260	0.039	100
COMMSCOPE	2312K	COAX	—	—	0.534	0.109	75
COMMSCOPE	2426K	COAX	—	—	0.355	0.106	50
COMMSCOPE	2427K	COAX	—	—	0.362	0.106	50
COMMSCOPE	2525K	COAX	*	-016	0.290	0.031	75
COMMSCOPE	2527K	COAX	-41	*	0.279	0.032	75
COMMSCOPE	4022(K)	TWINAX	*	—	0.219	0.038	78
COMMSCOPE	425-0256	COAX	—	-025	0.240	0.033	75
COMMSCOPE	5060F	COAX	-6	*	0.308	0.040	75
COMMSCOPE	5060R	COAX	-6	*	0.308	0.040	75
COMMSCOPE	5550M	COAX	-2	-013A	0.242	0.030	75
COMMSCOPE	5568M	COAX	*	-025	0.240	0.033	—
COMMSCOPE	5726R	COAX	-41	-020	0.276	0.041	75
COMMSCOPE	5740F	COAX	-6	*	0.308	0.038	75
COMMSCOPE	5740H1	COAX	-6	*	0.308	0.040	75
COMMSCOPE	5740R	COAX	-6	*	0.308	0.040	75
COMMSCOPE	5913R	COAX	-6A	—	0.415	0.064	75
COMMSCOPE	5916R	COAX	-6A	TOO LARGE	0.415	0.064	75
COMMSCOPE	720T1	COAX	-22	-009	0.155	0.020	75
COMMSCOPE	720T2	COAX	-22	-009	0.155	0.020	75
COMMSCOPE	734C()	COAX	-63	-025	0.236	0.032	75
COMMSCOPE	734C1H	COAX	-63	-025	0.236	0.032	75
COMMSCOPE	734C1P	COAX	-63	*	0.219	0.032	75
COMMSCOPE	734S()	COAX	-63	-025	0.236	0.032	75
COMMSCOPE	734S1H	COAX	-63	-025	0.236	0.032	75
COMMSCOPE	734ST	COAX	-63	-025	0.236	0.032	75
COMMSCOPE	734STH	COAX	-63	-025	0.236	0.032	75
COMMSCOPE	735(#)	COAX	*	-026	0.130	0.016	75
COMMSCOPE	735()H	COAX	*	-026	0.129	0.016	75
COMMSCOPE	735()P	COAX	*	-026	0.127	0.016	75
COMMSCOPE	73501B	COAX	—	-026	0.137	0.016	75
COMMSCOPE	73501H	COAX	*	-026	0.127	0.016	75
COMMSCOPE	73501S	COAX	—	*	0.137	0.016	75
COMMSCOPE	73502H	COAX	*	-026	0.127	0.016	75
COMMSCOPE	735T()H	COAX	*	-026	0.129	0.016	75
COMMSCOPE	735T2	COAX	*	-026	0.126	0.016	75
COMMSCOPE	F1160BV	COAX	-6A	*	0.395	0.064	75
COMMSCOPE	F1160BVV	COAX	-6A	*	0.395	0.064	75

Note: \* = Special contact factory

## CABLE GROUP TABLE

CABLE MANUFACTURER	CABLE NUMBER	CABLE TYPE	WRENCH STYLE	CRIMP STYLE	JACKET SIZE	CONDUCTOR	IMPEDANCE
COMMSCOPE	F11SSEF	COAX	-6A	_	0.405	0.064	75
COMMSCOPE	F11SSVV	COAX	-6A	TOO LARGE	0.395	0.064	_
COMMSCOPE	F59 HEC T/CU	COAX	*	*	0.270	0.032	75
COMMSCOPE	F59 HEC/3-22	COAX	*	*	0.265	0.032	75
COMMSCOPE	F59 HEC-2	COAX	*	*	0.265	0.032	75
COMMSCOPE	F5967BVM	COAX	-2	-014	0.240	0.032	75
COMMSCOPE	F5967BVV	COAX	-2	-014	0.240	0.032	75
COMMSCOPE	F59SSEF	COAX	*	*	0.265	0.032	75
COMMSCOPE	F59SSV	COAX	*	*	0.272	0.033	75
COMMSCOPE	F660BVV	COAX	-41	-020	0.272	0.040	75
COMMSCOPE	F6SSEF	COAX	-6	*	0.300	0.040	75
COMMSCOPE	F6SSVM-APDI-22-APD	COAX	_	-020	0.281	0.040	75
COMMSCOPE	F6SSVR	COAX	*	*	0.300	0.040	75
COMMSCOPE	F6SSVV	COAX	*	*	0.300	0.040	75
COMMSCOPE	F6SSVX	COAX	*	*	0.298	0.040	75
COMMSCOPE	HEC/3-22	COAX	*	*	0.265	0.032	75
COMMSCOPE	HEC-2	COAX	*	*	0.265	0.032	75
COMMSCOPE	OP73801DB	COAX	-6	*	0.290	0.040	75
COMMSCOPE	S59 HEC	COAX	*	*	0.269	0.023	75
COMMSCOPE	VDM230	COAX	_	-009	0.171	0.023	75
COMMSCOPE	WBC-240(R)	COAX	*	*	0.240	0.056	50
COMMSCOPE	WBC-300(R)	COAX	-6	*	0.070	0.070	50
COMMSCOPE NETWORK CABLE	73608 8/30 AWG	COAX	*	*	0.112	0.012	75
COMMSCOPE	5726	COAX	-41	-020	0.272	0.040	74
COMPOSITE VIDEO	VA-2/2	COAX	_	-009	_	_	75
COMPREHENSIVE VIDEO	CVC-59STXF	COAX	-2	-023	0.236	0.031	75
CONDUMEX	77827876	COAX	*	*	0.183	0.021	_
CONDUMEX	801289	COAX	_	*	0.304	0.040	75
CONSOLIDATED	4459	COAX	-5	-003	0.105	0.019	50
CONSOLIDATED	4462	TRIAx	*	_	0.485	0.091	50
CONTEL	1429425182	TWINAX	*	_	0.194	0.025	_
COONER WIRE	AS 450-3075SR	COAX	-36	_	0.097	0.012	75
COONER WIRE	AS450-3000SR	COAX	-44	*	0.070	0.012	_
COONER WIRE	AS471	COAX	-5A	_	0.065	0.012	_
COONER WIRE	CW2040-2675 SR	COAX	_	-026	0.136	0.019	75
CPI	33-1102-00-02	TRIAx	_	*	0.145	0.023	40
CUSHCRAFT	90262	COAX	-1	-011	0.195	0.039	50
DABURN	D-43M	TWINAX	-25	_	0.265	0.019	_
DEARBORN	2498	TWINAX	-8	TOO LARGE	0.333	0.037	100
DEC	FEP 17-01246-01/02/03	COAX	-3	-011	_	_	_
DEC	FEP17-0246-01/02	COAX	-3	-011	_	_	_
DEC	FEP17-0248-01/02	COAX	-3	-011	_	_	_
DELCO	1354	COAX	-51	-016	0.303	0.033	75
DELCO	91783	COAX	-21	-021	0.194	0.036	50

Note: \* = Special contact factory

# CABLE GROUP TABLE

CABLE MANUFACTURER	CABLE NUMBER	CABLE TYPE	WRENCH STYLE	CRIMP STYLE	JACKET SIZE	CONDUCTOR	IMPEDANCE
DELCO	389636	COAX	*	-016	0.309	0.031	75
DELCO	396121	coax	_	-009	0.161	0.024	75
DELCO	396121	COAX	-4	-009	0.161	0.019	75
DELCO	396191	COAX	_	-009	0.161	0.024	75
DOD	DOD-DNA-RF-21	TWINAX	*	_	0.260	0.022	_
DRAKA	0.6/3.7	COAX	_	-022	0.237	0.024	75
DRAKA	IMAGE720	COAX	_	-019	0.232	0.031	75
DRAKA USA	7341101	CAOX	*	*	0.298	0.040	75
DRAKA USA	7341102	COAX	*	*	0.298	0.040	75
DRAKA-HELEX	32448A	COAX	_	-030	_	_	75
DRAKE	IMAGE1000	COAX	_	-020	0.268	0.039	75
DYTRAN	6425A03	COAX	-1	-011	0.193	0.037	50
ECS	322001	TRIAx	_	-306	0.240	0.037	50
ECS	322401	TRIAx	_	*	0.255	0.025	75
ECS	352001	COAX	-21	*	0.162	0.042	50
ECS	392402	TWINAX	-24	*	0.162	0.024	100
ECS	632101	TRIAx	-43	_	0.169	0.034	_
ECS	3C178TX-C	TRIAx	*	_	0.125	0.013	50
ELECTRONIC CABLE	412301-75	COAX	_	-009	0.150	0.023	75
EMTEQ	D12502-200	TWINAX	-33	-224	0.205	0.026	_
EMTEQ	PFLX200-100	COAX	-3	-012	0.205	0.039	50
EMTEQ	TFLX130-100	COAX	_	_	0.130	0.030	50
ENDEVCO	3090C	COAX	-5B	-001	0.090	0.012	50
ENDEVCO	PS6960	TWINAX	*	_	0.190	0.037	_
ERICSSON	1301-TZC 751 08	TRIAx	*	-305	0.177	0.012	_
ERICSSON	1301-TZE 101 09	COAX	_	*	0.140	0.013	75
ERICSSON	TZC 750 24	COAX	-22	*	0.143	0.012	75
ERICSSON	TZC 751 08	TRIAx	*	-305	0.179	0.012	_
ESA/SCC	3902/002 VARIANT 20	TWINAX	_	-204	0.149	0.026	75
ESA/SCC	3902/002-06	COAX	*	-006	0.114	0.019	75
ESSEX	1000	COAX	-6A	_	0.405	0.085	_
ESSEX	21-004	COAX	-6A	_	0.405	0.085	_
ESSEX	21-025	COAX	-2	_	0.242	0.025	_
ESSEX	21-204	TRIAx	-42	_	0.285	0.036	_
ESSEX	21-529	TRIAx	-14	_	0.460	0.049	_
ESSEX	21-537	COAX	-1	-011	0.195	0.036	_
ESSEX	21-541	COAX	-2	-013	0.242	0.025	_
ESSEX	21-583	TRIAx	-15	TOO LARGE	0.490	0.085	53
ESSEX	21-597	COAX	-22	-009	0.150	0.017	_
ESSEX	21-780	COAX	-6B	_	0.420	0.087	_
ESSEX	21-795	COAX	-2	_	0.242	0.023	_
ESSEX	421-098	COAX	-22	-008	0.145	0.012	_
ESSEX	421-111	COAX	-22	-008	0.155	0.012	_
ESSEX	421-176	COAX	-1	_	0.195	0.039	_

Note: \* = Special contact factory

## CABLE GROUP TABLE

CABLE MANUFACTURER	CABLE NUMBER	CABLE TYPE	WRENCH STYLE	CRIMP STYLE	JACKET SIZE	CONDUCTOR	IMPEDANCE
ESSEX	621-100	COAX	-6A	_	0.405	0.064	_
ESSEX	621-106	TRIAx	-7	_	0.242	0.025	_
ESSEX	621-243	COAX	-41	_	0.270	0.040	_
ESSEX	621-284	COAX	-41	_	0.270	0.040	_
ESSEX	621-715	COAX	-1	*	0.195	0.025	_
EUROCABLE	LKRX75S2D4	COAX	-22	-009	0.157	0.020	75
EXTRON	22-021-01	COAX	-5	-003	_	_	_
EXTRON	22-032-02/-03	COAX	*	*	0.107	0.016	75
EZ FORM CABLE CORP	EZ FLEX 402	COAX	-21	*	0.163	0.036	50
FARINON	003-R003	COAX	-37	-009	0.162	0.020	75
FILECA	F2703-51	TWINAX	_	-217	_	_	_
FILECA	F27-09/9	TWINAX	*	_	0.176	0.031	_
FILOTEX	11820	TRIAx	*	_	0.283	0.037	50
FILOTEX	63247	TWINAX	_	-212	0.179	0.025	_
FILOTEX	96770	TWINAX	-47	_	0.142	0.024	_
FILOTEX	374693	COAX	-22	-009	0.149	0.020	_
FILOTEX	ET39110ED2	TRIAx	-15	TOO LARGE	0.490	0.064	_
FILOTEX	L910/39	COAX	-22	-009	0.155	0.020	_
FILOTEX	L910-42	COAX	-22	-009	0.155	0.020	_
FILOTEX	SP 68150	TWINAX	_	*	0.180	0.027	125
FILOTEX	SP714	TRIAx	-23	_	0.138	0.012	75
FLEXTRONICS	2001	COAX	-22	*	0.143	0.013	75
FLEXTRONICS	2003	COAX	*	-018	0.270	0.024	75
FOKKER SPACE	DK75-2-22	COAX	*	-026	0.130	0.017	75
FOKKER SPACE	KBCO-75	TWINAX	-29	-217	0.149	0.024	_
FUJIKURA	1990	COAX	-5B	*	0.102	0.012	50
FUJIKURA	3C-2V	COAX	*	-019	0.225	0.020	75
FUJIKURA	3C-2W	COAX	_	_	0.261	0.020	_
FUJIKURA	5C-2V	COAX	-6	-016	0.301	0.031	_
FURUNO	RW-6895-0	COAX	-22	*	0.143	0.014	75
GENERAL	C1156	COAX	-5	-003	0.100	0.019	50
GENERAL	T-43	TWINAX	-10	_	0.420	0.040	_
GENERAL	T-43M	TWINAX	-25	_	0.265	0.019	_
GENERAL	V1-AL	TWINAX	-12	_	0.460	0.051	_
GENERAL	V1-DSAL	QUADRAX	28	_	0.530	0.050	_
GENERAL CABLE	1891Q-222-32	COAX	*	*	0.194	0.032	_
GENERAL CABLE	C3500	COAX	*	*	0.200	0.023	75
GENERAL CABLE	C3519	COAX	-21	*	0.161	0.036	50
GENERAL CABLE	C3521	COAX	*	*	0.235	0.040	75
GENERAL CABLE	C5844	COAX	_	-014	0.242	0.032	75
GENERAL CABLE	E86009	COAX	*	*	0.200	0.032	75
GENERAL CABLE	LL79301	COAX	*	*	0.200	0.032	75
GENERAL DYNAMICS	C10989-1	TWINAX	_	_	_	_	120
GENERAL DYNAMICS	C8898	TRIAx	-24A	-309	0.153	0.013	95

Note: \* = Special contact factory

# CABLE GROUP TABLE

CABLE MANUFACTURER	CABLE NUMBER	CABLE TYPE	WRENCH STYLE	CRIMP STYLE	JACKET SIZE	CONDUCTOR	IMPEDANCE
GENERAL WIRE	82K03878/9A	COAX	-21	-011	0.173	0.038	50
GENERAL WIRE	C5025	COAX	-6A	-053	0.405	0.064	75
GENERAL WIRE PRODUCTS	001-16416	TWINAX	-12	TOO LARGE	0.444	0.035	_
GENERAL WIRE PRODUCTS	001-21287	TWINAX	*	TOO LARGE	0.256	0.024	_
GENERAL CABLE	4162A	TWINAX	*	_	0.210	0.025	_
GEPCO	7174	COAX	-5	-003	0.101	0.019	50
GEPCO	7537	COAX	-4	-009	0.160	0.023	75
GEPCO	7538	COAX	-37	-009	0.159	0.023	75
GEPCO	7826	TRIAX	*	TOO LARGE	0.512	0.068	_
GEPCO	7913	COAX	_	_	0.405	0.064	75
GEPCO	7915	COAX	_	_	0.405	0.064	75
GEPCO	2279K	COAX	*	*	0.237	0.040	75
GEPCO	2279V	COAX	*	*	0.237	0.040	75
GEPCO	2297V	COAX	*	*	0.237	0.040	75
GEPCO	LVT61811	TRIAX	-15	TOO LARGE	0.516	0.068	75
GEPCO	LVT61859	TRIAX	*	TOO LARGE	0.357	0.031	75
GEPCO	RGB6000	COAX	-6	-016	0.304	0.032	75
GEPCO	RGB809	COAX	-22	-009	0.150	0.021	75
GEPCO	RGBS809	COAX	-22	-009	0.150	0.021	75
GEPCO	RGBSC809	COAX	-22	-009	0.150	0.021	75
GEPCO	V61859M	COAX	-2	_	0.242	0.030	75
GEPCO	V618J59	COAX	-2	-013	0.242	0.023	75
GEPCO	V618M59	COAX	-2	-013	0.242	0.023	75
GEPCO	V618M59TK	COAX	*	*	0.200	0.023	75
GEPCO	VDFM809	COAX	-22	-009	0.150	0.021	75
GEPCO	VE61859	COAX	-2	-013A	0.242	0.030	75
GEPCO	VE61859M	COAX	-2	-013A	0.242	0.030	75
GEPCO	VFM809	COAX	-22	-009	0.150	0.022	75
GEPCO	VP6000	COAX	-6	-016	0.304	0.032	75
GEPCO	VP618PE/AP	COAX	-6	-016	0.304	0.032	75
GEPCO	VP618PE01	COAX	-6	-016	0.304	0.031	75
GEPCO	VP618PVC	COAX	-6	-016	0.304	0.032	75
GEPCO	VP618TK	COAX	-41	*	0.276	0.032	75
GEPCO	VPM1000	COAX	-2	-013	0.242	0.023	75
GEPCO	VPM2000	COAX	-2	-014	0.242	0.032	75
GEPCO	VPM2000TK	COAX	*	*	0.200	0.032	75
GEPCO	VPM2000TS	COAX	*	*	0.199	0.032	75
GEPCO	VPM618	COAX	-2A	-022	0.220	0.027	75
GEPCO	VS102000	COAX	-2	-014	0.243	0.032	75
GEPCO	VSD20001TS	COAX	_	_	0.237	0.045	75
GEPCO	VSD2001	COAX	-41	-020	0.273	0.040	75
GEPCO	VSM618	COAX	-22	-009	0.150	0.017	75
GEPCO	VT61811	TRIAX	-14	TOO LARGE	0.474	0.065	75
GEPCO	VT61859	TRIAX	*	TOO LARGE	0.360	0.034	75

Note: \* = Special contact factory



## CABLE GROUP TABLE

CABLE MANUFACTURER	CABLE NUMBER	CABLE TYPE	WRENCH STYLE	CRIMP STYLE	JACKET SIZE	CONDUCTOR	IMPEDANCE
GORE	03352/CX	TRIAX	_	-303	0.150	0.012	_
GORE	C06C032	COAX	-5A	-001	0.075	0.019	_
GORE	CXA-8220	TRIAX	-60	-305	0.187	0.025	_
GORE	CXN-1267C	COAX	*	_	0.135	0.024	75
GORE	CXN-1352B	COAX	-44	*	0.078	0.016	_
GORE	CXN-1362	COAX	-36	_	0.101	0.031	_
GORE	CXN-1384	COAX	*	_	_	_	_
GORE	CXN-1388	COAX	-5	-003	0.110	0.020	_
GORE	CXN-1417A	COAX	*	*	0.107	0.020	_
GORE	CXN-1456	COAX	-44	_	0.74	0.019	_
GORE	CXN-1722	COAX	-86	*	0.086	0.012	_
GORE	CXN-1839	COAX	*	TOO LARGE	0.280	0.088	_
GORE	CXN-1939	COAX	-44	*	0.78	0.010	93
GORE	CXN-2223	TWINAX	-24	_	0.141	0.025	_
GORE	CXN-2268	TWINAX	_	-204	0.135	0.025	_
GORE	CXN-2363	TWINAX	_	-221	0.166	0.025	_
GORE	CXN-2702	TWINAX	_	-221	0.166	0.025	100
GORE	CXN-3101	COAX	-5	-004	0.93	0.012	75
GORE	CXN-3162	TWINAX	*	-223	0.112	0.021	100
GORE	CXN-3194	TWINAX	_	-204	0.138	0.024	80
GORE	CXN3268	TRIAX	-27 (150)	_	0.100	0.012	50
GORE	CXP 3716	COAX	*	_	_	_	_
GORE	DXN1830	TWINAX	_	*	0.130	0.019	_
GORE	DXSN1482	TWINAX	*	_	0.103	0.018	_
GORE	DXSN-1735	COAX	*	*	0.081	0.018	_
GORE	DXSN-1747	COAX	-44	-001	0.080	0.011	_
GORE	DXSN-1878	TWINAX	*	_	0.113	0.019	_
GORE	DXSN-1888	TWINAX	_	-203	0.148	0.015	150
GORE	DXSN1892	COAX	-36	*	0.103	0.018	_
GORE	DXSN-1896	COAX	_	*	0.082	0.014	_
GORE	GBL-075-024	TWINAX	-29	-204	0.132	0.025	_
GORE	GCX-075-26-REV A	COAX	-36	*	0.099	0.019	_
GORE	GSC 03-2236-00	COAX	_	-004	0.092	0.012	75
GORE	GSC-01-40583-01	COAX	_	*	0.63	0.010	75
GORE	GSC-01-81457-00	TWINAX	-27	-209	0.118	0.016	120
GORE	GSC-03-1276-00	TRIAX	*	_	0.103	0.020	50
GORE	GSC-03-40389-00	COAX	*	_	0.62	0.010	75
GORE	GSC-05-80583-00	TWINAX	_	-202	0.145	0.021	_
GORE	GSC-12-1381-01	TWINAX	-45	_	0.160	0.024	_
GORE	GSC-12-1381-01-93	TWINAX	*	_	0.143	0.023	_
GORE	GWN2388	TWINAX	*	_	0.095	0.015	_
GREAT LAKES	70014	COAX	_	*	0.107	0.019	75
GREENWOOD	RA523PVC	COAX	*	_	0.320	0.075	_
GRUMMAN	GC875ACH1	TWINAX	*	-224	0.190	0.024	98

Note: \* = Special contact factory

# CABLE GROUP TABLE

CABLE MANUFACTURER	CABLE NUMBER	CABLE TYPE	WRENCH STYLE	CRIMP STYLE	JACKET SIZE	CONDUCTOR	IMPEDANCE
GRUMMAN	GC875GBI	TRIAX	-57	-302	0.164	0.033	_
GRUMMAN	GC875GC1	TRIAX	-56	-301	0.164	0.012	_
GRUMMAN	GC875GP1	COAX	-31	-006	0.128	0.020	_
GRUMMAN	GC875LNI	TWINAX	59	_	0.167	0.020	_
GRUMMAN	GC875PD1	COAX	-5A	_	0.063	0.012	_
GRUMMAN	GC875RM1	TWINAX	-45	-204	0.144	0.025	_
GRUMMAN	GC875RR1	QUADRAX	-33	-220	0.179	0.025	_
GRUMMAN	GC875TM24H	TRIAX	-58	-221	0.160	0.025	_
GRUMMAN	GC875TMH	TWINAX	-45	-204	0.146	0.025	_
H.P.	TXA114-P	TRIAX	*	*	0.217	0.021	_
HABIA	1652	TRIAX	*	_	0.115	0.012	50
HABIA	1852	TRIAX	*	_	0.110	0.012	50
HABIA	4570	TRIAX	-23	-303	0.145	0.012	75
HABIA	4570	TRIAX	-23	-303	0.142	0.012	75
HABIA	103-06208-010	TWINAX	_	-204	0.141	0.024	78
HABIA	31482-009-02	TWINAX	-47	-201	0.134	0.024	77
HABIA	31789-003-01	COAX	-21	-021	0.176	0.032	_
HABIA	HPD 6UK4577TK-03	TWINAX	*	*	0.169	0.024	83
HABIA	HPD 6UK4674LT-01	TRIAX	*	-303	0.138	0.012	50
HABIA	RG 223	TRIAX	-7	-306	0.248	0.035	50
HABIA	RGS-T-302(HFJ)	TRIAX	*	TOO LARGE	0.335	0.025	_
HABIA	RGT 178	TRIAX	-23	-303	0.142	0.012	50
HABIA	RGT 180	TRIAX	-60	-305	0.197	0.012	95
HABIA	RGT 316	TRIAX	-23	_	0.142	0.021	50
HABIA	RGX180	TRIAX	-60	_	0.186	0.012	_
HABIA	Y-HRGT-213	TRIAX	*	TOO LARGE	0.531	0.088	50
HABIA	Y-HRGT-58	TRIAX	*	_	0.291	0.035	50
HABIA	Y-HRGT-59	TRIAX	-13	_	0.335	0.024	75
HAN WEI	1928 001A	COAX	_	-026	0.132	0.018	75
HAN WEI	1928-008A	COAX	*	-026	0.139	0.016	75
HAN WEI	735A	COAX	_	-026	0.139	0.018	75
HAN WEI	RG 179	COAX	_	-004	0.102	0.012	75
HAN WEI	RG 213	COAX	-6B	TOO LARGE	0.417	0.087	50
HAN WEI	RG 59	COAX	-2	-013	0.242	0.024	75
HAN WEI	RG 62A	COAX	-2B	-013B	0.242	0.026	93
HARBOUR	12-557	TRIAX	-64	-303	0.147	0.012	75
HARBOUR	H7000	COAX	*	_	0.200	0.052	50
HARBOUR	HPF195	COAX	_	-011	0.195	0.037	75
HARBOUR	IEEE 802.3	COAX	-21	*	0.167	0.038	_
HARBOUR	LL142	COAX	*	_	0.195	0.051	50
HARBOUR	SB142	COAX	-1	-021	0.195	0.037	50
HARBOUR	SS405	COAX	-5	-003	0.104	0.020	50
HARBOUR	TRX179	TRIAX	-23	_	0.141	0.012	_
HARBOUR	TRX180	TRIAX	-60	-305	0.180	0.012	95

Note: \* = Special contact factory

## CABLE GROUP TABLE

CABLE MANUFACTURER	CABLE NUMBER	CABLE TYPE	WRENCH STYLE	CRIMP STYLE	JACKET SIZE	CONDUCTOR	IMPEDANCE
HARBOUR	TRX400	TRIAX	*	-306	0.215	0.039	—
HARBOUR IND	ST5M1212-002	TWINAX	-47	-201	0.124	0.023	68
HARRIS	2000566	TWINAX	—	-205	0.095	0.015	—
HAVEG INDUSTRIES	51-04416	TWINAX	—	-223	0.104	0.019	—
HEADEND	2240V	COAX	*	*	0.269	0.032	—
HELIX	CF18C0011030	COAX	*	*	0.231	0.040	—
HELIX	CF30P001XXXX	TWINAX	*	—	0.139	0.013	124
HELIX/HITEMP	8340101	COAX	—	*	0.223	0.032	75
HELIX/Hi-TEMP	735201	COAX	—	-026	0.135	0.016	75
HELIX/Hi-TEMP	7340101	COAX	—	-025	0.241	0.032	75
HEWLETT PACKARD	03053-61672	TRIAX	*	—	0.200	0.021	—
HEWLETT PACKARD	8120-0049	COAX	-4	-008	0.155	0.010	—
HEWLETT PACKARD	8120-0552-1	COAX	-5B	*	0.110	0.015	50
HEWLETT PACKARD	8120-0789	COAX	-5B	—	0.110	0.015	—
HEWLETT PACKARD	8120-1105	COAX	-5B	-002	0.110	0.015	—
HEWLETT PACKARD	8120-1289	COAX	-2B	-015	0.255	0.025	—
HEWLETT PACKARD	8120-4461	COAX	-5	-003	0.093	0.018	50
HEWLETT PACKARD	8120-9026	COAX	-5B	—	0.110	0.015	—
HEWLETT PACKARD	A-8120-9077-1	COAX	-5	*	0.110	0.015	—
HITACHI	HCM-39441/1	COAX	*	-027	0.128	0.016	75
HITACHI	HCM-9441/12	COAX	*	-026	0.133	0.016	75
HITEMP	117P80660	COAX	-50	—	0.375	0.086	—
HITEMP	RD1152	COAX	*	-026	0.132	0.016	75
HITEMP	RD1152-1	COAX	*	*	0.159	0.016	75
HITEMP	RD1152-2	COAX	-22	*	0.143	0.016	75
HITEMP	SP50-738CWSSTJ	COAX	*	—	0.085	0.012	—
HOMESTAR	1501	COAX	—	—	0.288	0.040	75
HONEYWELL	P7500577	TRIAX	-25A	-306	0.250	0.038	50
HUBER-SUHNER	G04233D	COAX	—	-013	0.240	0.024	75
HUGHES	710855-35	TRIAX	*	—	0.460	0.047	—
HUGHES	720304-1	COAX	-5	*	0.080	0.012	—
HUGHES	HMS 2-1149/76	TRIAX	*	*	0.215	0.020	95
HUGHES	HMS-1480/2	TWINAX	-45	—	—	—	—
HUGHES	HMS2-1149/77	TWINAX	-47	—	0.122	0.025	—
HUGHES	HMS2-1149/78	TWINAX	-27	-223	0.110	0.020	68
HUGHES	STFM1398	COAX	-41	—	0.280	0.059	50
IBM	4885584	COAX	—	-022	0.222	0.025	—
IBM	7362211	TWINAX	-8	—	0.330	0.039	—
IBM	07F9635	COAX	*	*	0.112	0.019	75
INDUSTRIA BRASILEIRA	"RF75-0,8/4,8"	COAX	*	-016	0.304	0.032	75
IN-LINE	7000	COAX	-36	-007	0.115	0.015	75
IN-LINE	7100	COAX	-21	*	0.170	0.023	75
IN-LINE	7400	COAX	-36	-007	0.115	0.015	75
IN-LINE	7600	COAX	-21	*	0.175	0.023	75

Note: \* = Special contact factory

# CABLE GROUP TABLE

CABLE MANUFACTURER	CABLE NUMBER	CABLE TYPE	WRENCH STYLE	CRIMP STYLE	JACKET SIZE	CONDUCTOR	IMPEDANCE
INTERCOMP	12402	TWINAX	*	_	0.444	0.050	_
INTERFACE CABLE	SM-A-939852	COAX	*	-010	0.159	0.030	_
INTERNATIONAL WIRE & CABLE	9091	COAX	*	*	0.239	0.052	50
JOURNEY	7001740	COAX	-5	-003	0.100	0.018	_
JPL	ST12008-24	TWINAX	_	-206	0.110	0.026	75
JPL	ST12008-26	TWINAX	*	-223	0.100	0.020	75
JUDD	740	COAX	_	-004	0.080	0.010	75
JUDD	735S01	COAX	*	-026	0.134	0.018	75
JUDD	C1401053	COAX	-63	-025	0.232	0.031	75
JUDD	C1401064	COAX	*	-026	0.132	0.016	75
JUDD	C1401741	COAX	_	-004	0.099	0.010	75
JUDD WIRE INC	SS502401	COAX	-5	-003	_	_	_
KAMERAKABEL	11MM	TRIAx	*	_	_	_	_
KAMERAKABEL	8.5MM	TRIAx	*	_	_	_	_
KEITHLEY	SC-22	TRIAx	-23	*	0.145	0.024	40
KEITHLEY	SC-9	COAX	-1	-021	0.195	0.035	50
KOVID CACTUS	8900-0007-0000	COAX	-36	105-1820 (220)	0.104	0.019	75
LAMNCASA	CECBV-75-2	COAX	-37	*	0.162	0.012	_
LINK	CVS LKRX75S2D4	COAX	-22	-009	0.157	0.020	75
LOCKHEED MARTIN	6815176	TWINAX	*	TOO LARGE	0.375	0.041	120
LOCKHEED MARTIN	ABA	TWINAX	-29	-206	0.120	0.025	_
LOCKHEED MARTIN	STM01-600 TYPE I	TWINAX	*	*	0.162	0.030	_
LOCKHEED MARTIN	STM01-600 TYPE II	TWINAX	*	-204	0.130	0.025	_
LOCKHEED MARTIN	5PTM1T04-5	TWINAX	-60	_	0.177	0.024	100
LOCKHEED MARTIN	6121176-1	TRIAx	*	_	0.121	0.012	_
LOCKHEED MARTIN	ST5M1284-003	TWINAX	-45	_	0.146	0.020	_
LUCENT	407529262	COAX	-5	-004	0.106	0.010	75
LUCENT	848068607	COAX	-37	*	0.166	0.016	75
LUCENT	106 309 206 (2734A)	COAX	_	-025	0.225	0.031	75
LUCENT	106 309 214 (2734A)	COAX	_	*	0.225	0.038	75
LUCENT	1928 001A 1C/36	COAX	*	-026	0.133	0.015	75
LUCENT	2734A R1000	COAX	_	*	0.225	0.031	75
LUCENT	2734A RVAR	COAX	_	*	0.225	0.031	75
LUCENT	2735B	COAX	_	*	0.145	0.017	75
LUCENT	735C	COAX	*	-026	0.139	0.016	75
LUCENT	KS23918 L2	COAX	_	-004	0.089	0.013	75
LUCENT	WP91681 L2	COAX	_	-004	0.089	0.013	75
M/A COM	FLC78-50J	COAX	_	_	_	_	50
M/A-COM	2250-E82832	COAX	-53	-022	_	_	_
MADISON	022H22BZID	TWINAX	-9	_	0.250	0.038	100
MADISON	0722W00001	COAX	*	_	0.114	0.019	75
MADISON	12CFE00002	COAX	_	-009	0.158	0.020	75
MADISON	12EEK00001	COAX	_	-026	0.132	0.016	75
MADISON CABLE CORP	6096	COAX	-21	*	0.158	0.037	_

Note: \* = Special contact factory

## CABLE GROUP TABLE

CABLE MANUFACTURER	CABLE NUMBER	CABLE TYPE	WRENCH STYLE	CRIMP STYLE	JACKET SIZE	CONDUCTOR	IMPEDANCE
MALCO	250-4070-0000	TRIAX	-57	-302	0.175	0.030	_
MALCO	250-4818-0009	TRIAX	*	*	0.131	0.011	50
MALCO	250-4820-0009	TRIAX	*	_	0.128	0.011	95
MALCO	295-3804-0000	TRIAX	_	-305	0.184	0.010	95
MANHATTAN	M32011	TWINAX	-47	-203	0.140	0.013	124
MANHATTAN	M4207	COAX	-6A	_	0.405	0.048	_
MANHATTAN	M4216	COAX	*	-018	0.260	0.025	_
MANHATTAN	M4227	TWINAX	-9	-213	_	_	_
MANHATTAN	M4243	COAX	-5	-004	0.94	0.012	75
MANHATTAN	M4244	COAX	*	*	0.158	0.017	75
MANHATTAN	M4276	COAX	-2	-013	0.242	0.025	93
MANHATTAN	M44209	COAX	*	*	0.158	0.032	_
MANHATTAN	M64227	TWINAX	*	_	0.227	0.037	_
MANHATTAN CDT	M4237	COAX	-2	-013A	0.242	0.030	75
MANHATTAN/CDT	M14462	TWINAX	*	-212	0.187	0.027	_
MARTIN MARIETTA	STME637-2	TWINAX	_	-206	_	_	_
MCDONNELL DOUGLAS	STD0101-01	TWINAX	*	*	0.147	0.030	
MCDONNELL DOUGLAS	HS5965	COAX	_	_	0.185	0.048	50
MCDONNELL DOUGLAS	HS4863	TRIAX	-23	-303	0.146	0.015	_
MCDONNELL DOUGLAS	HS4885	TWINAX	*	-204	0.133	0.025	_
MCDONNELL DOUGLAS	SSQ21655	TWINAX	-45	-218	0.158	0.029	_
MCDONNELL DOUGLAS	NDBC-TFE-24S2SJ-75	TWINAX	*	-201	0.130	0.023	75
MCDONNELL DOUGLAS	NRFC-50-COAX-3	COAX	*	_	0.185	0.054	50
MCDONNELL DOUGLAS	NRFC-75-SHCO-7	COAX	-2A	-023	0.220	0.035	75
MCDONNELL DOUGLAS	ST5M1298F26M2S6	TWINAX	-27	_	0.114	0.019	_
MCDONNELL DOUGLAS	5M2022-001	TWINAX	-27	-206	0.114	0.020	_
MCDONNELL DOUGLAS	5M2022-003	TWINAX	*	-204	0.130	0.024	_
MCDONNELL DOUGLAS	5M2022-008	TWINAX	-27	-206	0.114	0.020	_
MCDONNELL DOUGLAS	5M2142-001	TRIAX	*	_	_	_	_
MCDONNELL DOUGLAS	5M2397-001	TRIAX	-23	-303	0.140	0.012	_
MCDONNELL DOUGLAS	5M2397-002	TRIAX	-23	-303	_	_	_
MCDONNELL DOUGLAS	HS5930-1	TWINAX	-64	-217	0.144	0.024	77
MCDONNELL DOUGLAS	ST5M1212-001	TWINAX	-24	_	0.154	0.031	68
MCDONNELL DOUGLAS	ST5M1212-003	TWINAX	*	_	0.098	0.020	68
MCDONNELL DOUGLAS	ST5M1323	TRIAX	*	*	0.210	0.019	_
MCDONNELL DOUGLAS	STD0102-113	TWINAX	-56	*	0.170	0.037	78
MERCURY	DOD/DNA RF21	TWINAX	_	-214	_	_	_
MERITEC	700152	COAX	-44	*	0.073	0.012	
MERITEC	700279	COAX	*	-026	0.135	0.016	75
METRO OPTIX	160-00003-001	COAX	_	*	0.090	0.011	75
MICRO COAX	UFB197C	COAX	_	_	0.200	0.055	_
MICRODOT	202-3927-0000	TWINAX	-27	-208	0.110	0.011	117
MICRODOT	202-3934-0000	TWINAX	-24	-211	0.145	0.013	160
MICRODOT	202-3942-0000	TWINAX	-27	-209	0.207	0.025	110

Note: \* = Special contact factory

# CABLE GROUP TABLE

CABLE MANUFACTURER	CABLE NUMBER	CABLE TYPE	WRENCH STYLE	CRIMP STYLE	JACKET SIZE	CONDUCTOR	IMPEDANCE
MICRODOT	202-4547	TWINAX	-24	-211	0.098	0.020	160
MICRODOT	250-3833-0000	TRIAX	*	-303	0.270	0.030	—
MICRODOT	250-3834-0000	COAX	-5A	-001	0.400	0.095	50
MICRODOT	250-3836-0000	TRIAX	*	—	—	—	50
MICRODOT	250-3902-0000	COAX	-5A	-001	0.141	0.036	50
MICRODOT	250-3908-0000	COAX	-5A	-001	0.128	0.012	50
MICRODOT	250-3909-0000	COAX	-44	*	0.087	0.021	50
MICRODOT	250-3920-0000	COAX	-5A	-001	0.087	0.021	50
MICRODOT	250-3967-0000	COAX	-5	-003	0.087	0.021	50
MICRODOT	250-4021-0000	COAX	-31	*	0.245	0.035	50
MICRODOT	250-4044-0000	TRIAX	-43	—	0.245	0.033	50
MICRODOT	250-4045-0000	TRIAX	-43	-302	0.500	0.089	50
MICRODOT	250-4070-0000	TRIAX	-56	-302	0.500	0.081	50
MICRODOT	250-4172-0000	COAX	*	—	0.500	0.089	50
MICRODOT	250-4180-0000	COAX	-5	-003	0.500	0.081	50
MICRODOT	250-4208-0000	COAX	—	—	0.500	0.081	50
MICRODOT	250-4804-0000	TRIAX	-32	-203	0.105	0.012	50
MICRODOT	250-4816-0009	TRIAX	-27	—	0.145	0.013	50
MICRODOT	275-3930-000	TRIAX	—	—	0.102	0.021	75
MICRODOT	275-3933-0000	COAX	-4	-009	0.120	0.021	75
MICRODOT	275-3991	COAX	-36	*	0.200	0.038	75
MICRODOT	293-3902	COAX	*	-026	0.160	0.031	93
MICRODOT	293-3922-0000	TRIAX	-60	-305	0.200	0.039	93
MICRODOT	293-3930-0000	TRIAX	-43	—	0.336	0.057	100
MICRODOT	293-3968-0000	COAX	-22	-008	0.412	0.090	93
MICRODOT	295-3801-0000	COAX	-22	-008	0.432	0.090	95
MICRODOT	295-3802-0000	COAX	-22	*	0.432	0.090	95
MICRODOT	295-3950-0000	TRIAX	-43	—	0.216	0.036	95
MICRODOT	295-3952-0000	TRIAX	-43	—	0.075	0.013	95
MICRODOT	295-3966-0000	TRIAX	*	—	0.175	0.038	95
MICRODOT	295-3992-000	COAX	-36	-007	0.288	0.060	95
MICRODOT	295-3993-0000	TRIAX	-64	-303	0.102	0.021	95
MICROGNOSIS	MICROGNOSIS	COAX	*	-004	0.100	0.019	—
MICROPORE	190	COAX	*	—	0.400	0.090	50
MICROSTOCK	UT85-75	COAX	-86	—	0.200	0.039	75
MIDISCO	MDC8084	COAX	-86	—	0.134	0.024	75
MIL-SPEC	M17/203-00001	TWINAX	*	—	0.189	0.013	77
MILESTEK	30-01010	COAX	-2	-013	0.195	0.013	75
MIL-SPEC	2C2219EXJ	TWINAX	-47	-206	0.336	0.029	—
MIL-SPEC	LS2SJ-22	TWINAX	*	TOO LARGE	0.412	0.050	—
MIL-SPEC	M17/015-RG022	TWINAX	-10	—	0.475	0.048	95
MIL-SPEC	M17/015-RG111	TWINAX	*	—	0.246	0.024	95
MIL-SPEC	M17/094-RG179	COAX	-5	-004	0.105	0.013	75
MIL-SPEC	M17/095-RG180	COAX	-22	-008	0.145	0.013	95

Note: \* = Special contact factory

## CABLE GROUP TABLE

CABLE MANUFACTURER	CABLE NUMBER	CABLE TYPE	WRENCH STYLE	CRIMP STYLE	JACKET SIZE	CONDUCTOR	IMPEDANCE
MIL-SPEC	M17/110-RG302	COAX	*	*	0.207	0.025	75
MIL-SPEC	M17/113-RG316	COAX	-5	-003	0.098	0.020	50
MIL-SPEC	M17/116-RG307	TRIAX	*	_	0.270	0.030	75
MIL-SPEC	M17/127-RG393	COAX	*	TOO LARGE	0.400	0.095	50
MIL-SPEC	M17/128-RG400	COAX	_	_	_	_	50
MIL-SPEC	M17/130-RG402	COAX	-141	_	0.141	0.036	50
MIL-SPEC	M17/131-RG403	TRIAX	*	*	0.128	0.012	50
MIL-SPEC	M17/133-00001	COAX	-86	*	0.087	0.021	50
MIL-SPEC	M17/133-00002	COAX	-86	*	0.087	0.021	50
MIL-SPEC	M17/133-RG405	COAX	-86	*	0.087	0.021	50
MIL-SPEC	M17/134-00001	TRIAX	-7	-306	0.245	0.035	50
MIL-SPEC	M17/134-00002	TRIAX	-7	-306	0.245	0.033	50
MIL-SPEC	M17/135-00001	TRIAX	-14A	TOO LARGE	0.500	0.089	50
MIL-SPEC	M17/135-00003	TRIAX	-14A	_	0.500	0.081	50
MIL-SPEC	M17/135-00004	TRIAX	-14A	TOO LARGE	0.500	0.089	50
MIL-SPEC	M17/135-00005	TRIAX	-14A	TOO LARGE	0.500	0.081	50
MIL-SPEC	M17/135-00006	TRIAX	-14A	TOO LARGE	0.500	0.081	50
MIL-SPEC	M17/136-00001	COAX	-5	-004	0.105	0.012	75
MIL-SPEC	M17/137-00001	COAX	-22	-008	0.145	0.013	95
MIL-SPEC	M17/138-00001	COAX	-5	-003	0.102	0.021	50
MIL-SPEC	M17/152-00001	COAX	-5	-006	0.120	0.021	50
MIL-SPEC	M17/155-00001	COAX	-1	-011	0.200	0.038	50
MIL-SPEC	M17/157-00001	COAX	-4	-010	0.160	0.031	50
MIL-SPEC	M17/158-00001	COAX	-1	-012	0.200	0.039	50
MIL-SPEC	M17/162-00001	COAX	-6E	_	0.336	0.057	50
MIL-SPEC	M17/163-00001	COAX	-6A	_	0.412	0.090	50
MIL-SPEC	M17/164-00001	COAX	-6B	_	0.432	0.090	50
MIL-SPEC	M17/164-00002	COAX	-6B	_	0.432	0.090	50
MIL-SPEC	M17/167-00001	COAX	-3	-012	0.216	0.036	50
MIL-SPEC	M17/169-00001	COAX	-5A	-001	0.075	0.013	50
MIL-SPEC	M17/170-00001	COAX	-21	-011	0.175	0.038	50
MIL-SPEC	M17/171-00001	COAX	-41	_	0.288	0.060	50
MIL-SPEC	M17/172-00001	COAX	-5	-003	0.102	0.021	50
MIL-SPEC	M17/173-00001	COAX	-5	-003	0.100	0.019	50
MIL-SPEC	M17/174-00001	COAX	-6A	_	0.400	0.090	50
MIL-SPEC	M17/175-00001	COAX	-1	-012	0.200	0.039	50
MIL-SPEC	M17/176-00002	TWINAX	-47	-201	0.134	0.024	77
MIL-SPEC	M17/177-00001	TRIAX	-60	-305	0.189	0.013	95
MIL-SPEC	M17/179-00001	TRIAX	*	-305	0.195	0.013	75
MIL-SPEC	M17/180-00001	COAX	-6E	-017	0.336	0.029	75
MIL-SPEC	M17/181-00001	COAX	-6A	_	0.412	0.050	75.E
MIL-SPEC	M17/181-00002	COAX	*	TOO LARGE	0.475	0.048	50
MIL-SPEC	M17/184-00001	COAX	-2	-013	0.246	0.024	75
MIL-SPEC	M17/186-00001	TWINAX	-9 ***	-213	0.245	0.040	78

Note: \* = Special contact factory



# CABLE GROUP TABLE

CABLE MANUFACTURER	CABLE NUMBER	CABLE TYPE	WRENCH STYLE	CRIMP STYLE	JACKET SIZE	CONDUCTOR	IMPEDANCE	
MIL-SPEC	M17/187-00001	COAX	-4	*	0.160	0.031	50	
MIL-SPEC	M17/189-00001	COAX	-6A	_	0.412	0.090	50	
MIL-SPEC	M17/190-00001	COAX	-6B	TOO LARGE	0.432	0.089	50	
MIL-SPEC	M17/196-00001	COAX	-5	*	0.115	0.019	50	
MIL-SPEC	M17/200-00001	COAX	-3	-012	0.216	0.036	50	
MIL-SPEC	M17/29-RG59	COAX	-2	-013	0.245	0.023	75	
MIL-SPEC	M17/2-RG6	COAX	-6E	-017	0.336	0.029	75	
MIL-SPEC	M17/30-RG062	COAX	-2B	-013	0.250	0.025	93	
MIL-SPEC	M17/31-RG63	COAX	-6A	_	0.415	0.026	125	
MIL-SPEC	M17/45-RG108	TWINAX	-9	-213	0.235	0.038	78	
MIL-SPEC	M17/47-RG114	COAX	-6A	_	0.415	0.08	185	
MIL-SPEC	M17/60-RG142	COAX	-1	-012	0.200	0.040	50	
MIL-SPEC	M17/62-RG144	COAX	-6B	TOO LARGE	0.412	0.0525	75	
MIL-SPEC	M17/6-RG11	COAX	-6A	-053	0.412	0.050	75	
MIL-SPEC	M17/77-RG216	COAX	-6B	_	0.432	0.050	75	
MIL-SPEC	M17/84-RG223	COAX	-3	-012	0.216	0.035	50	
MIL-SPEC	M17/86-00001	COAX	-6B	_	0.440	0.094	50	
MIL-SPEC	M17/90-RG71	COAX	-2B	-015A	0.250	0.025	93	
MIL-SPEC	M17/97-RG210	COAX	-2B	-013B	0.250	0.026	93	
MIL-SPEC	M24643/33-01UN	TWINAX	*	_	0.255	0.050	75	
MIL-SPEC	M27500-22ML2T00	TWINAX	_	*	0.117	0.031	_	
MIL-SPEC	M27500-22TE2T14	TWINAX	-45	-210	0.137	0.032	_	
MIL-SPEC	M27500-22TN2N06	TWINAX	-29	-201	0.134	0.029	_	
MIL-SPEC	M27500-24S82T23	TWINAX	_	-208	0.101	0.021	78	
MIL-SPEC	MC24643/33-01UN	TWINAX	*	_	0.255	0.050	75	
MIL-SPEC	RG108/U	TWINAX	SEE MIL-SPEC M17/ CABLE # FOR ALL RG#					78
MIL-SPEC	RG11/U	COAX						75
MIL-SPEC	RG111/U	TWINAX						95
MIL-SPEC	RG114/U	COAX						185
MIL-SPEC	RG122	COAX						50
MIL-SPEC	RG13/U	COAX						75
MIL-SPEC	RG141/U	COAX						50
MIL-SPEC	RG142/U	COAX						50
MIL-SPEC	RG144/U	COAX						75
MIL-SPEC	RG174/U	COAX						50
MIL-SPEC	RG178B/U	COAX						50
MIL-SPEC	RG179/U	COAX						75
MIL-SPEC	RG180B/U	COAX						95
MIL-SPEC	RG187A/U	COAX						75
MIL-SPEC	RG188/U	COAX						50
MIL-SPEC	RG195A/U	COAX						95
MIL-SPEC	RG196A/U	COAX						50
MIL-SPEC	RG210/U	COAX						93

Note: \* = Special contact factory

## CABLE GROUP TABLE

CABLE MANUFACTURER	CABLE NUMBER	CABLE TYPE	WRENCH STYLE	CRIMP STYLE	JACKET SIZE	CONDUCTOR	IMPEDANCE
MIL-SPEC	RG212/U	COAX	SEE MIL-SPEC M17/ CABLE # FOR ALL RG#				50
MIL-SPEC	RG213/U	COAX					50
MIL-SPEC	RG214/U	COAX					50
MIL-SPEC	RG216/U	COAX					75
MIL-SPEC	RG223/U	COAX					50
MIL-SPEC	RG225/U	COAX					50
MIL-SPEC	RG22B/U	TWINAX					95
MIL-SPEC	RG302	COAX					75
MIL-SPEC	RG303/U	COAX					50
MIL-SPEC	RG304/U	COAX					50
MIL-SPEC	RG307	TRIAX					75
MIL-SPEC	RG316	COAX					50
MIL-SPEC	RG393	COAX					50
MIL-SPEC	RG400/U	COAX					50
MIL-SPEC	RG402/U	COAX					50
MIL-SPEC	RG403	TRIAX					50
MIL-SPEC	RG405/U	COAX					50
MIL-SPEC	RG55B/U	COAX					50
MIL-SPEC	RG58/U	COAX					50
MIL-SPEC	RG59B/U	COAX					75
MIL-SPEC	RG5B/U	COAX					50
MIL-SPEC	RG62A/U	COAX					93
MIL-SPEC	RG62B/U	COAX					93
MIL-SPEC	RG63/U	COAX					125
MIL-SPEC	RG6A/U	COAX					75
MIL-SPEC	RG71/U	COAX					93
MIL-SPEC	RG87A/U	COAX					50
MIL-SPEC	RG8A/U	COAX					50
MIL-SPEC	RG9B/U	COAX	50				
MOGAMI	2947	COAX		*	0.121	0.020	75
MOGAMI	2964	COAX	*	*	0.189	0.024	75
MOGAMI	3145	COAX	_	*	0.117	0.021	75
MOHAWK	5305-8	TWINAX	_	_	0.420	0.040	_
MOHAWK	HT10431 TWINAX	TWINAX	-9	-214	0.245	0.022	124
MOHAWK	HTAA328-5	COAX	*	TOO LARGE	0.347	0.064	_
MOHAWK	M52001-HT10431	TWINAX	-9	_	_	_	_
MOHAWK	M52210	COAX	_	-016	0.300	0.032	75
MOHAWK	M54426	COAX	*	-009	0.153	0.020	75
MOHAWK	M80248	TRIAX	*	TOO LARGE	0.360	0.031	75
MOHAWK	MS2001	TWINAX	*	-214	0.245	0.022	_
MOHAWK	PNHT10431	TWINAX	_	-214	0.245	0.022	124
MOHAWK WIRE & CABLE	M52057	COAX	_	-024	0.260	0.040	_
MOLEX	711530009	COAX	-5A	_	0.060	0.010	75
MOLEX	71153-3019	COAX	_	*	0.070	0.017	50

Note: \* = Special contact factory

# CABLE GROUP TABLE

CABLE MANUFACTURER	CABLE NUMBER	CABLE TYPE	WRENCH STYLE	CRIMP STYLE	JACKET SIZE	CONDUCTOR	IMPEDANCE
MONSTER CABLE	SU-RG6 CL	COAX	-41	-020	0.278	0.042	75
MONTROSE	6248	COAX	*	*	0.189	0.021	—
MONTROSE	9835-735	COAX	*	-026	0.135	0.015	75
MONTROSE	CDT 735A	COAX	—	-026	0.129	0.016	75
MONTROSE	IFX4385	COAX	—	-004	0.100	0.013	75
MONTROSE/CDT	CBL 1225	TWINAX	—	-225	0.200	0.022	124
MONTROSE/CDT	CBL 1233	COAX	-2A	-025	0.225	0.033	75
MONTROSE/CDT	CBL 1235	COAX	-2A	-025	0.235	0.031	75
MONTROSE/CDT	CBL 1288-()	COAX	—	-026	0.129	0.016	75
MONTROSE/CDT	CBL 2108	COAX	-2A	-025	0.235	0.031	75
MONTROSE/CDT	CBL 2109	COAX	-2A	-025	0.241	0.034	75
MONTROSE/CDT	CBL 2721	TRIAX	-7	-306	0.250	0.037	50
MONTROSE/CDT	CBL 2726	COAX	*	-026	0.133	0.016	75
MONTROSE/CDT	CBL 7382	COAX	—	*	0.215	0.058	50
MONTROSE/CDT	CBL 7820	COAX	-21	*	0.165	0.035	—
MONTROSE/CDT	CBL 8411	TRIAX	*	TOO LARGE	0.356	0.041	—
MONTROSE/CDT	CBL 8415	TRIAX	*	TOO LARGE	0.438	0.057	—
MONTROSE/CDT	CBL 9835-735	COAX	*	-026	0.136	0.014	75
MONTROSE/CDT	CBL 9956	TWINAX	-56	*	0.170	0.037	78
MONTROSE/CDT	CBL3340	COAX	—	-004	0.077	0.011	75
NATIONAL WIRE & CABLE	S10-9723	TWINAX	-55	-214	0.226	0.021	—
NAVAIR	67A37A130	COAX	-4	*	0.140	0.031	—
NAVAIR	67A37A130	COAX	*	—	0.135	0.031	50
NAVSEA	6322369	TRIAX	-60	—	0.188	0.029	50
NAVSEA	6322493	TRIAX	*	TOO LARGE	0.480	0.050	75
NAVSEA	6323054	COAX	*	—	0.430	0.047	75
NAVSEA	6323055	TWINAX	*	—	0.281	0.040	—
NAVSEA	6323056	TRIAX	*	—	0.291	0.038	—
NAVSEA	6323059	TRIAX	*	TOO LARGE	0.325	0.025	—
NAVSEA	6262065-1	TRIAX	*	TOO LARGE	0.437	0.089	—
NEK	51021	TRIAX	*	TOO LARGE	0.334	0.045	75
NEK	PSF 1/3M	COAX	*	-018	0.256	0.024	75
NEK CABLE	156503	COAX	-2A	-022	0.220	0.025	—
NEK CABLE	IEEE 802.3 10 BASE 2	COAX	-21	*	0.165	0.036	—
NEK CABLE	NEK 23795	COAX	-21	*	0.170	0.024	75
NEK/CDT	51041	TRIAX	*	TOO LARGE	0.325	0.046	75
NEK/CDT	HF75 0.6/3.7 HV DS	COAX	-2	-015	0.257	0.023	75
NEK/CDT	VTF8.5	TRIAX	*	—	0.335	0.041	75
NEMAL	1835F	TRIAX	*	*	0.360	0.032	75
NEW ENGLAND	N13-44B-480	TWINAX	*	—	—	—	—
NEW ENGLAND ELECTRIC WIRE	TR70748	COAX	*	*	0.262	0.030	75
NIKKAI	2.5C-FXW	COAX	*	*	0.185	0.020	—
NK NETWORKS	320784	TRIAX	*	—	0.341	0.038	75
NK NETWORKS	0.51/2.4	COAX	-4	-009	0.162	0.021	75

Note: \* = Special contact factory

## CABLE GROUP TABLE

CABLE MANUFACTURER	CABLE NUMBER	CABLE TYPE	WRENCH STYLE	CRIMP STYLE	JACKET SIZE	CONDUCTOR	IMPEDANCE
NK NETWORKS	0.58/2.6	COAX	-21	—	0.161	0.024	75
NK NETWORKS	0.5L/2.4	COAX	-4	*	0.153	0.020	75
NK NETWORKS	0.6/2.8	COAX	*	*	0.180	0.026	75
NK NETWORKS	0.6/3.7	COAX	-2B	-015	0.250	0.026	75
NK NETWORKS	0.6/3.7 DZ	COAX	-2B	-015	0.256	0.025	75
NK NETWORKS	0.6L/3.7	COAX	-2	-013	0.244	0.025	75
NK NETWORKS	0.8/3.7	COAX	—	*	0.244	0.032	75
NK NETWORKS	0.8/4.9	COAX	-51	-016	0.303	0.033	75
NK NETWORKS	1.0/4.8	COAX	—	*	0.289	0.040	75
NORCOM	28215742	COAX	—	-027	0.013	0.016	75
NORCOM	735M	COAX	—	-007	—	—	75
NORCOM/CDT	735	COAX	—	-026	0.139	0.018	75
NORCOM/CDT	28216802	735AT	—	-026	0.129	0.016	75
NORCOM/CDT	734A	COAX	—	-025	0.235	0.031	75
NORCOM/CDT	734D	COAX	—	-025	0.235	0.031	75
NORCOM/CDT	734T	COAX	—	*	0.241	0.034	75
NORCOM/CDT	735A	COAX	*	-026	0.131	0.018	75
NORDEN	154-085-0002	TRIAx	-64	—	0.145	0.012	—
NORTHERN TELECOM	NT-734	COAX	—	-025	—	—	—
NORTHERN TELECOM	NT-735	COAX	*	-026	0.130	0.016	75
NORTHROP	05A077-1	TWINAX	*	—	0.155	0.025	—
NORTHROP	05A078-1	TWINAX	*	-204	0.127	0.023	—
NORTHROP	05A077-1	TWINAX	-24	-221	0.161	0.024	—
OLFLEX	3649FD	TWINAX	—	-213	0.259	0.038	78
OLYMPIC	6254T	COAX	*	TOO LARGE	0.354	0.0105	50
OLYMPIC AVIATION	NHU-EFTXF 6.07/2.26	TRIAx	-62	—	0.449	0.091	50
OLYMPIC CABLE CORP	6273T	COAX	*	-021	0.188	0.036	—
ORION	TEF2202	TWINAX	—	*	0.196	0.029	—
PANAVIA	6421	TWINAX	-45	-204	0.135	0.025	—
PANAVIA	6595	TRIAx	-23	-303	0.141	0.012	75
PANAVIA	6425 ZA 002	TWINAX	-45	-218	0.151	0.024	—
PANAVIA	6595XM	TRIAx	-23	-303	0.137	0.012	—
PENN WIRE	25Q821	COAX	-6A	—	0.378	0.064	75
PERCON	VK6	COAX	-2	-014	0.240	0.032	75
PERENA	KX6	COAX	-2	-013	0.243	0.023	—
PIC WIRE	L8620TX	TRIAx	-60	—	0.178	0.035	—
PIC WIRE	V75268	COAX	*	*	0.127	0.020	75
PIC WIRE & CABLE	L2201TX	TRIAx	-25A	-306	0.250	0.038	50
PIC WIRE & CABLE	S33141	COAX	-41	—	0.272	0.067	—
PKI	"0,6/2,8"	COAX	*	*	0.180	0.025	75
PKI	"0,6/3,7"	COAX	-2	-019	0.237	0.023	—
PKI	"1,0/6,6"	COAX	*	TOO LARGE	0.352	0.040	—
PKI	"1,6/73 AF"	COAX	*	TOO LARGE	0.429	0.061	—
PKI KAMERAKABEL	1-Nov	TRIAx	-14	TOO LARGE	0.481	0.056	—

Note: \* = Special contact factory

# CABLE GROUP TABLE

CABLE MANUFACTURER	CABLE NUMBER	CABLE TYPE	WRENCH STYLE	CRIMP STYLE	JACKET SIZE	CONDUCTOR	IMPEDANCE
PRIME STOCK	M32011P	TWINAX	*	-203	0.151	0.010	—
PRIME STOCK	PS665PL	TWINAX	*	—	0.190	0.021	—
PRIME STOCK	PS666PL	TWINAX	-47	—	0.131	0.010	—
PRIME STOCK	M32012L	TWINAX	—	*	0.225	0.026	124
RADIALL	C291982060	TRIAX	-42	—	0.285	0.035	—
RADIO CORP OF AMERICA	852493-5	TWINAX	-29	*	0.132	0.030	—
RAYCHEM	EPD49311Q	COAX	-1	-021	0.197	0.035	50
RAYCHEM	10584	TRIAX	-24A	—	0.148	0.012	—
RAYCHEM	10586	TRIAX	-24A	—	0.148	0.012	—
RAYCHEM	10595	TWINAX	*	-204	0.133	0.025	—
RAYCHEM	10599	TWINAX	-24	-210	0.145	0.031	—
RAYCHEM	10600	TWINAX	*	-213	0.216	0.032	—
RAYCHEM	10602	TWINAX	-45	-204	0.144	0.025	—
RAYCHEM	10605	TWINAX	*	*	0.173	0.032	—
RAYCHEM	10606	TWINAX	*	-223	0.117	0.021	75
RAYCHEM	10612	TWINAX	*	-204	0.128	0.025	77
RAYCHEM	10613	TWINAX	*	-222	0.154	0.025	77
RAYCHEM	10614	TWINAX	-24	-221	0.161	0.025	77
RAYCHEM	0024A0024	TWINAX	-24	-217	0.152	0.025	100
RAYCHEM	0026A0024	TWINAX	*	—	—	0.019	100
RAYCHEM	0528A0424	TWINAX	-47	—	0.116	0.015	105
RAYCHEM	10598-30-9X	TRIAX	*	-303	0.148	0.012	—
RAYCHEM	10612-24-9	TWINAX	*	-204	0.132	0.027	77
RAYCHEM	1301-TZD 101 06 UX	TWINAX	-55	-204	0.217	0.024	—
RAYCHEM	13317 12515	TWINAX	*	—	0.091	0.019	—
RAYCHEM	2012M3612	COAX	*	TOO LARGE	0.310	0.089	50
RAYCHEM	2024D0014	TWINAX	*	—	0.210	0.025	120
RAYCHEM	2524A0424	TWINAX	*	-212	0.172	0.025	125
RAYCHEM	2524A1311	COAX	*	TOO LARGE	0.404	0.024	125
RAYCHEM	2.52E+117	TWINAX	—	*	0.190	0.025	125
RAYCHEM	2524E0311-9	TWINAX	*	-224	0.201	0.025	125
RAYCHEM	2524F0524	TWINAX	*	-218	0.148	0.025	125
RAYCHEM	2524K0524	TWINAX	-55	-224	0.194	0.025	125
RAYCHEM	2526D1114	TWINAX	*	-219	0.144	0.019	125
RAYCHEM	2526E1114	TWINAX	-24	-219	0.147	0.019	125
RAYCHEM	2530A0314	TWINAX	-27	-208	0.105	0.012	125
RAYCHEM	2530A1317	COAX	-63	—	0.203	0.013	125
RAYCHEM	26433/30147K	TWINAX	*	*	0.091	0.019	—
RAYCHEM	30-03101	TWINAX	*	—	0.110	0.029	—
RAYCHEM	44M9996-20-2/6-0	TWINAX	-24	*	0.157	0.039	—
RAYCHEM	5012A3311	COAX	-50	—	0.350	0.088	50
RAYCHEM	5012M3612	COAX	*	TOO LARGE	0.301	0.089	50
RAYCHEM	5012W5812	TRIAX	-61	*	0.437	0.089	50
RAYCHEM	5020A1311	COAX	-4	*	0.155	0.040	50

Note: \* = Special contact factory

## CABLE GROUP TABLE

CABLE MANUFACTURER	CABLE NUMBER	CABLE TYPE	WRENCH STYLE	CRIMP STYLE	JACKET SIZE	CONDUCTOR	IMPEDANCE
RAYCHEM	5020A1811	COAX	-21	*	0.165	0.039	50
RAYCHEM	5020A3422	COAX	*	*	0.169	0.039	50
RAYCHEM	5020A3612	COAX	*	*	0.153	0.040	50
RAYCHEM	5021D1331	COAX	*	-021	0.188	0.035	50
RAYCHEM	5021H5331	TRIAX	-25A	_	0.258	0.035	50
RAYCHEM	5022D5112	TRIAX	-43	_	0.175	0.032	50
RAYCHEM	5022D5311	TRIAX	-43	_	0.175	0.032	50
RAYCHEM	5022E5111	TRIAX	-57	-302	0.164	0.033	50
RAYCHEM	5024A1311	COAX	-36	*	0.104	0.025	50
RAYCHEM	5024A1661	TWINAX	-27	*	0.108	0.025	50
RAYCHEM	5024A3111	COAX	-5	-003	0.113	0.019	50
RAYCHEM	5024A3314	COAX	*	*	0.127	0.025	50
RAYCHEM	5026A1111	COAX	-44	_	0.080	0.019	50
RAYCHEM	5026A1614	COAX	-44	_	0.080	0.019	50
RAYCHEM	5026A1664	TWINAX	-49	*	0.085	0.019	50
RAYCHEM	5026A5624	TRIAX	*	*	0.130	0.019	50
RAYCHEM	5026D5314	TRIAX	-23	_	0.132	0.019	50
RAYCHEM	5026N5611	TRIAX	*	_	0.124	0.019	50
RAYCHEM	5028A2211-9	COAX	-44	_	_	0.013	50
RAYCHEM	5028A3318	COAX	-5B	-004	0.090	0.014	50
RAYCHEM	5028D5312	TRIAX	*	_	0.110	0.013	50
RAYCHEM	5030A1114	COAX	-5A	-001	0.061	0.012	50
RAYCHEM	5030A1214	COAX	-5A	_	0.061	0.012	50
RAYCHEM	5030A1314	COAX	-5A	_	0.063	0.012	50
RAYCHEM	5030A1318	COAX	-5A	_	0.063	0.012	_
RAYCHEM	5030A1411	COAX	-5A	_	0.066	0.012	50
RAYCHEM	5030A1511	COAX	-5A	_	0.066	0.012	50
RAYCHEM	55A1121-24	TWINAX	-27	-223	0.107	0.025	_
RAYCHEM	55A1122-26	TWINAX	*	-223	0.102	0.021	_
RAYCHEM	7028A5518	TRIAX	-26	_	0.143	0.015	70
RAYCHEM	7518A0811	TRIAX	*	TOO LARGE	0.480	0.050	75
RAYCHEM	7518A5611	TRIAX	*	TOO LARGE	0.324	0.054	75
RAYCHEM	7518A5811	TRIAX	*	TOO LARGE	0.417	0.052	_
RAYCHEM	7520A1311	COAX	-52	-024	0.241	0.040	75
RAYCHEM	7522A1311	COAX	_	-023	_	_	75
RAYCHEM	7522A1312	COAX	_	*	0.194	0.032	75
RAYCHEM	7522A1811	COAX	*	*	0.210	0.032	75
RAYCHEM	7522A5811	TRIAX	*	_	0.258	0.030	75
RAYCHEM	7522D5311	TRIAX	-25A	_	0.269	0.031	75
RAYCHEM	7523D1331	COAX	-2	-013	0.246	0.023	75
RAYCHEM	7524A1311	COAX	-21	_	0.160	0.025	75
RAYCHEM	7524A1312	COAX	-22	_	0.152	0.025	75
RAYCHEM	7524A1811	COAX	-37	_	0.152	0.025	75
RAYCHEM	7524D5011	TRIAX	*	*	0.200	0.025	75

Note: \* = Special contact factory

# CABLE GROUP TABLE

CABLE MANUFACTURER	CABLE NUMBER	CABLE TYPE	WRENCH STYLE	CRIMP STYLE	JACKET SIZE	CONDUCTOR	IMPEDANCE
RAYCHEM	7524D5111	TRIAx	*	*	0.195	0.025	75
RAYCHEM	7524D5811	TRIAx	_	-306	0.243	0.025	_
RAYCHEM	7526A5311	TRIAx	-60	_	0.215	0.019	75
RAYCHEM	7526D5318	TWINAx	-59	_	0.167	0.020	75
RAYCHEM	7526J1660	TWINAx	-47	_	0.115	0.019	75
RAYCHEM	7528A1114	COAx	-36	-004	0.100	0.015	75
RAYCHEM	7528A1317	COAx	-5	-004	0.102	0.015	75
RAYCHEM	7528A5314	TRIAx	-64	-303	0.148	0.015	75
RAYCHEM	7528F5614	TRIAx	*	-303	0.141	0.015	75
RAYCHEM	7528G1312-7	COAx	-36	*	0.110	0.015	_
RAYCHEM	7530A5218	TRIAx	*	*	0.117	0.013	75
RAYCHEM	7530A5314	TRIAx	*	_	0.129	0.012	75
RAYCHEM	7530A5524	TRIAx	*	*	0.130	0.012	75
RAYCHEM	7720C8662	TWINAx		-213	_	0.020	77
RAYCHEM	7722C2664	TWINAx	-24	-210	0.143	0.032	77
RAYCHEM	7722C3661	TWINAx	-24	*	0.178	0.032	77
RAYCHEM	7722C3861	TWINAx	*	-215	0.232	0.031	77
RAYCHEM	7722D1161	TWINAx	*	*	0.075	0.032	77
RAYCHEM	7724C1664-9	TWINAx	*	-204	0.127	0.023	77
RAYCHEM	7724C3864	TWINAx	*	-212	0.200	0.024	77
RAYCHEM	7724C8664	TWINAx	*	-221	0.155	0.025	_
RAYCHEM	7724G3664	TWINAx	-45	-222	0.154	0.025	77
RAYCHEM	7724N0664	TWINAx	-45	-204	0.144	0.025	78
RAYCHEM	7726D066A	TWINAx	-27	-223	0.112	0.020	77
RAYCHEM	7820D0111	TWINAx	*	_	0.182	0.040	78
RAYCHEM	7824D0130	TWINAx	*	_	0.172	0.025	78
RAYCHEM	7824E0422	TWINAx	-29	-204	0.135	0.025	78
RAYCHEM	7826D0130	TWINAx	-29	-206	0.120	0.025	78
RAYCHEM	9324D0130	TWINAx	*	212	0.167	0.025	93
RAYCHEM	9528A1317	COAx	*	-026	0.137	0.015	95
RAYCHEM	9528A1417	COAx	*	-026	0.137	0.015	95
RAYCHEM	9528A1517	COAx	*	-026	0.137	0.015	95
RAYCHEM	9528D5114	TRIAx	-60	-305	0.177	0.015	95
RAYCHEM	9530A5117	TRIAx	-24A	_	0.149	0.012	_
RAYCHEM	9530D5117	TRIAx	-56	-301	0.164	0.013	95
RAYCHEM	9530D5317	TRIAx	-59	_	0.170	0.012	95
RAYCHEM	9530H1118	COAx	-36	_	0.108	0.013	95
RAYCHEM	9532A5114	TRIAx	-23	_	0.140	0.008	95
RAYCHEM	9532A5314	TRIAx	-23	_	0.130	0.008	95
RAYCHEM	EPC29116C	TRIAx	-32	-309	0.152	0.017	_
RAYCHEM	EPD 30881A	TWINAx	*	*	0.201	0.024	77
RAYCHEM	EPD 60441	TRIAx	-25A	TOO LARGE	0.256	0.035	50
RAYCHEM	EPD22030E	TWINAx	*	-224	0.209	0.026	_
RAYCHEM	EPD22030F	TWINAx	_	-215	0.251	0.025	_

Note: \* = Special contact factory



## CABLE GROUP TABLE

CABLE MANUFACTURER	CABLE NUMBER	CABLE TYPE	WRENCH STYLE	CRIMP STYLE	JACKET SIZE	CONDUCTOR	IMPEDANCE
RAYCHEM	EPD22188B	TWINAX	_	-218	0.150	0.025	_
RAYCHEM	EPD26467Q	TRIAX	-23	-303	0.136	0.012	_
RAYCHEM	EPD27364A	TWINAX	-11	TOO LARGE	0.311	0.038	77
RAYCHEM	EPD29102A	COAX	-2	-013	0.243	0.023	75
RAYCHEM	EPD29697A	TWINAX	*	_	0.165	0.025	_
RAYCHEM	EPD30653Q	TWINAX	*	-217	0.150	0.025	_
RAYCHEM	EPD33017Q	COAX	-5	-003	0.106	0.020	_
RAYCHEM	EPD33698Q	TRIAX	-32	_	0.142	0.015	_
RAYCHEM	EPD33727Q	TRIAX	-33	_	0.185	0.012	_
RAYCHEM	EPD38474Q	TRIAX	-13	TOO LARGE	0.330	0.022	_
RAYCHEM	EPD43297	TWINAX	*	_	0.465	0.040	_
RAYCHEM	EPD44692	TWINAX	-29	-217	0.146	0.025	77
RAYCHEM	EPD45673	TRIAX	*	_	0.254	0.023	75
RAYCHEM	EPD46145Q	TRIAX	*	TOO LARGE	0.323	0.023	_
RAYCHEM	EPD46270Q	TRIAX	-9	-306	0.260	0.037	_
RAYCHEM	EPD49317Q	COAX	-63	_	0.228	0.025	75
RAYCHEM	EPD49334Q	TRIAX	-8	TOO LARGE	0.322	0.023	75
RAYCHEM	EPD49336Q	TRIAX	-13A	TOO LARGE	0.322	0.023	_
RAYCHEM	EPD49338Q	TWINAX	-9	_	_	_	_
RAYCHEM	EPD60947Q	TRIAX	-7	_	0.260	0.042	_
RAYCHEM	EPD6314	TWINAX	-29	-201	0.136	0.025	77
RAYCHEM	EPD6344-22-9CS1833	TWINAX	_	*	0.195	0.030	_
RAYCHEM	EPD647100-01	COAX	-6B	TOO LARGE	0.433	0.088	50
RAYCHEM	EPD67364Q	TRIAX	*	TOO LARGE	0.268	0.032	75
RAYCHEM	EPD71818A	TWINAX	*	*	0.264	0.025	_
RAYCHEM	EPD7246Q	COAX	-6A	TOO LARGE	0.406	0.048	75
RAYCHEM	EPD76761	TWINAX	_	-212	0.177	0.024	77
RAYCHEM	EPD78310	TRIAX	*	*	0.208	0.035	50
RAYCHEM	EPD8274-1	TRIAX	-13	TOO LARGE	0.314	_	_
RAYCHEM	EPD84067	TRIAX	*	_	0.301	0.035	50
RAYCHEM	M27500-22ML2TO8	TWINAX	-45	-204	0.134	0.028	_
RAYCHEM	M27500-22RC2S06	TWINAX	*	-217	0.145	0.025	_
RAYCHEM	M27500-26RC2S06	TWINAX	-47	-223	0.110	0.019	_
RAYCHEM	M27500-26RC2S09	TWINAX	-27	_	0.110	0.018	_
RAYCHEM	URM54	TRIAX	-13	_	0.327	0.023	_
RAYDEX/CDT	RLF7	COAX	*	*	0.295	0.073	50
RAYDEX/CDT	RA7000	COAX	-21	*	0.177	0.026	75
RAYDEX/CDT	RA750-8CORE	COAX	_	-026	0.139	0.012	_
RAYTHEON	979268	TRIAX	-24A	-307	0.189	0.012	75
RAYTHEON	10271188	TRIAX	-23	_	0.131	0.09	_
RAYTHEON	11464169	TWINAX	-55	*	0.214	0.038	78
REMEE	1575	COAX	_	*	0.295	0.041	75
ROCKBESTOS	RSS-6-104	COAX	-2	_	0.242	0.032	_
ROCKBESTOS	RSS-6-154	COAX	-2	-014	0.242	0.032	75

Note: \* = Special contact factory

# CABLE GROUP TABLE

CABLE MANUFACTURER	CABLE NUMBER	CABLE TYPE	WRENCH STYLE	CRIMP STYLE	JACKET SIZE	CONDUCTOR	IMPEDANCE
ROCKWELL	LE572-0003-0008	TWINAX	*	-204	0.132	0.026	77
ROCKWELL	LE572-0035	TRIAX	-23	_	0.135	0.015	75
ROCKWELL	MP572-0279-0002	TWINAX	-29	-201	0.125	0.025	_
ROCKWELL	MP572-0328-0002	TWINAX	-29	-204	0.130	0.025	_
SABRITTEC	540-1050-000	TRIAX	-23	TOO SMALL	0.127	0.014	_
SAXTON	8405	COAX	-2B	-013A	0.249	0.030	93
SAXTON	8421F	COAX	-6B	TOO LARGE	0.425	0.091	50
SCC	3901/018/52	TWINAX	*	-201	0.125	0.027	90
SCI	41	COAX	-44	*	0.074	0.012	75
SEIMENS	2YCICY 0.63/3.7-75	TRIAX	-13A	TOO LARGE	0.307	0.025	75
SEMFLEX	BPE400	CAOX	*	-050 (90)	0.409	0.0110	
SEMFLEX	FSCM 60637	COAX	*	*	0.123	0.026	50
SEMFLEX	SW110	COAX	*	*	0.123	0.026	50
SENSORMATIC	K0100-0106-006	COAX	*	*	0.193	0.032	_
SEQUOIA	1000NS1V	COAX	-31	_	0.120	0.040	_
SIECOR	8712812	TWINAX	-47	-201	_	_	_
SIEMANS-GERMANY	O2YCICY-1.2/5.7-75LIGR	TRIAX	*	_	0.430	0.047	_
SONIC WIRE	28/736TFCXECXE	TRIAX	-32	_	0.142	0.014	_
SOUTH BAY CABLE (SBC)	SB-39602 REV C	COAX	*	TOO LARGE	0.423	0.054	_
SPF	KX8	COAX	-6A	TOO LARGE	0.400	0.050	_
STANDARD WIRE/CABL	1100-66F	TWINAX	-45	-210	0.145	0.032	_
STORM	34-001	TRIAX	-59	_	0.175	0.019	50
STORM	34-003	TRIAX	*	_	0.113	0.012	50
SUHNER	G 04233 D-10	COAX	-2B	*	0.256	0.023	75
SUHNER	G01330HT	TRIAX	-56	_	0.177	0.016	_
SUHNER	G02262	COAX	-5	-003	0.110	0.019	_
SUHNER	G02330HT	TRIAX	*	_	0.210	0.020	_
SUHNER	G02332	TRIAX	-26	_	0.167	0.035	_
SUHNER	G02333	TRIAX	-59	_	0.169	0.010	_
SUHNER	G03233D	COAX	-3	_	0.212	0.017	_
SUHNER	G04233D	COAX	*	_	0.260	0.023	_
SUHNER	GX03272D-06	COAX	-3	-012	0.213	0.035	_
SUHNER	S02223	COAX	_	-004	0.100	0.04	75
SUHNER	S04233	COAX	-2B	-014	0.243	0.034	75
SUMIRE	4C-HEB-NL	COAX	_	-25	0.236	0.035	75
SUMITOMO	2.5C	COAX	-22	-008	0.154	0.015	_
SUMITOMO	2C	COAX	*	-008	0.147	0.012	_
SUPERIOR	FVP224	TWINAX	-9	-214	0.242	0.021	_
SUPERIOR ESSEX	SERIES 11	COAX	-6A	-052	0.400	0.060	75
SURPRENANT	M16878/4-BDE-2ST	TWINAX	-27	_	0.111	0.020	_
SURPRENANT	4236	COAX	*	_	0.160	0.017	_
SURPRENANT	9872	COAX	-22	-009	0.145	0.017	_
SURPRENANT WIRE & CABLE	C-01-1317/1A	TWINAX	*	-212	0.169	0.025	78
SYLVANIA (GTE)	19-805709-1	COAX	*	*	0.085	0.012	

Note: \* = Special contact factory

## CABLE GROUP TABLE

CABLE MANUFACTURER	CABLE NUMBER	CABLE TYPE	WRENCH STYLE	CRIMP STYLE	JACKET SIZE	CONDUCTOR	IMPEDANCE
SYLVANIA (GTE)	73-1317911-1	TWINAX	-27	-208	0.110	0.011	
SYNERGISTIC RESEARCH	E102194	COAX	-2A	-023	0.235	0.032	75
SYNERGY	VIDEO 1000	COAX	_	-013	_	_	75
TELEDYNE	14796/1	TWINAX	-10	TOO LARGE	0.420	0.036	_
TELEDYNE	5M2022-002	TWINAX	*	_	0.161	0.030	_
TELEDYNE	ST5M1322-001	TRIAX	-24A	_	0.165	0.024	_
TELEDYNE THERMATICS	5M2559-001	TRIAX	*	-309	0.150	0.015	_
TELEFONICA	3623G01	COAX	-22	-026	0.138	0.015	75
TENSOLITE	92607	TRIAX	*	*	0.215	0.019	_
TENSOLITE	8712812	TWINAX	-47	-201	_	_	_
TENSOLITE	10047-9219-01	TRIAX	-32	-302	0.166	0.031	_
TENSOLITE	1936-TX-10C2SW	TWINAX	-47	-201	0.129	0.024	_
TENSOLITE	24453/42810 Q-2	QUADRAX	-58	-217	0.145	0.025	_
TENSOLITE	24499/898X2	TWINAX	-24	-204	0.125	0.025	_
TENSOLITE	26433/9P175T-2	TWINAX	-27	-205	0.090	0.019	_
TENSOLITE	26840/9D099LV-2	TWINAX	*	-223	0.110	0.019	_
TENSOLITE	28883/31169Q-1	TRIAX	-23	_	0.135	0.015	75
TENSOLITE	28883/T290TX-1	TRIAX	-23	_	0.135	0.015	75
TENSOLITE	30852/9B2581V-1 28GA	COAX	-5A	-001	0.079	0.010	_
TENSOLITE	30880/4119X-1	COAX	-44	*	0.073	0.011	_
TENSOLITE	30895/25L-1	TRIAX	60	_	_	_	_
TENSOLITE	5M2142-001	TRIAX	*	_	_	_	_
TENSOLITE	5M2397-002	TRIAX	-23	-303	0.136	0.014	_
TENSOLITE	5M2559-001	TRIAX	*	_	0.160	0.015	_
TENSOLITE	5M2870-22C2J	TWINAX	*	*	0.100	0.029	_
TENSOLITE	E6372429	TWINAX	*	_	_	_	_
TENSOLITE	S280W502	TWINAX	-24	-218	0.154	0.023	_
TENSOLITE	ST5M1284-001	TWINAX	*	-212	0.180	0.024	96
TENSOLITE	STME637-2	TWINAX	_	-206	_	_	_
TEXAS INSTRUMENTS	417889-2	TRIAX	*	-307	0.185	0.012	93
TEXAS INSTRUMENTS	802857-1	TWINAX	-24	*	0.162	0.031	70
THERMATICS	11079	TWINAX	-29	-204	0.130	0.025	_
THERMATICS	11421	TWINAX	_	-223	0.104	0.019	_
THERMATICS	11421	TWINAX	_	-223	_	_	_
THERMATICS	425-1680-030VW-1	COAX	_	-013	_	_	_
THERMATICS	5M2022-003	TWINAX	*	-204	0.130	0.024	_
THERMATICS	8712812 (A/F DWG)	TWINAX	-47	-201	0.125	0.023	_
THERMATICS	NEC725-2(G)	COAX	53	_	_	_	_
THERMAX	68-1938TF(2)SXE	TWINAX	_	-223	0.104	0.019	_
THERMAX	77-1936TF(2)TFPA	TWINAX	-47	-201	0.125	0.024	77
THERMAX	947-494	COAX	*	*	0.159	0.040	_
THERMAX	983-495	COAX	-4	*	0.144	0.024	75
THERMAX	985-495	COAX	-4	*	0.144	0.024	75
THERMAX	M27500-22TG2T14	TWINAX	-29	_	0.132	0.031	_

Note: \* = Special contact factory

# CABLE GROUP TABLE

CABLE MANUFACTURER	CABLE NUMBER	CABLE TYPE	WRENCH STYLE	CRIMP STYLE	JACKET SIZE	CONDUCTOR	IMPEDANCE
THERMAX	MCD-THI	TWINAX	*	—	—	—	125
THERMAX	RG58/BLACK	COAX	-1	-011	—	—	50
THERMAX	RGS-316	COAX	-5	-003	0.102	0.020	50
THERMAX	RGS-316	COAX	-5	-003	0.102	0.020	50
TIMES	2382	COAX	-6A	—	0.400	0.064	75
TIMES	2391	COAX	-41	-020	0.273	0.041	75
TIMES	2560	COAX	-41	—	0.271	0.040	—
TIMES	68999	TRIAX	*	—	0.335	0.026	—
TIMES	8712812	TWINAX	-47	-201	—	—	—
TIMES	100A	COAX	-5	-003	0.105	0.018	50
TIMES	2240V	COAX	*	*	0.262	0.032	75
TIMES	2260V	COAX	-6	*	0.296	0.040	75
TIMES	2360V	COAX	-41	-020	0.273	0.040	75
TIMES	25B3M	COAX	-2	-014	0.242	0.031	—
TIMES	65555-RD316	COAX	-5	-003	0.113	0.021	—
TIMES	AA-2317	TRIAX	-24A	*	0.169	0.025	50
TIMES	AA-2325	TRIAX	*	-308	0.215	0.020	95
TIMES	AA-2511	COAX	-2A	—	0.220	0.020	—
TIMES	AA-3096	COAX	-34	—	0.242	0.050	—
TIMES	AA-3369	TWINAX	—	—	—	—	78
TIMES	AA-4668.2	COAX	-2	*	0.236	0.051	—
TIMES	AA-4888	TRIAX	-64	-303	0.145	0.013	75
TIMES	AA-5885	COAX	*	—	0.480	0.0134	—
TIMES	AA-5886	COAX	*	—	0.390	0.0105	—
TIMES	AA-5887	COAX	*	*	0.270	0.067	50
TIMES	AA-6045	TWINAX	—	—	—	—	78
TIMES	AA-6151	TRIAX	-64	—	0.143	0.012	75
TIMES	AA-6343	COAX	-1	-011	0.193	0.037	—
TIMES	AA-6894	TRIAX	*	TOO LARGE	0.480	0.050	75
TIMES	AA-6895	TRIAX	*	TOO LARGE	0.450	0.089	—
TIMES	AA-6899	COAX	-6B	—	0.434	0.064	75
TIMES	AA-7028	TWINAX	-9	-215	0.240	0.028	—
TIMES	AA-7032	COAX	-6E	-017	0.332	0.029	—
TIMES	AA-7038	COAX	-2	-013	0.242	0.023	—
TIMES	AA-7279	TWINAX	-10	TOO LARGE	0.425	0.046	—
TIMES	AA-7618	COAX	*	—	0.430	0.047	75
TIMES	AA-7621	TRIAX	*	TOO LARGE	0.325	0.025	—
TIMES	AA-7740	COAX	—	*	0.160	0.036	50
TIMES	AA-7740	COAX	—	*	0.160	0.036	50
TIMES	AA-7741	COAX	-5	-003	0.100	0.020	50
TIMES	AA-7909	TWINAX	*	—	0.155	0.019	—
TIMES	AA-8314	TWINAX	*	*	0.115	0.012	—
TIMES	AA-8469	COAX	—	-004	0.242	0.059	50
TIMES	AA-8624	COAX	-31	-005	0.121	0.012	75

Note: \* = Special contact factory

## CABLE GROUP TABLE

CABLE MANUFACTURER	CABLE NUMBER	CABLE TYPE	WRENCH STYLE	CRIMP STYLE	JACKET SIZE	CONDUCTOR	IMPEDANCE
TIMES	AA-8699	TRIAX	*	_	0.110	0.012	_
TIMES	BL1242	TWINAX	-9	-216	0.245	0.022	_
TIMES	BL782	TWINAX	-9	-213	0.245	0.039	78
TIMES	BL784	TWINAX	-10	TOO LARGE	0.420	0.067	78
TIMES	BL982	TWINAX	-9	-215	0.245	0.032	_
TIMES	LMR-100A	COAX	-36	-026	0.124	0.019	50
TIMES	LMR195	COAX	-3	-011	0.197	0.038	50
TIMES	LMR-200	COAX	-1	_	0.190	0.045	50
TIMES	LMR240	COAX	*	*	0.240	0.059	50
TIMES	LMR-240-LLPL	COAX	_	_	0.240	0.051	50
TIMES	LMR-300	COAX	-6	*	0.300	0.070	50
TIMES	LMR400	COAX	*	-050 (90)	0.409	0.110	_
TIMES	LMR-500	COAX	*	TOO LARGE	_	_	50
TIMES	LMR-600	COAX	*	_	0.590	0.176	50
TIMES	M17/182-00001	TWINAX	-10	TOO LARGE	0.425	0.046	_
TIMES	MI2240V	COAX	*	*	0.272	0.032	_
TIMES	MI4007	COAX	*	-026	0.138	0.017	_
TIMES	MI-655555	COAX	-5	*	0.115	0.021	_
TIMES	RD-316	COAX	-31	-006	0.118	0.020	50
TIMES	RDT-302	TRIAX	-25A	_	0.260	0.025	_
TIMES	RDT-316	TRIAX	-26	_	0.155	0.020	50
TIMES	RT-142	TRIAX	*	_	0.215	0.039	_
TIMES	RT-179	TRIAX	-64	-303	0.145	0.012	75
TIMES	RT-180	TRIAX	*	_	0.191	0.025	_
TIMES	RT-302	TRIAX	-25	*	0.242	0.026	75
TIMES	RT-316	TRIAX	*	_	0.154	0.020	50
TIMES	RT-400	TRIAX	*	*	0.215	0.020	_
TIMES	SF-142B	COAX	-1	-011	0.195	0.037	50
TIMES	SF-214	COAX	-6B	_	0.425	0.089	_
TIMES	SF-304	COAX	*	_	0.290	0.059	50
TIMES	TRF-58	TRIAX	-7	-306	0.250	0.039	50
TIMES	TRF-59	TRIAX	-13	TOO LARGE	0.325	0.023	_
TIMES	TRF-8	TRIAX	-14A	_	0.500	0.086	50
TIMES FIBER	2644	COAX	-6A	TOO LARGE	0.400	0.064	75
TIMES FIBER CABLE	173	COAX	-51	-016	0.308	0.033	75
TIMES FIBER COMM (TFC)	23T2	COAX	-6A	_	0.400	0.064	75
TIMES MICROWAVE	405	COAX	-36	-003	0.104	0.020	50
TIMES MICROWAVE	AA-8371	TRIAX	*	*	0.210	0.036	50
TIMES MICROWAVE	AA-8746	COAX	*	*	0.131	0.028	50
TIMES MICROWAVE	LMR200LLPL	COAX	-1	-011	0.195	0.040	50
TOSHIBA	NHU-EFTXF 6.07/2.26	TRIAX	*	TOO LARGE	0.457	0.090	50
TROMPETER	M17/176-00002	TWINAX	-47	-201	0.134	0.024	77
TROMPETER	QRC- 78-1	QUADRAX	39	_	TBD	0.022	78
TROMPETER	QRC- 78-2	QUADRAX	17	_	0.286	0.040	78

Note: \* = Special contact factory

# CABLE GROUP TABLE

CABLE MANUFACTURER	CABLE NUMBER	CABLE TYPE	WRENCH STYLE	CRIMP STYLE	JACKET SIZE	CONDUCTOR	IMPEDANCE
TROMPETER	QRC- 78-3	QUADRAX	38	_	0.325	0.039	78
TROMPETER	QRC-124-1	QUADRAX	40	_	TBD	0.012	124
TROMPETER	QRC-124-3	QUADRAX	38	_	0.335	0.022	124
TROMPETER	TCC-50-2	COAX	-1	-011	0.199	0.038	50
TROMPETER	TCC-75-2	COAX	-2	-013A	0.246	0.031	75
TROMPETER	TCC-75-3D	COAX	_	*	0.185	0.024	75
TROMPETER	TCC-75-3S	COAX	_	*	0.185	0.024	75
TROMPETER	TCC-75-4D	COAX	_	*	0.145	0.019	75
TROMPETER	TCC-75-4S	COAX	_	*	0.145	0.019	75
TROMPETER	TRC-50-1	TRIAX	-32	-309	0.161	0.015	50
TROMPETER	TRC-50-2	TRIAX	-7	-306	0.250	0.038	50
TROMPETER	TRC-75-1	TRIAX	-33	-307	0.194	0.012	75
TROMPETER	TRC-75-2	TRIAX	-7	-308	0.250	0.019	75
TROMPETER	TRCH-50-2	TRIAX	-7	-306	0.250	0.038	50
TROMPETER	TRCH-75-1	TRIAX	_	_	0.250	0.012	75
TROMPETER	TWAC-78-1F1	TWINAX	_	_	_	_	_
TROMPETER	TWAC-78-1F2	TWINAX	-49	-205	0.100	0.015	78
TROMPETER	TWC-124-1A	TWINAX	-29	-203	0.155	0.012	124
TROMPETER	TWC-124-2	TWINAX	-9	-214	0.250	0.022	124
TROMPETER	TWC-78-1	TWINAX	-29	-202	0.155	0.022	78
TROMPETER	TWC-78-2	TWINAX	-9	-213	0.247	0.037	78
TROMPETER	TWCF-78-1	TWINAX	-29	-202	0.155	0.022	78
TROMPETER	TWCH-78-1	TWINAX	-29	-202	0.155	0.022	78
TROMPETER	TWCH-78-2	TWINAX	-9	-213	0.247	0.037	78
TROMPETER	TWCN-124-1A	TWINAX	-29	-203	_	_	_
TROMPETER	TWCP-124-2	TWINAX	-9	-214	0.250	0.024	124
TROMPETER	TWCP-124-3	TWINAX	-55	-224	0.215	0.024	124
TROMPETER	TWCP-124-5	TWINAX	*	-226 (70MC)	0.335	0.048	124
TROMPETER	TWCP-78-1	TWINAX	-29	-202	0.155	0.021	78
TROMPETER	TWCP-78-1	TWINAX	-47	_	0.155	0.019	78
TROMPETER	TWCP-78-2	TWINAX	-9	-213	0.247	0.037	78
TVA	F660BVV	COAX	-41	-020	0.267	0.042	75
TVE	92	TRIAX	*	TOO LARGE	0.433	0.054	_
UK	BICC T3304	COAX	-2B	-015	0.252	0.024	_
UK	BICCT(M)3205	COAX	_	-016	_	_	_
ULRICH HEER	VIM222-318/97	TRIAX	-23	_	0.138	0.012	75
UNICABLE	ICN417-2052P	COAX	*	*	0.162	0.036	_
UNICABLE	IEEE 802.3A	COAX	-21	*	0.171	0.039	_
UNK	PCC-FTS	COAX	*	*	0.213	0.034	75
UNK	TR17901	TRIAX	-23	-303	0.140	0.011	_
UNK	VCB 100	COAX	*	*	0.279	0.049	_
UNK	VCB 75	COAX	-2	-023	0.238	0.034	75
URM 102	RAYCHEM	COAX	*	TOO LARGE	0.382	0.099	50
USAF	8712812	TWINAX	-47	-201	_	_	_

Note: \* = Special contact factory

## CABLE GROUP TABLE

CABLE MANUFACTURER	CABLE NUMBER	CABLE TYPE	WRENCH STYLE	CRIMP STYLE	JACKET SIZE	CONDUCTOR	IMPEDANCE
VCS	PSF1/3	COAX	*	-018	0.260	0.020	75
VDO	711-PAN 6421	TWINAX	-45	—	—	—	—
VIDEO TIME S.P.A.	RX75/56	TRIAX	*	TOO LARGE	0.437	0.054	—
VIDEOKABEL	0.6/3.7	COAX	-2	-022	0.237	0.025	75
VOLEX	DXSN 1530	COAX	—	*	0.087	0.016	75
VOUGHT AERONAUTICS	202-2964-222	TRIAX	-57	—	—	—	—
WEICO	55222	TWINAX	*	-217	0.145	0.025	—
WEST PENN	812	COAX	-1	-011	0.195	0.037	52
WEST PENN	814	COAX	-53	-019	0.232	0.025	75
WEST PENN	815	COAX	-2A	-023	0.232	0.032	75
WEST PENN	816	COAX	-2	-023	0.239	0.030	75
WEST PENN	819	COAX	-2A	-023	0.232	0.032	75
WEST PENN	825	COAX	-22	-009	0.146	0.018	75
WEST PENN	841	COAX	—	-024	0.254	0.041	75
WEST PENN	843	COAX	-2	-014	0.242	0.032	75
WEST PENN	3815	TRIAX	-13	TOO LARGE	0.330	0.032	75
WEST PENN	25806	COAX	*	*	0.236	0.040	75
WEST PENN	25806	COAX	*	*	0.236	0.041	75
WEST PENN	25815	COAX	*	—	—	0.032	75
WEST PENN	25819	COAX	*	*	0.207	0.032	75
WEST PENN	25825	COAX	—	*	0.146	0.018	75
WEST PENN	25841	COAX	—	-024	0.254	0.040	—
WEST PENN	28515	COAX	*	*	0.207	0.032	—
WEST PENN	CL2Q843	COAX	-34	*	0.248	0.032	—
WEST PENN	HD825	COAX	—	-009	0.150	0.019	75
WEST PENN	P806	COAX	-6	-016	0.305	0.032	75
WEST PENN	Q841	COAX	*	*	0.283	0.041	75
WEST PENN CABLE	818	COAX	-2A	-014	0.242	0.031	75
WEST PENN WIRE	6350	COAX	—	-020	0.275	0.040	75
WESTINGHOUSE	128C147H01	TRIAX	-26	—	0.165	0.012	—
WEST PENN	25821	COAX	*	—	0.352	0.064	75
WEST PENN	25Q841	COAX	-41	-020	0.273	0.040	75
WHITMORE	24002001	TRIAX	-23	-303	0.142	0.012	75
WOVEN ELEC	T19TPSJ2619EN	TWINAX	-27	-208	0.105	0.012	—
YAMADA	AMB/A-C2-11-2-9	TWINAX	—	-201	0.135	0.025	—
Z MICROSYSTEMS	CTL3VGAMM	COAX	-36	-004	0.100	0.015	75

Note: \* = Special contact factory



## SPACE-QUALIFIED CONNECTORS

### Outgassing Requirements for Space Rated Connectors

Trompeter has a long and proud history of servicing space applications. NASA uses the specification (SP-R-0022), Vacuum Stability Requirements of Polymeric Material for Space Application, to qualify materials for use in spacecraft. This has also become the standard in the commercial space industry. This specification governs the “outgassing” of non-metallic materials. Outgassing occurs when a non-metallic material is placed into a vacuum, subjected to heat, and some of its constituents are volatilized.

One of the bi-products of outgassing is that the material loses a portion of its mass. This is referred to as Total Mass Loss, or TML. Under the NASA specification, the material’s TML should not exceed 1.0% of the total specimen mass. This issue is very important because shrinkage may contribute to the failure of a connector as the connector components will no longer fit properly.

Another bi-product of outgassing is Collectable Volatile Condensable Material (CVCN). This represents the quantity of outgassed matter that condenses and collects on a surface. Under the NASA specification, the maximum condensable material allowed is 0.1% of the total specimen mass. This is very critical in a thermal/vacuum environment because it is the condensed material that will contaminate optical and sensory surfaces causing them to possibly fail.

Some polymeric materials meet the requirements of a TML less than 1.0% and CVCN of less than 0.1% through the normal manufacturing process. Other polymeric materials, while not within limits after their manufacture, can be brought within vacuum stability limits by vacuum baking for a specific period of time (usually 48 hours at maximum use temperature at a pressure less than 10<sup>-5</sup> torr). If a material cannot be vacuum baked, its exposure area is 13cm<sup>2</sup> or less, and is out of sight of a payload or other critical surfaces, then a TML not greater than 3.0% and a CVCN not greater than 1.0% is acceptable.

Test conditions are ASTM E-595 or ASTM F-1227. The test consists of heating a sample to 125°C for 24 hours under a 10<sup>-5</sup> torr vacuum and measuring the weight loss and any material that condenses on an adjacent cold surface area (25°C). The most common candidates for outgassing in Trompeter product lines include:

1. **Silicon rubber per ZZ-R-765E/GEN (Federal Spec), Class 2B, Grade 40, 50, 60, and 70.** Almost all of Trompeter’s gaskets are manufactured from this material. These materials require a post process (by Trompeter) at 200°centigrade for 6 hours minimum.
2. **Ink.** Trompeter uses Markem™ series 7224 inks (in a variety of colors) for part marking. Only blue 7224 Markem ink has acceptable TML (0.43%) and CVCN (0.07%) readings after a post cure process. While this is acceptable, Trompeter recommends impression stamping the connector rather than ink marking.
3. **Shrinkable strain relief/sealing sleeve.** Sleeves made from Kynar™ material meets the requirement for outgassing at 0.14% TML and 0.02% CVCN.
4. **Insulators.** At Trompeter, the majority of dielectric insulators are made from PTFE. (Teflon™ is Dupont’s trademark for PTFE, FEP, and PFA fluoropolymer resins). PTFE has excellent TML (0.07%) and CVCN (0.01%) readings. The loss rate is about one-tenth of the acceptable maximum rates for spacecraft uses.

*For a list of connectors which meet outgassing requirements, contact our technical support staff.*

## DIGITAL SIGNAL INTEGRITY, PRINTED CIRCUIT BOARD DESIGN & THE INTERCONNECT INTERFACE AT MICROWAVE FREQUENCIES

*Article written by Dale Reed (VP Sales & Marketing, Trompeter/Semflex)*

In the world of electronics hardware, one perspective is to categorize the various pieces of the mix as (1) components and (2) connecting elements that hook components together. From this vantage, components include integrated circuits, resistors, capacitors, and other devices that “do something to” or “because of” the electronic signal. The connection element is the set of transmission lines that enable the functionality of these components. (While wireless transmission lines do exist, for the purposes of this article our focus is with wired or “wire line” transmission lines). Interconnects are the junction between the device and the transmission line. Some are separable (involving connectors) and some are not (solder joints). All are potentially degrading to the success of the transmission line.

There are two fundamental types of wired transmission lines used in digital signal transport, whether they are from component to component or from device to device. Differentiated by the physics involved, they are (1) light pulsed on or off (fiber) and (2) an electrical sine wave, shaped by using the harmonics of the wave form to look like a square wave (copper). Fiber has proven to be a wonderful high capacity solution for long haul transport of digital data signals because it offers dramatically higher distance without requiring costly amplification or signal regeneration. The application of wave division multiplexing utilizes frequency stacking technology, a trick from the copper world, to give fiber bandwidth an additional boost. The downside of fiber is that, since the digital signal exists in “on/off” conditions of the source laser, the binary code requires conversion to its electrical counterpart before it is useful for logic devices like programmed integrated circuits. This is referred to as the OEO conversion (OEO=electrical/optical/electrical). We understand now that the hype and promise of the pure photonics end-to-end optical network is likely a decade off, largely because logic and switching/routing functions remain best solved in copper technology for both technical and economic reasons. Copper technology, while mature, provides virtually all of the component-to-component and the lions’ share of the device-to-device transmission line assignment.

To be sure, as line rates rise in frequency and in data rate (interrelated), new problems have surfaced. The signal limits of copper are now better understood than ever before, and this article explores some of those limitations, how they are overcome, and suggests that progress will continue in this field.

When engineers talk about higher frequency signal lines, they often characterize their needs in terms of “S” parameters. Ever wonder what the “S” in “S parameters” stands for? Some of us think it is “scatter”. One way to view the signal line performance at a transition is to think of the transition as being in a box. Then picture the effects of a less-than-perfect transition as scattered signals — referred to as attenuation, return loss, ingress (EMI from outside) and cross talk — from an adjacent signal line.

- Attenuation is another name for signal loss, usually over distance. Obviously, without adequate signal strength, the ability to distinguish signal from noise may be compromised. Losses show up as radiation in signal or heat. At higher frequencies, the electromagnetic field that surrounds the signal movement becomes important, as does the dielectric material that this field moves through. Selecting materials with a low dielectric constant and resulting high propagation velocity becomes desirable.
- Return loss has mostly to do with impedance mismatch, typically at the interconnection points. Return loss is a signal reflected back on itself and may be a source of data errors as ones and zeros in the digital data stream are confused.
- Ingress involves outside interference. Without proper designed-in shielding, any transmission line runs the risk of becoming an antenna and picking up spurious noise.
- Cross-talk is the effect that one signal line’s electromagnetic field has on an adjacent signal line (an inducted signal).

In managing a high frequency signal with copper wire line technology, the best signal line is symmetrical with regard to spacing from the active trace to the ground, with a known low loss material in between. This is coax. In a perfect world, the material in coaxial transmission lines would be air, but as it is difficult to keep spacing accurate without a “solid” material, use of structural materials such as polyethylene, polytetrafluoroethylene, and other dielectric materials provides structure with managed signal performance degradation. The material selected depends on the frequency involved, the best solid material is polytetrafluoroethylene or PTFE.

# DIGITAL SIGNAL INTEGRITY, PRINTED CIRCUIT BOARD DESIGN & THE INTERCONNECT INTERFACE AT MICROWAVE FREQUENCIES

Most point-to-point interconnection of electronic elements is accomplished on printed circuit boards (PCBs). The PCB supports the components and provides the transmission lines between them, using etched traces of copper “on “ the PCB in lieu of discrete wires.

With the increasing use of high frequency board-level packaging for wireless telecommunications applications, it is important to remember that “wireless” phenomena occurs on the PCB itself. For example, two closely spaced adjacent traces might be designed to produce electromagnetic fields to function as a coupler. In another case, a series of cascading patches will function as a band pass filter component at microwave frequencies. (Twisted pair is a very cost effective solution to low-end high frequency RF transmission line problems. Without the twist, the cross talk problems between the pairs would be huge, particularly since they are so closely spaced. This is pretty hard to do on a PCB, however.)

High frequency electronics is one situation where size matters. At 100 MHz (i.e., the clock rate on the “standard” Pentium chip of 1996) the wavelength is several meters long. Even the harmonics, those odd multiples of the fundamental wave that allow it to become “square” and exhibit a far faster rise time for that crisp on/off condition, are low frequency. Low enough, in fact, that the full sinusoidal wave is usually larger than the PCB carrying the wave. At 1 GHz, the wave is only 10 inches long and the harmonics of the waveform are only 2 inches if the 5th harmonic is considered.

At the board level, digital signal integrity is currently being accomplished with the use of exotic laminate materials, a change from the low cost workhorse FR4 that has been the standard choice for the last 4 decades. High performance laminate suppliers have introduced improved products that address many of the inherent difficulties like co-efficient of thermal expansion issues in the z-direction, dimensional stability, and cost that dogged previous product offerings.

It is useful to remember that, until recently, the market was dominated by the military industry’s emphasis on electrical/ electromagnetic performance over low cost assembly technology or low cost materials. Currently, the need for multi-layer high frequency materials and high reliability plated thru hole (pth) applications is met with a series (is series the correct description?) of new, highly engineered polytetrafluorethylene-based-but-heavily-filled laminate products. These materials solve z-axis pth co-efficient of thermal expansion (CTE) mismatches with copper plated into the via plated thru holes. A recent development in this area is the affordability of the new laminates, approximately \$2/sq foot for FR4, compared to the older class of high performance PTFE-based exotic microwave laminates that were in the range of \$100/sq foot. New laminate products, including some that are not PTFE-based, have tackled the cost agenda and several good candidates are emerging in the \$8/sq foot range.

At higher frequencies, new complex board-level engineering issues arise. For example, the tidy 90 degree turns that digital designers use to conserve routing space on the board are destructive to high frequency performance, causing VSWR problems. One high frequency effect of this conventional pcb board layout practice is return loss reflection that cancels the incoming signal due to being 180 degrees out of phase. This can be solved by using mitered corners or by using a radius to the transition.

In addition, the length of traces relative to each other becomes important as designers try to match phase on the board. Etch precision becomes critical for lateral perfection, and in-trace-pinholes are not allowed. Even the cross-sectional geometry (trapezoid or hourglass) of the trace becomes important as conductor “skin effects” become dominate with rising frequency.

## DIGITAL SIGNAL INTEGRITY, PRINTED CIRCUIT BOARD DESIGN & THE INTERCONNECT INTERFACE AT MICROWAVE FREQUENCIES

At elevated frequencies, feature size and the precision of that feature matter. Since the three key variables to a given transmission line are conductor-to-ground spacing, dielectric constant, and conductor characteristics - the simultaneous precision of these three things is paramount to achieving the demanding “budgets” for variation. On PCB etched flat conductors, for example, it is not uncommon to have fairly “fat” trace widths of 20 mils but with  $\pm 0.0006$  tolerance overall as measured at the trace flair. And tolerances for dielectric constant of the laminate itself is usually held to 2 decimal places!

Coax is best replicated by stripline design on a PCB. Stripline, however, has major drawbacks in the level of difficulty with fabrication of the PCB itself and the corresponding cost. Over the years, designers have learned to make use of a related approach known as copper-backed co-planar micro strip PCB design, also referred to as “micro strip”.

Micro strip rides on the surface of the board and can be thought of as 70% or so of a stripline. While the top electromagnetic fields are open to radiation ingress and egress, the signal impact is largely predictable and can be managed. For example, the use of solder mask for coverage of surface traces is a workhorse approach in surface mount technology (SMT) assembly. In an RF design, the broad use of solder mask has a degrading impact on micro strip transmission lines, since the solder mask itself has uncertain dielectric constant attributes and uncertain thickness. How is this solved? One answer is solder dams that minimize the use of the mask yet still provide the assembly function of “damming” the trace to prevent solder from wicking down during reflow. These dams need only have a 20 mil footprint to do their job, and the micro strip function is nearly untouched by their presence in this size configuration.

At elevated frequencies, transitions are very important to minimize return loss. One of the most challenging transition is getting the high frequency signal on and off of the PCB itself. Connectors are a necessary evil and almost always a source of signal degradation as the frequency increases. Separable connectors are greater culprits than solder joints or similar permanent connections.

At this point, our discussion of signal limits gets specific. It may be that there are no known signal limits in frequency, other than cost. But cost is a big one. As frequency rises, the wave size shrinks and the physical geometries needed to support the wave shrink. Remember that on our PCB, etched traces become narrow, vias become even smaller, dielectrics become tight-toleranced, and lumped element features become so tight that fabrication cost is impacted.

While the issues are difficult regarding high frequency signal line management using wired transmission lines and, more importantly, where they transition from one platform to another (i.e., PCB to coaxial cable), the talent of our collective engineering personnel and the things they think of continues to amaze. ■

# SIGNAL TRANSMISSION IN HIGH FREQUENCY/HIGH DENSITY APPLICATIONS

One way to characterize the electronics market is to break it into two segments, components and interconnects. Within the interconnect segment, some signals require ground shielding, stripline and coax, for example, and some do not. Ground-shielded signals are needed:

- to protect the interior signal wire from signal degradation or loss utilizing a specific dielectric material most adjacent to the signal wire;
- to geometrically contain or ground the electromagnetic field associated with electromagnetic wave propagation; and/or
- to shield the signal from external noise or radiation, either via leakage or induction, including the fields created by adjacent wired energy, which is called crosstalk.

Within the shielded interconnects segment, there are hard wired interconnects and disconnectable interconnects. It is the latter type that is the topic of discussion here, where technology drivers and performance issues will be presented.

## Technology Drivers

The customer-driven need for more function and content, as evidence in the next-generation Pentium microprocessors and more widespread use of the Web, is driving corresponding requirements for system bandwidth, signal density and signal clarity.

Because bandwidth has become such an important issue, fiber or light-based signal transmission is now a viable technology, replacing copper-based electronic signals in many instances. However, because the end termination manifolds of light energy still must be a manageable junction of discreet clean/fast signals, the need for disconnectable copper interconnects has actually increased.

In addition, using digital technology to achieve some of these transmission objectives requires an even greater degree of fault-free interconnect performance. What was once a slight rise in background static on an analog signal at low frequency becomes the loss of an entire stream of binary information in high frequency digital technology.

As wires have progressed from point-to-point continuity paths to transmission lines, so connectors have had to accommodate the performance nuances of higher frequency and density. More information is being moved more rapidly on smaller waveforms, and the resulting demand on connection is proportional.

## Electrical Performance Issues

The most effective connectors are those that, once inserted in a transmission line, disappear. That is, they behave as if there were no connector pair present and the cable and the transmission characteristics of the line predominate. In order to achieve this state, the losses at the connector junction should be equal to or less than the losses in the transmission line.

## Frequency and Wavelength

Since wavelength and frequency are inversely related by the constant “c” (speed of light in a vacuum), at higher frequencies, the wavelengths become smaller. For example, in free space, the wavelength at 1MHz is approximately 300m or 980'; at 300MHz, it is 1m or 39"; and at 1GHz, it is 30cm or 1.2". This reduced wavelength begins to approach typical electrical component length, and at higher frequencies, it becomes significant.

By experience, the effect of a connector is usually of minimal significance until its length approaches approximately 5 percent of wave length being passed. In a physical transmission system, waves do not travel the speed of light due to the drag of the dielectric and conductor losses. For example, for typical connector and copper cable construction, the velocity of propagation is approximately 67 percent of “c”, which corresponds to an effective reduction in wavelength from approximately 39" at 300MHz to approximately 26". Five percent of this length is approximately 1.3", which is about the length of a typical RF connector pair.

**Attenuation.** Attenuation is the total amount measured in decibels by which power received is less than power transmitted after a device has been inserted, with corrections for frequency. Also called insertion loss, attenuation applies to an entire connector/cable system. It is the sum of the following four components:

1. copper loss, or resistance, in the conductors;
2. dielectric losses, as a result of the dielectric having high but not infinite resistance, therefore dissipating some energy;
3. reflection losses, due to some of the signal being reflected at various discontinuity; and
4. radiation losses, where the line acts like an antenna and radiates electromagnetic energy at high frequency.

For connector characterization within microwave systems frequencies (in the few hundred megahertz and well into the gigahertz range) the reflection copper losses are the most significant. Other losses present are primarily a result of the cable assembly or design.

Figure 1.

### Frequency's Effect on Return Loss

Condition	Measured Impedance (avg.)	Return Loss		
		1-20 MHz	20-300 MHz	0.300-1 GHz
1. (75/50)	60.7Ω	>30 dB	23.7 dB	7.1 dB
2. (75/~75)	68.4Ω	>30 dB	24.5 dB	12.4 dB
3. (75/75)	73.7Ω	>30 dB	25.4 dB	21.5 dB



# SIGNAL TRANSMISSION IN HIGH FREQUENCY/HIGH DENSITY APPLICATIONS

## Impedance

An inherent characteristic for transmission lines is impedance, which is measured in ohms. Impedance is the ratio of voltage to current in a traveling wave. For a "loss-less" cable, it can be defined in terms of the ratio of inductance to capacitance. In a coaxial construction, it can be alternatively defined as a function of geometry and material properties of the dielectric material between the concentric conductors. This equation can be stated as:

$$Z_0 = \frac{138}{\sqrt{\epsilon}} (\text{Log}_{10} D/d)$$

$Z_0$  = character impedance  
 $\epsilon$  = dielectric constant of the insulation material  
 $D$  = inside diameter of the outer conductor  
 $d$  = outside diameter of the inner conductor

Physically, impedance can be thought of as the value of resistance that, when connected between the center conductor and shield at the end of the cable, makes the cable appear infinitely long. The most efficient transmission of electrical power, hence maximum signal transfer, occurs when the distributed component impedance matches that of the system.

Impedance mismatch creates a reflected wave of energy, which can be measured and stated in different forms. By defining a reflection coefficient ( $\rho$ ), which is the reflected voltage divided by incident voltage, the measure of reflection losses can be stated as:

$$\begin{aligned} \text{Reflection Loss} \\ (\text{dB}) &= 10 \text{Log}_{10} (1 / 1 - \rho^2) \text{ dB} \\ \text{or} \\ \text{Voltage Standing Wave Ratio} \\ (\text{VSWR}) &= (1 + \rho) / (1 - \rho) \end{aligned}$$

Return loss is the decibel loss due to reflection, and VSWR is a unitless ratio relating incident voltage to reflected voltage. These commonly used terms that quantify the loss associated with reflection are two scales for the same characteristic. They can be equated as follows:

$$\text{Return Loss (dB)} = 20 \text{Log}_{10} \{ (\text{VSWR} + 1) / (\text{VSWR} - 1) \}$$

Reflection losses are a function of frequency — increasing with increasing frequency — and impedance mismatch. It is helpful to note that VSWR is the ratio of the maximum standing wave voltage to the minimum standing wave voltage. VSWR, therefore, is infinite for total reflection (i.e. 0 minimum voltage) and is 1.0 for perfect transmission (no reflection). The closer to unity, the better the impedance match and the more efficient the transmission system.

## Three Examples

Figure 1 (on page 144) shows comparison return loss data from 1 MHz through 2 GHz for the following three scenarios:

1. 75Ω system (includes cable and test set); 50Ω BNC connector;
2. 75Ω system; approximate 75Ω BNC connector; and
3. 75Ω system; "true" 75Ω BNC connector.

From this, it is clear that the return loss degrades as a function of the frequency and also as a function of the extent of the impedance mismatch between the connector and cable. At higher frequencies the impedance match becomes more critical.

Other factors influence the reflection loss as well. These include: the homogeneity of a composite dielectric material; the even dispersion of air within and around a dielectric; and the "smoothing" of the mechanical transmissions between the impedance mismatches within the connector. This includes the tandem increase or decrease in sizing of the diameters for the inner and outer conductor, as well as the effect of chamfers/ breaks at sharp transitions.

## Other Considerations

Aside from the electrical and electromagnetic performance issues, connectors that disconnect should be capable of toughness, durability and robust in-field use with high counts of repeat mating cycles without failure or interruption. Other nonelectrical performance measures of importance are insertion force and retention force, particularly after repeated matings.

## Conclusion

### Market Trends, Technical Considerations and Practical Examples for Shielded Disconnectable Interconnects

Market needs are impacting electrical and electromagnetic demands on connector performance. A basic understanding of the physics involved in electrical circuit design and transition lines is necessary to appreciate the impact of losses associated with the connector. This understanding includes resistance, capacitance, inductance, efficiency, reflection losses associated with impedance mismatch, and dielectric losses associated with the materials used for connector dielectrics.

Impedance mismatch between the source, cable and connector is less significant at lower than at higher frequencies. However, as system content and speed increases, the permissible fault tolerances goes down dramatically. In other words, one impact of high technology is greater dependence on tighter tolerance quality and part-to-part repeatability. These discoveries have caused shifts in sourcing, as buying companies mature in their appreciation for robust design engineering and fabrication excellence. The connector industry is not immune from this development. ■

# ELECTRONIC SYSTEMS WIRING & CABLE

After buying the most expensive “end” equipment, many systems engineers have difficulty in determining the best methods of cabling and interconnecting for the routing of signals with minimal loss, degradation and noise pickup. Simple solutions such as selecting the correct cable, eliminating common mode grounds or physically separating long runs of parallel cables will help make the difference between a good or bad system. It must be emphasized that these good practices must be implemented at the time of initial design and are almost impossible to implement after the system is built. This “interface” engineering will be discussed in following sections titled “Signal Degradation” and “Noise.”

The systems engineer should study his system parameters and noise environment before selecting his cabling and connector components. Consideration must be given to:

- Signal frequencies
- Voltage and power levels
- Tolerable losses and degradation
- Reflected signals due to discontinuity
- Noise from direct contact common mode and ground loop returns, or radiated stray magnetic and capacitive fields.

Circuit wiring and cabling are susceptible to the pickup of noise, and all low voltage signal and data wiring should be shielded irrespective of the frequency to be transmitted. Coax cable (primarily designed to carry RF) is excellent for digital data transmission. It is relatively inexpensive (RG58, RG122, etc.) and many complete series of coax connectors are readily available.

High speed and broadband digital data must use RF (radio frequency) coax transmission cable since the fast rise time narrow pulse has harmonics reaching into the RF region. For higher frequencies, coax cable **must** be used for point-to-point wiring since it has the transmission characteristics, flexibility and economy necessary for most systems.

## Impedance Standards of Coax Cables

The most efficient impedance to use when transmitting a signal (considering only the voltages, currents and powers to be transmitted) is 75 ohm. The *telephone industry*, followed by the *TV industry*, uses 75 ohm almost exclusively for the transmission of voice, video, and data.

The *military services* were faced with a differing need for low radiation angle *omnidirectional antennas* during the period 1920 through 1940 for broadcasting ship to ship, airport tower to low flying aircraft, and base station to ground troops. The only antenna that would fill that need was the *vertical ground plane antenna* (in its many forms) with transmissions at 50 ohm. The military standardized on 50 ohm impedance and spent vast sums of money developing cables and connectors for all of their coax systems. The current general connector standard is MIL-C-39012 (primarily for 50 ohm usage).

The 93 ohm cable was developed to address the need for a *low-capacitance instrumentation* coax cable. By removing some of the coax dielectric and substituting air in the RG59 cable, the distributed capacitance was lowered, thereby creating a lower voltage loss transmission medium (RG62 cable).

More sophisticated cables and connectors of twinax, triax and quadax are now available. These newer components improve external noise rejection and containment of classified signals.

## Signal Degradation

Signal degradation in any transmission medium usually consists of voltage amplitude reductions, wave shape changes, phase or delay changes, or power losses where power is transmitted. In most systems the interconnecting cable is the longest transmission path and its selection, manufacture, testing and installation should be carefully considered. Cable should not be randomly selected and installed.

When selecting cable from specifications, always consider the length of the cable run, heat exposure, frequency and power to be transmitted vs. the acceptable losses inherent in the cable, the external noise fields and frequencies to be anticipated or encountered. Also consider the availability of connectors to terminate the cable. Too small a cable will always be cause for excessive losses. Fast rise time digital pulses will have the leading edge distorted due to the high resistance “skin” effect of small coax cables. When selecting a cable for a long run, observe the insertion loss to assure that your signal gets to its destination without too much loss.

**When in doubt select a larger cable!** Incomplete copper coverage in the outer braid over the dielectric will cause transmission line losses and affect the cable's susceptibility to signal leakage or noise pickup. A copper braid coverage 90% is preferred. Skimping on the quality of the copper braid will affect the cable's loop resistance and its “line” and “transfer” impedance. As a good rule of thumb, if the dielectric is visible through the braid (without bending the cable) then the cable should not be used.

Unseen manufacturing faults produce signal path impedance changes or discontinuity which can only be detected by “frequency sweeping” the cable. TV broadcasters have encountered as high as 60 dB losses in short runs due to periodicity and other manufacturing faults that are only detectable by swept frequency testing techniques. RG59, RG62, and other coax cables use copper weld wire for the center conductor. Copperweld is a high resistance steel wire with a copper cladding on the outside and was originally intended to give strength to TV cables when suspended from poles or pulled through ducts. However this steel wire will increase the cable attenuation on a long run (particularly at the lower frequencies) due to the high resistance of the copper clad steel. RG59 and RG62 have approximately 44 ohms per 1000 loop feet as compared to 17 ohms when using pure copper for the same size center conductor. It is also difficult to effectively crimp a center contact pin on the hard steel copperweld wire.



## ELECTRONIC SYSTEMS WIRING & CABLE

Many cable defects are not readily visible and may not show up without proper testing. The reputation of the manufacturer, the type, quantity and quality of material used is more important than cost savings in selecting coax cable.

Be careful that cable does not support heavy equipment or is subject to prolonged exposure to heat in system installations. Do not bend cable beyond the manufacturer's recommended bend radius in order to avoid producing cable discontinuity. Try to space high signal level or power circuits separate from low signal level cables when routing cables.

Signal cables are usually manufactured with polyethylene which is adequate for normal use. Teflon™ dielectric and sheathed cables should be used where high heat or chemical action will attack poly cables (such as in aircraft or industrial plants). The National Fire Underwriters now requires non-fire supporting cable to be used for all open wiring in public buildings (*plenum wiring*). Fire insurance rates can be greatly reduced in computer, nuclear accelerator and other large installations if TFE or FEP cables are used.

All transmission cable manufacturers should provide the electronic characteristics of their cables (including power handling and attenuation per foot versus frequency) to aid the system design engineer in doing a proper job. For instance, RG58C has the following characteristics if built to military specifications:

Attenuation in dB per 100 foot length  
(Ambient temperature 100°F in free space at sea level)

Frequency MHz	50	100	200	400	1K	3K	5K
Attenuation	3.3	4.9	7.4	12	24	54	83
Power (Watts)	450	300	200	135	80	40	20

Note how quickly the cable becomes unusable at the higher frequencies. Lowering the dielectric constant of the dielectric with Teflon™ or foamed Teflon™ and silver plating the inner and outer conductors to increase the skin effect conductivity will greatly improve the high frequency usage. The increase in performance justifies the additional cost. Keep in mind that for a 10 dB loss, only 3/10ths of the transmitted voltage will show up at the receiving end, and only 1/10th of the generated power will be available. (Assuming a reasonably good impedance match.) If the operating temperature is higher than the rated temperature or if the cable is used at high altitudes, the attenuation and power handling capacity should be derated.

Low-priced cable should be carefully considered. Any reduction in the amount of copper in the conductors or in the quality of materials used throughout will effect performance. Many manufacturers provide better performance in their smaller cables by using materials better than minimum Mil Specs require. Cable performance will also degrade with time and can be adversely affected by the environment where it is installed (sun, ozone, salt, sulphur products, etc.). A cable's shielding effectiveness versus the signal frequency to be transmitted should also be considered where noise pickup can be a problem. It is usually financially and physically impossible to undo any damage or replace cables once they are installed and terminated.

All RG59 cables are *not* the same. By adding the word "Type" a manufacturer may bypass minimum spec requirements to reduce pricing. Some manufacturers build a "better than Mil Spec" cable and supply a superior product. They *also* must use the word "Type" since they *exceed* or *deviate* enough from the electrical and mechanical specifications. (This also applies to connectors). Be cautious of "low bid" surplus dealers, distributors, or packaging houses. Inventoried cable may deteriorate with time. The design engineer and installation technician must be aware of the many hidden and unknown cable properties that may be detrimental to the system's performance. Buyers accepting low bids may burden engineers and technicians with future problems due to hidden deficiencies.

### Coax Cable Connectors

Any connector must be able to interconnect with very low DC series resistance (less than 10 milliohms). The impedance of a connector is usually of no consequence below approximately 300 MHz. The connector does not contribute to circuit performance until the signal length approaches 1/20th of a wavelength. 50 ohm connectors can be attached to 75 ohm *video cables* with little detrimental effect. **However, the effect of a connector on a signal is cumulative.** Coax connectors should be impedance matched to the system impedance for frequencies above 300 MHz.

The generation of *intermodulation* and nonlinear distortion caused by the presence of ferromagnetic material in the conductor has become a more prominent factor in the selection of cables and connectors. **Heat treated beryllium-copper should be used for critical contact springs** to maintain contact resilience. Many manufacturers use ordinary brass which soon loses its contact pressure and the connector becomes noisy or fails.

The systems engineer can no longer afford to take connectors for granted. He must be aware of cable characteristics such as attenuation, phase displacement, and transfer impedance. The systems engineer must also understand the inherent characteristics of the many connector families available and the strengths and weaknesses of individual manufacturers' connector designs. He must be willing to expend the time and effort to specify the quality component his system demands.

The many types and series of coax connectors presently available can cause confusion for users. Many of the lesser known series were designed to address specific problems or were developed by commercial companies for their own proprietary product line. The connector series listed below have gained universal acceptance due to their simplicity and performance. They are produced and stocked by the majority of coax connector manufacturers.

Nominal Cable Size O.D.	Connector Size	Quick Disconnect	Threaded
.060 to .425	Standard	C	N
.060 to .425	Miniature	BNC	TNC
.060 to .225	Subminiature	TPS	TCM

Much can be written to discuss the advantages of one series of connectors over another. Selection is normally based on cost or performance depending upon the system parameters required.

# ELECTRONIC SYSTEMS WIRING & CABLE

## Connector Attachment : Crimping or Soldering

Crimping is normally used where the speed of attachment is important or where it is virtually impossible to solder due to lack of power (as on the top of a telephone pole or in a cable vault). A special crimp tool quickly and simply installs the connector to the cable. Repair requires a new connector for replacement. Soldering, on the other hand, does not require any special tool. A soldered connection will not corrode provided adequate heat is correctly applied to avoid a “cold solder joint.” Some soldered coax connectors may be used over without special tools or replacement parts. This is advantageous on shipboard or in field locations where replacement parts or tools are not always available.

## Noise

Electrical noise is by definition, any unwanted interfering voltage, developed within or externally to a system, which reduces the performance of that system. "Noise" has always been a problem and in the past was usually reduced by brute-force filtering which reduced or stopped "noise" after it had entered the system. This method was quite expensive, but reasonably effective since signal information voltages were low in frequency and systems were few and not too large or complex.

Present day *communication* and *data systems* are continually becoming larger, more numerous and use higher information rates and frequencies in an atmosphere of expanded electrical and electronic equipment usage. The net result is ever increasing levels of interference and noise which creates an electronic traffic jam of major proportions. This applies equally to *low level analog* and *digital pulse systems*. Filtering is practically useless (or in some cases, completely unusable) since it produces excessive deterioration of the desired pulse waveforms or inaccuracies and distortion of analog signal voltages. Noise reduction is best accomplished by simply stopping "noise" before it enters the system.

The following describes how external noise is introduced into systems by the equipment interconnecting wiring, and the improvements that can be realized by installing noise-rejecting type cables and applying good equipment isolation and grounding techniques.

Most electronic equipment does not produce random noise and usually performs the singular task it is designed to do. Unwanted noise is picked up by the interconnecting wiring through the direct contact action of ground loops and common mode returns, or by inductive and capacitive pickup of nearby radiated fields. A desired signal in one circuit can be noise to another. Interference can be produced by local circuits within the system or from equipment completely removed and external to the system. Conversely, cables can radiate the signal they are carrying into adjacent circuits (cross-talk), generating interference to other data systems or causing security compromises in classified military communications. This problem can be further compounded by poor cable-to-equipment impedance matching which produces signal reflections and high standing wave ratios. Poorly selected and

installed cabling can act as both transmitting and receiving antenna or as undesired primary and secondary windings of coupling transformers, placing interference into the system.

Systems are often designed, fabricated, and installed using the simplest multi-wire cable or grounded coax between equipment, racks, and buildings, not realizing that they will probably encounter and pick up all manner of interference. Nearby electrical equipment such as high power radar, broadcast stations, power distribution mains, fluorescent lighting, arcing motors, teletype and communications circuits are but a few of the noise makers. The lower the system signal voltage level, the greater is the susceptibility to this outside interference.

A system design might work fine on paper or when initially assembled and tested. But it may not perform as anticipated when installed at its final location on ship or shore. You may realize that the completed system has picked up much noise and hum, or is itself radiating interference so heavily that the equipment is unusable. Costly additional effort, parts, and time expended to locate and attempts to eliminate the causes of the noise pickup may meet with little success. Cable-to-equipment interface engineering should be applied at the start of system planning and design to avoid this unnecessary waste. This applies to all systems for low or high frequency signals, for applications in **TV, telemetry, timing, ordnance, environmental testing, computer, telephone, test instrumentation, or normal communications**. Each system must be considered individually, since the signal frequencies and amplitudes within the system and the anticipated external interference will dictate what type of cabling and connection techniques are to be used.

## Examples of Good Cable Engineering

*Low-level environmental systems* predominantly use “guarded” balanced and shielded lines to transmit the calibrated transducer test voltage to an isolated charge amplifier.

*TV video* is distributed over 124-ohm “shielded twisted pair” (twinax), instead of coax, in high noise areas to cancel low frequency magnetic field cross-talk and hum.

*Digital applications* in the *computer* and *instrumentation* fields require good high-frequency design engineering when transmitting nanosecond rise time pulses. A 10 nanosecond rise time pulse is equivalent to 100 megahertz RF. Using good coax cabling techniques helps to avoid pulse reflection, false noise triggering or data inaccuracy.

Special care is required to keep noise from entering *information systems* (particularly aircraft). *Low level communication circuit* cabling should be space separated and have effective shielding from adjacent parallel power circuits to avoid induced hum.

*Unprotected circuits* (such as ordnance and timing) can receive false pulsing if exposed to external radiated RF interfering fields.

*High megawatt pulsed radar* will introduce both its carrier and pulsed radio frequency waveform into nearby sensitive low-level unprotected cable runs which act as receiving antennas.

## ELECTRONIC SYSTEMS WIRING & CABLE

Sometimes the transmitted pulses have amplitudes of hundreds of thousands of volts (as used in **atomic energy testing** or **linear accelerators**) thereby producing large magnetic and capacitive interference fields. These play havoc with local cable-connected instrumentation and electronic equipment. In the case of **nuclear attack**, a tremendous electromagnetic pulse (EMP), transmitted for many miles from ground zero, will induce extremely high voltages in all unguarded and unprotected cable and equipment.

It is estimated that a vertical electrical field intensity of 50K volts per meter will be present 62.5 miles from a 10-megaton near-ground explosion. Solid-state transistors and diodes, integrated circuits, front end RF coils, sensitive relays and reeds are typical of the sophisticated elements used today for both military and commercial systems that may fail even though far removed from the fireball area.

The lack of money, time and qualified personnel will not permit complicated and costly post-completion interference cleanup of poorly engineered systems. The use of good coax, twinax, triax, in isolated or guarded circuitry, will do much to suppress outgoing EMI and RFI, reduce incoming noise pickup, and help protect both your system and the adjacent system from mutual interference. Careful cable to equipment interface planning must be exercised to produce workable compatible systems. Design engineers are not free to treat cable installation as casually as they may have in the past.

### Coax Cable

Shielded cable should be used to protect against magnetic and capacitive stray fields in all cases of potential interference (low or high frequency). Grounded coax cable is excellent for use from 20 KHz to 5 GHz for most systems. But even coax, if subjected to very strong interference, will not completely protect the desired signal. Coax cable is a two conductor cable. The outer conductor of a coax cable is not a true shield in that it is also the signal return. A true shield is insulated from the signal carrying conductors and protects the enclosed coaxial conductors. However, the outer conductor of a coax cable is an electrostatic shield and thus protects against capacitive interference. When two conductors at different voltages are placed near one another, a charge difference exists between them. Since a charge difference exists between the two conductors, a capacitive effect also exists between them. Such capacitive effects can give rise to interference signals in both conductors.

To prevent wires which carry low-level signals from being influenced by capacitive effects, you need to surround the low-level signal wire with an electrostatic shield. This type of shielding is effective because external electric fields cannot penetrate an enclosure surrounded by an electrical conductor. Coax cable should be used when low-level signal wire is likely to come in contact with another signal carrying wire. This is especially true when the voltage difference between the signal carrying wire and the source of interference is large. Any external voltage injected in this braid will act as noise to the desired signal in the coax. The sophistication of cable and

equipment isolation techniques used is dependent upon the frequency of the interfering noise and how it enters the cable system. Any additional measures taken to reduce incoming noise will also reduce outgoing radiation and cross-talk.

### Ground Loops and Common Mode Returns

Coax cable consists of an inner and an outer conductor insulated from each other. Each conductor carries a desired signal current (source to load or return). The outer conductor is usually grounded at the source, load, bulkheads and other intermediate points. "Ground loop" or "common mode" currents caused by potential differences of external noise sources are also simultaneously carried on the outer conductors and noise is introduced into the system, greatly reducing the "signal-to-noise ratio."

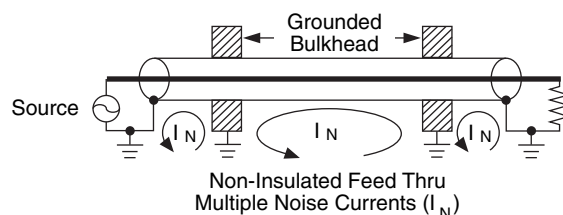

Low frequency signals (20 KHz to 6 MHz) are particularly susceptible to both ground loop and common mode interference. Coax cable is recommended in this case with the complete coax chain having a **minimum**-number of outer conductor ground contacts. Reducing the number of ground connections reduces the number of possible ground loops. Major equipment, relays, switches, connectors, patch panels, etc., should be **isolated from ground** with the ultimate design having only one system ground connection at the source.

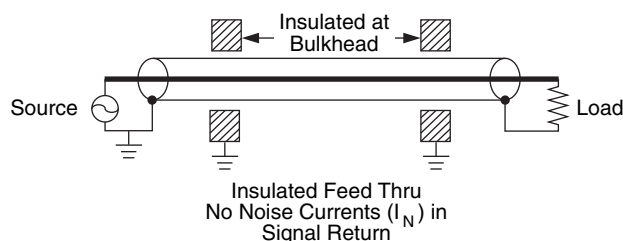

# ELECTRONIC SYSTEMS WIRING & CABLE

## Radiated Fields

Where strong radiated noise fields exist, such as **high powered radar, broadcast stations, power lines, fluorescent lighting, office and industrial machinery, multiple cable runs, etc.**, the cable conductors act as receiving antennas or secondary windings of transformers and pick up externally generated noise. At higher frequencies, a part of the energy associated with the fluctuating current of charge in a conductor is radiated away from the conductor in the form of electromagnetic radiation. Electromagnetic shields make use of the fact that the electromagnetic radiation must simultaneously contain electric and magnetic fields in order to propagate independently through space. Therefore, a shield designed to eliminate electrostatic fields can be used to neutralize the electric field component of an electromagnetic wave. Consequently the outer conductor of a coax cable connected to a ground through a low-impedance path will be an effective shield against electromagnetic interference.

In high-level RF environments, it is desirable to minimize the RF potentials existing between points on a coax shield. The shield should be grounded at both ends of the cable and at intermediate points along the cable. This multi-point grounding of the shield maintains the RF shielding effectiveness of the cable. If coax cable is used in a radiated interference area, the outer conductor should be grounded as often as possible and wherever feasible in order to remove the radiated interference as soon as possible. If your application requires that you address both ground loops and radiated interference, you may need to use either twinax or triax cable.

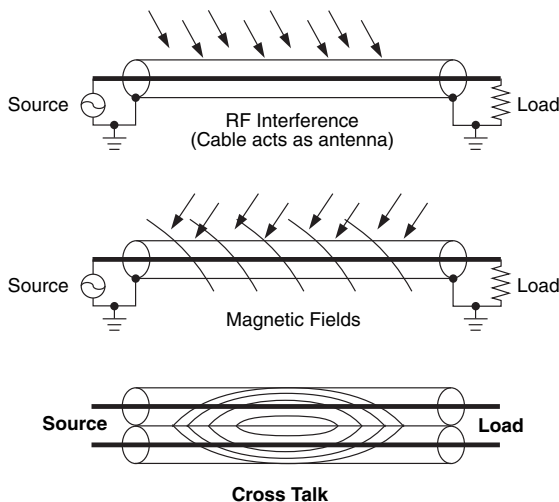

A particularly bad source of noise pickup is the induced currents (cross-talk) encountered in large multiple cable installations.

Two improved types of cables are used for additional protection against these radiated sources:

## Triax Cable

Triax cable is coax cable with an additional outer copper braid (insulated from the signal carrying conductors) that acts as a true shield and protects the enclosed coax conductors. This braid or shield is grounded and passes both ground loop and capacitive field noise currents away from the signal carrying coax, thereby greatly improving the “signal to noise” ratio over standard coax cable.

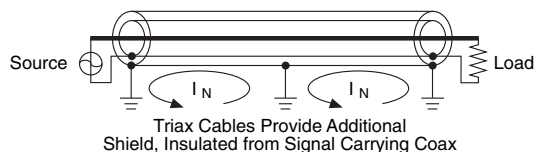

Triax cable is also used in “Driven Shield” applications where the inner conductor and *the first braid* are driven in parallel at the transmitting end and work against the outer braid which is insulated above ground. The inner braid is left floating at the receiving end, providing a “Faraday” shield between the inner conductor and outer braid. In this way the cable’s **distributed capacitance** is greatly reduced, thereby reducing cable losses and loading. This application is most effective in **high frequency transducer data systems** where the distributed capacity in coax cable limits the data accuracy. The two outer braids of the triax cable can be used as a low-impedance (approximately 12 ohms) transmission line to carry high-current pulses to **low impedance laser lamps or exploding bridge wire (EBW) ordnance systems**. Triax cable and connectors completely **insulated** from the ground are available for these applications.

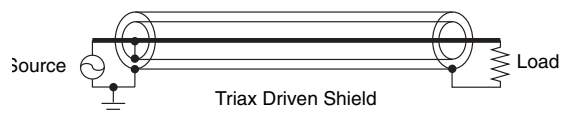

## Twinax Cable

Twinax cable is a two-conductor twisted balanced wire line with a specific impedance and a shielding braid around both wires. The twisting of the two balanced-signal-carrying wires cancels any random induced noise voltage pickup, giving protection against any low frequency magnetic noise passing through the copper braid. **Trompeter’s twinax cable design** also lowers cable losses by adding two (2) dielectric fillers under the braid which separates the braid away from the signal pair, thereby lowering the leakage capacitance to ground. Additionally, the coverage is improved to 90% by using more copper wire in the braid and weaving it tighter. Like triax cable, Trompeter’s twinax cable provides protection against ground loops and capacitive fields. Twinax cable usefulness, however, is limited to approximately 15 MHz since it has rather high transmission losses above this frequency. Twinax cable and concentric connectors are available for low frequency, digital and video distribution systems.

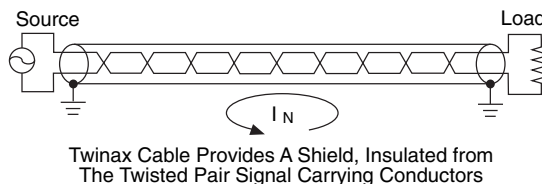



## ELECTRONIC SYSTEMS WIRING & CABLE

### Bonding & Grounding

Good bonding and grounding are absolutely essential if noise pickup reduction is to be accomplished. Equipment isolation, cabling, bonding, and grounding are all part of the noise pickup and EMI/RFI problem. The method of equipment interconnecting and grounding is a function of the signal frequency and no one simple answer can be provided. The following common conditions require detailed consideration:

- **“Earth” grounds:** require extensive grids, ground rods, and chemical preparation to obtain an extremely low resistance and impedance system ground return.
- **Ground isolation:** In many instances in low-frequency data systems where equipment is widely separated, equipment ground “planes” should be isolated from earth grounds to avoid “noisy” ground loops caused by power and other equipment in the immediate area.
- **Parallel cabling:** Space isolate cabling of similar functions ( i.e., RF from RF, video from video, and cables carrying vastly different voltage levels) so that they do not have mutual capacitive or inductive coupling.
- **Termination impedance:** Properly terminate all pulse and high-frequency cables in their characteristic impedance so that the cable reactive components are cancelled out and the voltage standing waves are reduced to a minimum.
- **Cable selection:** The higher the frequency, the faster the pulse rise time, or the longer the cable run; the bigger the cable required to reduce dielectric losses and lessen the distortion of pulse shapes.
- **Grounding location:** If “system” ground and “earth” ground must be connected, it should be done at minimal locations (preferably one) using extremely low-impedance bonding paths and materials. Otherwise, RF and high-frequency bonding should be made frequently to provide the shortest RF path to ground and to prevent the ground return from acting as an additional length of antenna.

### Systems Usage

Most engineers are quite familiar with the longtime use of 75 ohm coax cable in *baseband telephone transmission* installations and its universal use for *broadcast* and *cable TV*. Coax and twinax cables are being used for *local dedicated installations* with the rapid growth of *commercial computer data distribution*. The non-dedicated commercial coax data bus systems (*Ethernet*) tie many terminals to one high bit-rate trunk cable. *Military aircraft systems* call for 78 ohm twinax data bus distribution for main functions of *guidance* and *control, navigation, communications*, etc., per **MIL–STD–1553B** (TRs and TRB series connectors). **MIL–STD–1397** specifies 50 ohm triax in naval ship digital data bus applications which use the TRB and TRC series connectors listed in **MIL–C–49142**.

Interference is becoming a major problem with the proliferation of *digital computer* installations, *data transmission* systems, and *local area networks* (both baseband and broadband). The main

interference encountered is caused by the high harmonic content of the digital pulses that fall in the RF region and radiate into free space or cross-talk to other victim cables.

### Choice of Cable Type and Installation:

- **Grounded Coax:** Can pass the high information rates, but is subject to ground loops as well as magnetic and radiated noise pickup.
- **Ungrounded Coax:** Can pass the high information rates, but is subject to magnetic and radiated noise pickup. Substantially lowers the ground loop interference.
- **Triax Cable:** Can pass the high information rates, but is subject to magnetic noise pickup. Substantially lowers the ground loop interference and removes the radiated noise.
- **Twinax Cable:** Passes only medium information rates, but hinders the pickup of magnetic interference due to the “twist” of the signal pair. (Equipment usually operated with balanced inputs and outputs.)
- **Ungrounded versions of Twinax and Triax:** Provide even more ground loop isolation.

The choice of materials to be used in these cables is of major importance. For *commercial installations in public buildings*, the National Electrical Code, Underwriters Lab and local ordinance requirements must be complied with. *Fire wicking cables* routed horizontally through fire walls and vertically floor-to-floor are required to be metal ducted (a very expensive and inflexible mode of construction). *Approved cables made of FEP* can be routed horizontally and vertically, without ducting, in air plenums with a great reduction in size and cost and with much **greater flexibility for future modifications**. Increasing insurance premiums will almost dictate that **flame retardant nontoxic materials** be used in all future public building cable installations to reduce potential loss of life and property. The same applies to *military aircraft cables* which must also be able to withstand exposure to fuel and cleaning solvents. Connectors are available for these special cables.

**Trompeter Electronics, Inc.** has developed coax connectors that are isolated above ground, but have a 6 nanofarad bypass capacitor, shunting the outer braid to ground for high harmonic attenuation. In many instances, interference can be so severe that twinax (balanced-shielded) or triax (shielded coax) cables must be used along with the proper connectors to provide good isolation, bonding and grounding.

As previously discussed, high bit-rate signals require high-frequency transmission cables (coax, twinax, triax and even quadax) to minimize amplitude and frequency distortion and to prevent noise pickup from external interference.

The *design engineer* must select the optimum cable and connectors for maximum reduction of interference due to radiated RF and magnetically coupled or direct contact ground loop noise. This can reduce the number of noise suppression filters and amplifiers required.

A repeated word of caution is offered for those contemplating “digital” use. Low-voltage digital lines should not be placed in the near proximity of high-voltage and high current cables. Nor should a single multifunction connector be used due to the strong probability of cross-talk coupled interference. Physical separation of the cables is the first and best solution, with shielding and isolation above ground being the second consideration. ■

# CUSTOM PRODUCTS REQUEST FORM

Fax: 480-985-0334

## Product Request Form

Make a copy of this page and keep it as a master form.

Date Submitted: \_\_\_\_/\_\_\_\_/\_\_\_\_

*Important:* Please provide us with as much information as possible, so that we may respond to your requests quickly and accurately.

Company: \_\_\_\_\_ Contact: \_\_\_\_\_  
 Address: \_\_\_\_\_ Phone: \_\_\_\_\_  
 \_\_\_\_\_ Fax: \_\_\_\_\_  
 \_\_\_\_\_

Description: \_\_\_\_\_ Price Range: \_\_\_\_\_  
 \_\_\_\_\_  
 \_\_\_\_\_  
 Operating Conditions: \_\_\_\_\_  
 \_\_\_\_\_  
 \_\_\_\_\_

Similar to:  Yes  No      Drawing attached?  Yes  No  
 Drawing available?  Customer Spec #:  
 Is there a spec?  Other Spec #:  
 Quantity: \_\_\_\_\_ When needed? \_\_\_\_\_

Product Features: \_\_\_\_\_  
 \_\_\_\_\_  
 \_\_\_\_\_  
 \_\_\_\_\_  
 \_\_\_\_\_

Application Notes: \_\_\_\_\_  
 \_\_\_\_\_  
 \_\_\_\_\_  
 \_\_\_\_\_  
 \_\_\_\_\_

## APPENDIX PART NUMBER INDEX

Part Number	Page	Part Number	Page	Part Number	Page
ACA-Δ-0	81	(U)BJ46GF	43	(U)BJ228	30
ACB013-	81	(U)BJ47	40	(U)BJ229	30
ACC-Δ	81	(U)BJ48	39	(U)BJ246	40
AD1	56	(U)BJ48GF	43	BJ246GF	43
AD131	45	(U)BJ49	40	(U)BJ249	40
AD1300	45	BJ50(FL)	49	BJ330	27
ADAPTERS	68-71	BJ51(GL)	49	BJ331	27
AD1W	56	BJ57	49	BJ338	27
AD1WHD	56	BJ58(FL)	49	BJ339	27
ADH1	56	BJ59(FL)	49	BJ350	49
ADH1W	56	BJ72(TL/FL)	9	BJ357	49
ADMW12	56	BJ73(TL/FL)	9	BJ358	49
(U)AD28	29	BJ74(TL/FL)	9	BJ359	49
(U)AD228	29	BJ74C	9	BJ372	9
(U)AD48	39	BJ74C(TL/FL)	9	BJ373	9
AD78 (TL/FL)	8	BJ75(TL/FL)	9	BJ73HS	18
(U)AD95	44	BJ76(TL/FL)	9	BJ374	9
AD158(FL)	22	BJ77(TL/FL)	9	BJ374C	9
(U)ADI95	44	BJ77HS	18	BJ375	9
AD378	8	BJ78(TL/FL)	9	BJ376	9
AD3158	22	BJ78HS	18	BJ376HS	18
ADRMF70(TL/FL)	8	BJ79(TL/FL)	9	BJ377	9
ADRMF370	8	BJ79C(TL/FL)	9	BJ378	9
UADRMF220	29	BJ79HS	18	BJ578HS	18
ALP3	58	BJ80	26	BJ379	9
APC3	58	BJ83	26	BJ379C	9
APC(D)B-L	58	BJ89	26	BJ380	26
ALPL3	58	BJ89F	26	BJ383	26
AVPC-L-50	58	BJ92	45	BJ388	26
AVPCL-L-50	58	BJ95F	44	BJ389	26
AVPCW-L-75	58	(U)BJ95	44	BJ389F	26
AVPCLW-L-75	58	(U)BJ96	44	BJ450	24
AT1	74	(U)BJ98-2	44	BJ457	24
AT2	74	(U)BJ120	41	BJ459AC	25
AT4	74	(U)BJ120SL	41	BJ770(GL)	9
AWC	72	(U)BJ120C	41	BJ803	26
AWS	72	BJ150(FL)	21	BJ833	26
(U)BJ20	30	BJ151	22	BJ88	26
(U)BJ20SL	30	BJ152(FL)	21	BJ883	26
(U)BJ21	30	BJ153(FL)	21	BJ893	26
(U)BJ23	30	BJ154(FL)	21	BJ893F	26
(U)BJ24	30	BJ154AC(FL)	21	BJ3150	21
(U)BJ26	30	BJ155(FL)	21	BJ3150HS	18
(U)BJ26GF	43	BJ157(FL)	21	BJ3150SHS	18
(U)BJ27	30	BJ157F(FL)	21	BJ3152	21
(U)BJ28	30	BJ157FLHS	18	BJ3153	21
(U)BJ28GF	43	BJ157HS	18	BJ3154	21
(U)BJ29	30	BJ158(FL)	21	BJ3154AC	21
BJ30	27	BJ159	20	BJ3155	21
BJ31	27	BJ159AC	20	BJ3157	21
BJ38	27	BJ159ACFL	20	BJ3157F	21
BJ39	27	BJ159FL	20	BJ3158	21
(U)BJ40	40	(U)BJ220	29	BJ3159	20
(U)BJ40SL	40	(U)BJ224	30	BJ3159AC	20
(U)BJ41	40	(U)BJ224-RIA	30	BJ3450	24
(U)BJ46	40	BJ226GF	43	BJ3457	24

Δ See Cable Group Table, pages 82-124. (U) = denotes 75 ohm version available. Call Factory for part numbers not listed.



Part Number	Page
BJ3459AC	.25
(U)BN23	.29
BN73(TL/FL)	.11
BN83	.26
BN153(FL)	.22
BN373	.11
BN383	.26
BN833	.26
BN3153	.22
BNC Attenuator	.43
BWC	.72
BWS	.72
BWS/C26T3D	.72
BWS/C26T3E	.72
C26T2(A-U)	.72
C26T3(A-U)	.72
CRIMP DIES	.73
CD3-	.73
CD5-	.73
STANDARD COAX CIRCUIT BOARD JACKS	.31-36
MINIATURE COAX CIRCUIT BOARD JACKS	.37-40
TWINAX/TRIAX CIRCUIT BOARD JACKS	.8-10, 18, 22, 26-27
(U)CJ20	.29
(U)CJ40	.39
(U)CJ50	.49
CJ50FL	.49
CJ70(TL/FL)	.8
CJ70C(TL/FL)	.8
CJ80	.26
CJ150	.20
CJ150AC	.20
CJ150ACFL	.20
CJ150FL	.20
(U)CJ220	.29
(U)CJ240	.39
CJ350	.49
CJ370	.8
CJ370C	.8
CJ380	.26
CJ450AC	.25
CJ3150	.20
CJ3150AC	.20
CJ3450AC	.25
CRIMP TOOLS	.73
CT3	.73
CT4L	.73

Part Number	Page
D HOLES	.63
DIN CONNECTORS	.42
DISTRIBUTION PANELS	.61
F CONNECTORS	.45-47
GROUND FILTER	.43
HOLE PLUGS	.60
IMPEDANCE MATCHING ADAPTER	.43
MINI-WECO COAX PATCH JACKS	.50, 52, 57, 59
STANDARD COAX PATCH JACKS	.51-55, 58
MINI-WECO COAX PATCH PLUGS	.56
STANDARD COAX PATCH PLUGS	.56
J11	.57
J11MW	.57
J11MWL	.57
J11D	.57
J12	.57
J13-R	.63
J13C-R	.55
J13WC-R	.55
J13H-R	.55
J13W-R	.55
J13WH-R	.55
J14 SERIES	.53
J15 SERIES	.53
J24WMSTHF-75	.53
J70	.13
J72	.13
J72D	.13
J72L	.14
J72S	.13
J72SM	.14
J74-2T-R	.15
J74MST-R	.15
J74T-R	.15
J94	.48
(U)J95	.44
J150	.16
J152(FL)	.16
J158	.16
J308	.16
J3152	.16
HDVDP/HDVDPM SERIES	.50
J315W SERIES	.52

Part Number	Page
JS - STANDARD NON-INSULATED PANELS	.63
JSI - STANDARD INSULATED PANELS	.63
JSIB - STANDARD INSULATED PHENOLIC PANELS	.63
JS - MINIATURE NON-INSULATED PANELS	.62
JSI - MINIATURE INSULATED PANELS	.62
JSIX - MINIATURE INSULATED PHENOLIC PANELS	.62
JSISM-60	.14
JSISM-120	.14
STANDARD COAX LOOPING PLUGS	.58
STANDARD TWINAX/TRIAX LOOPING PLUGS	.17
SUBMINIATURE TWINAX/TRIAX LOOPING PLUGS	.17
MINI-BNC CONNECTORS	.38
M22520/1-01	.73
M22520/2-01	.73
M22520/5-01	.73
MP20W	.52
N CONNECTORS	.44-45, 48
(U)PL95	.44
COAX PATCH CORDS	.58-66
TWINAX/TRIAX PATCH CORDS	.13-14, 16
For Part Numbers Not Listed Call Factory	
Visit Our Website: <a href="http://www.trompeter.com">www.trompeter.com</a>	

Δ See Cable Group Table, pages 82-124. "D" Mounting holes are on page 63. (U) = denotes 75 ohm version available.

## APPENDIX PART NUMBER INDEX

Part Number	Page	Part Number	Page	Part Number	Page
(U)PL20	.29	PL3155AC	.20	TROMPETER CABLE SPECS	56-57
(U)PL21	.29	PL3455AC	.25	010-0043	.73
(U)PL21SL	.29	UPLFF220	.29	010-0044	.73
PL30	.27	PLPA330	.27	010-0045	.73
(U)PL40	.39	PLR74C	.8	010-0055	.73
(U)PL41	.39	PLR75C	.8	010-0070	.73
(U)PL41SL	.39	PLR75CFL	.8	010-0080	.73
PL50	.49	PLR155AC	.20	010-0088	.73
PL50C	.49	PLR155ACFL	.20	010-0096	.73
PL50FL	.49	UPLR220	.29	010-0097	.73
PL53	.49	PLR375C	.8	010-0098	.73
PL71	.13	PLR455AC	.24	010-0108	.55
PL71L	.14	PLR3155AC	.20	010-0123	.74
PL73	.8	PLR3455AC	.24	010-0133	.74
PL73C	.8			105-1374	.73
PL74	.8	PARELLELING		105-1636	.73
PL74MC(FL)	.8	ADAPTERS	.54	105-1663	.73
PL74C	.8			105-1885	.73
PL75	.8	RFI CAPS, COAX	.67	155-0830-1	.14
PL75C	.8	RFI CAPS, TWINAX	.12		
PL75CFL	.8				
PL75FL	.8	REMOVAL TOOLS	.75		
PL75MC	.8	RT1L	.75		
PL80	.26	RT1XL	.75		
PL93	.48	RT1S	.75		
PL94	.48	RT1SS	.75		
U(PL95)	.44	RT4L	.75		
(U)PL121	.41	RT4S	.75		
(U)PL121SL	.41	RT5L	.75		
(U)PL122	.41	RT5S	.75		
(U)PL123	.41	RT5XL	.75		
PL150	.70	RTC-1L	.75		
PL151	.22	RTC-4L	.75		
PL153	.22	RTR-1L	.75		
PL153AC	.22	RTR-1XL	.75		
PL155	.20				
PL155FL	.20	SP450AC	.25		
PL155AC	.20	SPC8P-201	.19		
PL155ACFL	.20	SPC8S-201	.19		
(U)PL220	.29	ST1	.72		
(U)PL240	.39	STC-F	.72		
PL330	.27	STC-W	.72		
PL350	.49				
PL375	.8	TERMINATORS, COAX	.67		
PL375MC	.8				
PL375C	.8	TERMINATORS, TWINAX/TRIAX	.12		
PL380	.26				
PL455AC	.25	TOOLS	.72-75		
PL803	.26				
PL3155	.20				

For Part Numbers Not Listed  
Call Factory

Visit Our Website:  
[www.trompeter.com](http://www.trompeter.com)

Δ See Cable Group Table, pages 82-124. "D" Mounting holes are on page 63. (U) = denotes 75 ohm version available.

## Emerson Network Power Connectivity Solutions

Trompeter  
5550 E. McDowell Road  
Mesa, AZ 85215  
USA

Tel: 480.985.9000

Fax: 480.985.0334

[www.trompeter.com](http://www.trompeter.com)

## About Emerson Network Power Connectivity Solutions

Emerson Network Power Connectivity Solutions, an Emerson business, serves the needs of wireless communications, telephony and data networks, CATV, security systems, health care and industrial facilities with a full spectrum of broadband copper and fiber optic connectivity products. For more information, visit [www.EmersonNetworkPower.com/Connectivity](http://www.EmersonNetworkPower.com/Connectivity).

## About Emerson

Emerson (NYSE: EMR), based in St. Louis, is a global leader in bringing technology and engineering together to provide innovative solutions to customers through its network power, process management, industrial automation, climate technologies, and appliance and tools businesses. For more information, visit [www.gtoemerson.com](http://www.gtoemerson.com).

## Emerson Network Power.

The global leader in enabling business-critical continuity.

- AC Power Systems
- Embedded Power
- Outside Plant
- Connectivity
- Inbound Power
- Precision Cooling
- DC Power Systems
- Integrated Cabinet Solutions
- Site Monitoring and Services

[www.EmersonNetworkPower.com](http://www.EmersonNetworkPower.com)